

Features

- 33-inch minimum base cabinet width.
- Single bowl.
- 9" depth provides generous workspace.
- Single faucet hole.
- Bowl slopes 2 degrees toward drain to minimize water pooling.
- Offset drain increases workspace in the sink and storage space underneath.
- Includes K-6239 colander with integral cutting board and K-6237 left-hand bottom sink rack.

Material

- KOHLER® enameled cast iron.

Installation

- Top-mount.

Recommended Products/Accessories

K-6237 Left-Bowl Sink Rack
K-6255 Right-Bowl Sink Rack
K-8801 Sink Strainer
K-8799 Sink Strainer
K-23726 Drain treatment
K-23725 Cast iron cleaner

Optional Products/Accessories

K-6194 Utility Rack With Soaking Cup
K-6246 Cutting Board
K-11352 Disposal Flange with Stopper
K-9000 P-Trap

Included Components

Product consists of:

K-6239 Colander with Cutting Board
K-6237 Left-Bowl Sink Rack



Codes/Standards











ASME A112.19.1/CSA B45.2

KOHLER® Enameled Cast Iron Kitchen Sink Lifetime Limited Warranty

See website for detailed warranty information.

Available Colors/Finishes

Color tiles intended for reference only.

Color	Code	Description
	0	White
	FF	Sea Salt™
	96	Biscuit
	47	Almond
	FD	Cane Sugar™
	95	Ice™ Grey
	G9	Sandbar
	K4	Cashmere
	KA	Black 'n Tan
	7	Black Black™

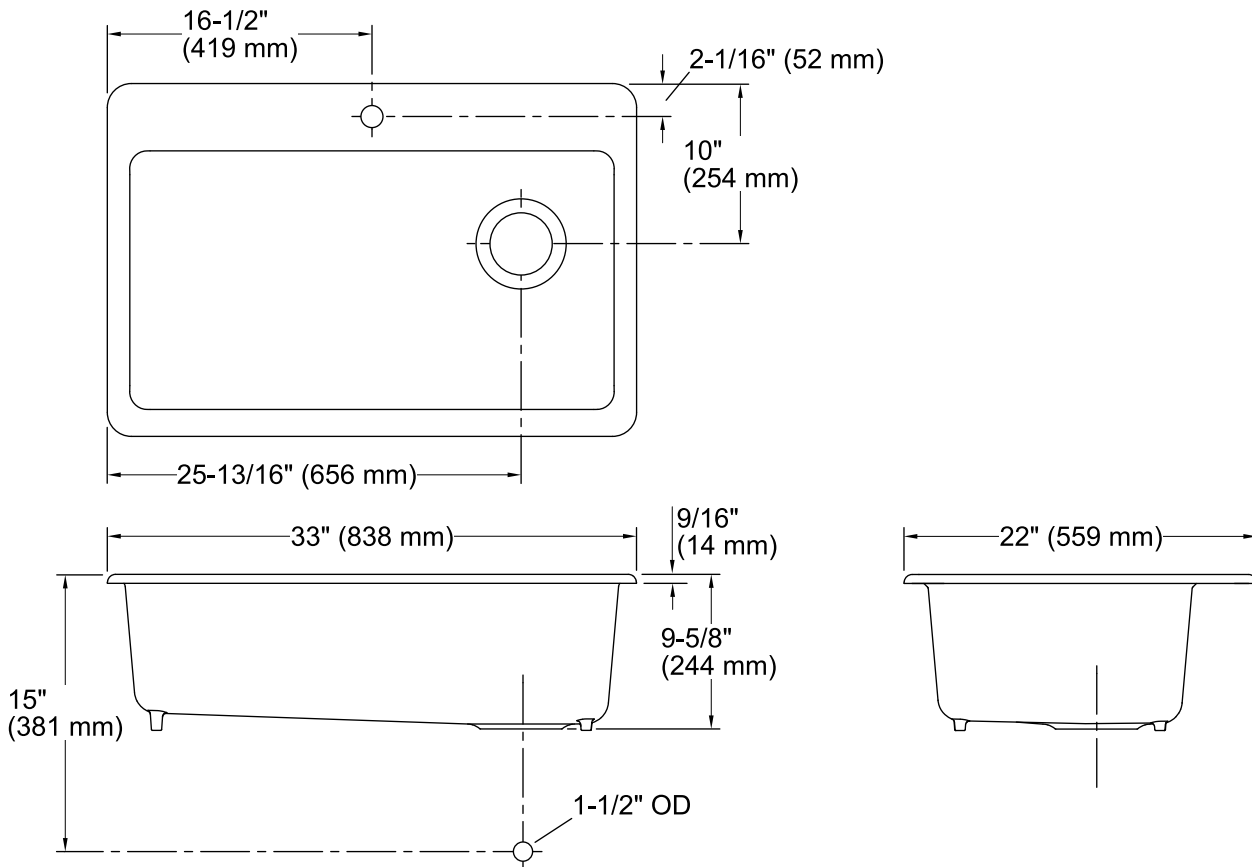

Technical Information

All product dimensions are nominal.

- Bowl configuration: Single
- Installation: Top-mount
- Min. base cabinet width: 33" (838 mm)
- Bowl area (Only): Length: 30-1/4" (768 mm)
 Width: 15-13/16" (402 mm)
 Bowl depth: 9" (229 mm)
- Number of deck holes: 1
- Faucet hole(s): 1-3/8" (35 mm)
- Drain hole: 3-7/8" (98 mm)
- Template: 1166727-7, required, included

Notes

Install this product according to the installation instructions.

NOTICE: Countertop manufacturer or cutter must use the cut-out template provided with the product, or a current one provided by Kohler Co. (call 1-800-4-KOHLER). Kohler Co. is not responsible for cutout errors when the incorrect cut-out template is used.