

Features

- Rectangular basin.
- No faucet holes; requires wall- or counter-mount faucet.
- Overflow drain.

Material

- KOHLER® enameled cast iron.

Installation

- Drop-in or under-mount.

Optional Products/Accessories

52047 Clamp Accessory Pack, 4 Ea.

Included Components

Additional Components:

1193643 Basin clamps



ADA

CSA B651

Codes/Standards

ASME A112.19.1/CSA B45.2

ADA

ICC/ANSI A117.1















CSA B651

Lifetime Limited Warranty for KOHLER® Cast Iron Components

See website for detailed warranty information.

Available Colors/Finishes

Color tiles intended for reference only.

Color	Code	Description
	0	White
	FF	Sea Salt™
	96	Biscuit
	47	Almond
	FD	Cane Sugar™
	NY	Dune
	G9	Sandbar
	KC	Vapour™ Blue
	KG	Vapour™ Green
	K4	Cashmere
	FT	Basalt
	20	Suede
	KA	Black 'n Tan
	7	Black Black™

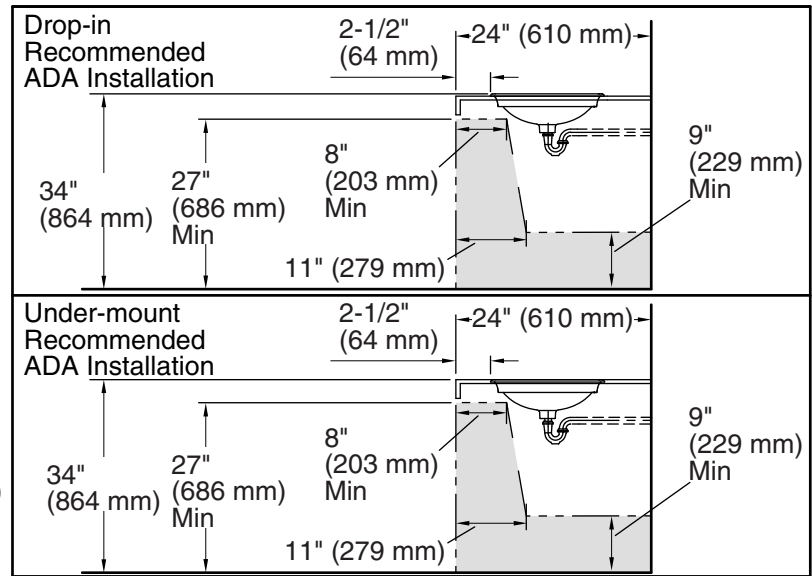
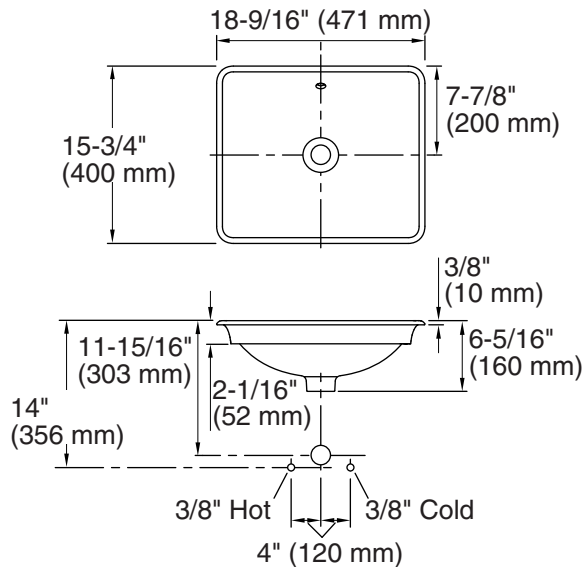

Technical Information

All product dimensions are nominal.

Bowl configuration:	Single
Installation:	Drop-in, Under-mount
Bowl area (Only):	Length: 17-1/2" (445 mm) Width: 14-3/4" (375 mm) Bowl depth: 4-9/16" (116 mm) With overflow: Yes Water depth: 2-15/16" (74 mm)
Template:	1222632-7, required, included

Notes

Install this product according to the installation instructions.

NOTICE: Countertop manufacturer or cutter must use the cut-out template provided with the product, or a current one provided by Kohler Co. (call 1-800-4-KOHLER). Kohler Co. is not responsible for cutout errors when the incorrect cut-out template is used.

ADA, CSA B651 compliant when installed to the specific requirements of these regulations.