

Assembly Instruction Sheet #IS-9904C16 For Style 9904C16

Tools Required: Flathead screwdriver, Phillips screwdriver, pliers, wire cutters, wire strippers, electrical tape, safety glasses.
Light Source: (3) E26 Base Bulb 60W Maximum (Not Include).
Preparation: Identify and inspect all parts before beginning installation. Check package content list and diagrams below to be sure all parts are present. If any parts are missing or damaged, do not attempt to assemble, install, or operate the fixture. Contact customer service for replacement parts.

⚠ Warnings and Cautions

Turn off electricity at circuit breaker or main fuse box before installation. Consult a licensed electrician if in doubt. These instructions are provided for your safety. It is very important you read them completely before installing the fixture. We strongly recommend that a licensed, professional electrician perform the installation. Disconnect fixture from power source before replacing bulbs. Make sure bulbs are given sufficient time to cool before removal.

Package Contents

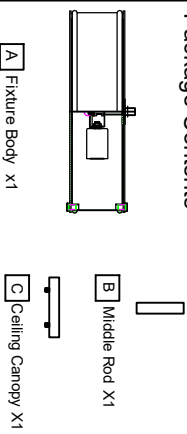

PART	DESCRIPTION	QUANTITY
BB	W/nut	2pcs
CC	Outlet Box Screw	2pcs



STEP 1 – Install Rods to Fixture Body

A. Thread the power cord to the Middle Rods, fix the Middle Rods with the fixture body then the same to connect the other pieces of Rods, finally fix the Canopy with the Rods.

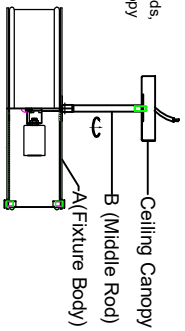

Figure 1

STEP 2 – Attach Mounting Screws, Lock Washers and Hex Nuts to Mounting bracket.

A. Line up a set of holes on the Mounting bracket (EE) and Holes on the ceiling canopy. Thread Mounting Screws (DD) into the holes on the Mounting bracket (EE). Pass Lock Washers and thread Hex Nuts onto the Mounting Screws (DD). Hand tighten until snug.

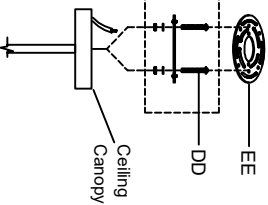

Figure 2

STEP 3 – Attach Mounting bracket to Outlet Box

A. Pass the supply wires through the Mounting bracket (EE). Attach the Mounting bracket (EE) to the Outlet Box with the head of the Green Ground Screw facing you. Secure it with Outlet Box Screws. Tighten until snug.

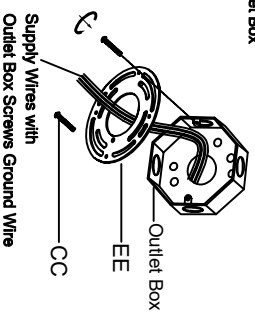

Figure 3

STEP 4 – Fit Ceiling Canopy to Mounting bracket Assembly

A. Fit the ceiling canopy to Mounting Screws (DD) and secure with Cap nut (AA). Note: The ceiling canopy should be snug against the ceiling and the Cap nut (AA). If not, adjust the length of the Mounting Screws (DD) by unscrewing the Hex Nut and Lock Washer and then screwing Mounting Screws (DD) in or out of the Mounting bracket (EE) until the correct length is achieved. Once the ceiling canopy is secure, remove the Cap nut (AA) and ceiling canopy and proceed to Step 5.

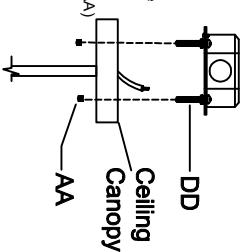

Figure 4

STEP 6 – Install Ceiling Canopy to Ceiling

A. Carefully tuck all wires into the outlet box and position the ceiling canopy of the Fixture Body (A) over the outlet box. Align the holes in the ceiling canopy with the Mounting Screws (DD). Secure with Cap nut (AA) and hand tighten until snug.

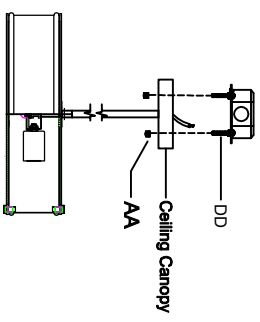

Figure 6

STEP 5 – Wire Connections

A. Use standard wire connectors to make all wire connections. Twist connectors until wires are tightly joined together. Wrap each connection with approved electrical tape and carefully stuff all the connected wires into the Outlet Box.

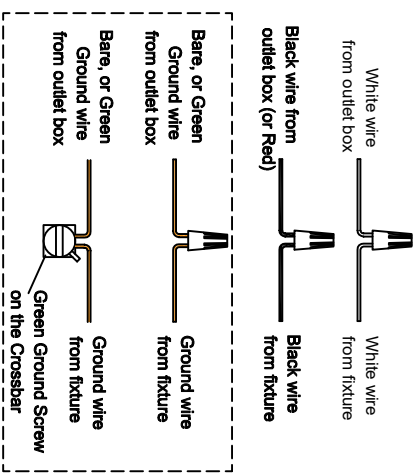

Figure 5

STEP 7 – Install bulb

A. Loosen the bottom screen.
 B. Install bulbs into sockets and screw snug into place.
 C. Screw up the screen.

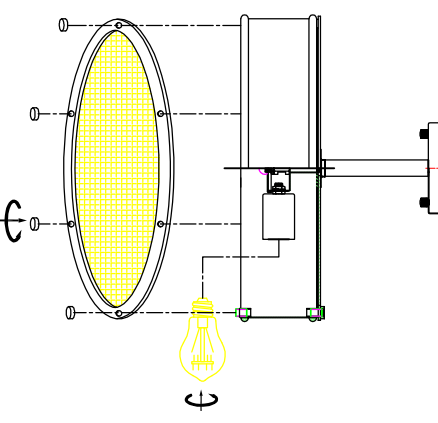

Figure 7