

Owner's Manual And Assembly Instructions

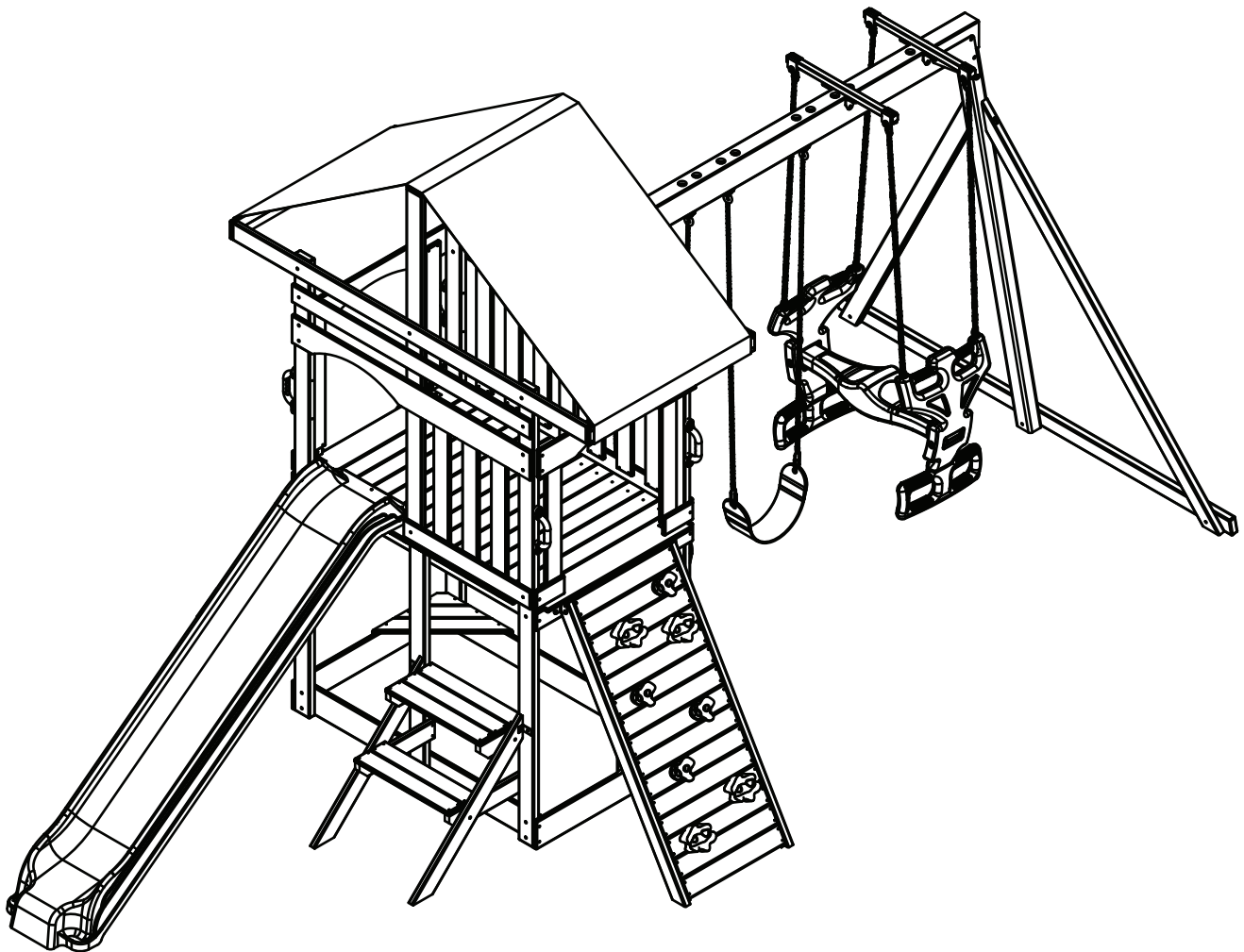

SKY VIEW GYM

Model: 3101



●.....●

**Thank you for purchasing a
Creative Cedar Designs
Playcenter. We hope it will
bring you and your children
many years of safe and
enjoyable backyard fun.**

●.....●

Table of Contents

Letter to Customer	2
Positioning Your Playcenter	3
Tools Required for Assembly	3
Helpful Installation Hints	4
Operating Instructions	5
Maintenance Instructions	6
Disposal Instructions	6
CPSC Information Sheet	7
Assembly Instructions	9
Limited Warranty	37
Warranty Claim Procedure	38
Customer Registration Card	39

●.....●

**Your owner's manual should be read carefully
before starting assembly.**



STOP...PLEASE READ!!

IF YOU HAVE ANY QUESTION OR ARE MISSING A PART, PLEASE DO NOT CONTACT THE RETAILER THAT YOU PURCHASED THIS PRODUCT FROM. PLEASE VISIT

www.creativecedardesigns.com

OR CONTACT US DIRECTLY AT OUR OFFICE, 1-888-363-4967

WE WILL ANSWER YOUR QUESTIONS, OR HELP WITH WHAT YOU NEED.

For more efficient service, please log onto our website at

www.creativecedardesigns.com

and fill out a request for missing or damaged parts. A completed product registration is also necessary for all warranty claims.

For all international customers, please visit the following website for information on all warranty issues including where to obtain replacement parts.

www.creativecedardesigns.com

Dear Customer:

Thank you for purchasing a Creative Cedar Designs Playcenter. We hope it will bring you and your children many years of safe and enjoyable fun. Creative Cedar Designs equipment is recommended for use by **children 3 to 10 years of age**. Creative Cedar Designs structures are **not intended for public use**. **Creative Cedar Designs does not warranty any of its residential structures subjected to commercial use.**



WARNING: This Symbol points out important safety instructions which, if not followed, could endanger the personal safety of yourself and your children and/or damage your property. You **MUST** read and follow all instructions in this manual before attempting to use this playcenter.



WARNING: Children must **NOT** use this playcenter until unit has been completely assembled and inspected by an adult to insure set has been properly installed.

Please follow all recommendations below. **Failure to do so may result in the warranty being void and/or safety violations that could result in serious injury.** The following information has been provided to help you in your installation, continued satisfaction, and safe operation of your Creative Cedar Designs purchase.

Always keep the safety of your children in mind as your play structure is being built and as your children play on the set. Before your children play on the set please review the Operation Instructions with them to help ensure their safety.

PLEASE RETAIN THESE INSTRUCTIONS FOR FUTURE REFERENCE. KEEP THEM IN A SAFE PLACE WHERE YOU CAN REFER TO THEM AS NEEDED. IN ORDER TO PROVIDE YOU WITH THE MOST EFFICIENT SERVICE, IT IS REQUIRED THAT YOU PROVIDE US WITH THE PART NUMBERS WHEN ORDERING PARTS.

Please do **NOT** return the playcenter to the retailer from which it was purchased, without first contacting Customer Service.

General Information:

Please take time and fill out the information below. This information will be needed for warranty issues.

Date of Purchase: _____ **Date stamped on box:** _____

Manufacturer: Creative Cedar Designs **Retailer:** _____
2700 Riverside Dr. _____
Chattanooga, TN 37406 _____

E-mail: custservice@creativecedardesigns.com

Website: www.creativecedardesigns.com

Unit Type:

Unit Name: Sky View

Revision Date: 08/08/2020

Unit Model Number: 3101













The instructions and owner’s manual for your new Playcenter should be read in its entirety before assembly, to minimize problems and safety issues. We recommend reading the owner’s manual thoroughly after you have identified all of the parts for your Playcenter as discussed in the Helpful Installations Hints section below.

Positioning Your Play center

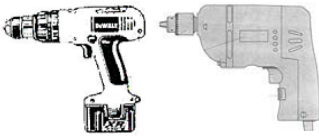
1. The Playcenter is designed to be installed on a level surface **by an Adult with an Adult helper**. Try to place in a flat area of your yard to minimize ground preparation.
2. Choose a level location for the equipment. This can reduce the likelihood of the play set tipping over and loose-fill surfacing material washing away during heavy rains.
3. Place the equipment not less than 6 ft from any structure or obstruction such as a fence, garage, house, overhanging branches, laundry lines, or electrical wires.
4. Provide enough room so that the children can use the equipment safely. For example, for structures with multiple play activities, a slide should not exit in front of a swing.
5. It is a good idea to place your Playcenter in an area that is convenient for adults to watch children at play.
6. Create a site free of obstacles that could cause injuries – such as low overhanging tree branches, overhead wires, tree stumps and/or roots, large rocks, bricks and concrete. We have additional suggestions in the Suggested Playground Surfacing Section.
7. Do not build your playset on top of surfacing material.
8. Locate bare metal platforms and slides out of direct sunlight to reduce the likelihood of serious burns. A slide that faces north will receive the least direct sunlight.
9. Separate active and quiet activities from each other. For example, locate sandboxes away from swings or use a guardrail or barrier to separate the sandbox from the movement of the swings.

Tools Required for Installation:

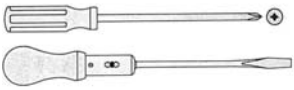
(These are the tools that are generally required for assembly of our playsets. These tools are not included in the playset purchase.)

			
(Level 24")	(Open end Wrenches 1/2" & 7/16")	(Nut drivers 1/2" & 9/16")	
			
(Tape Measure)	(3/8" Drive Ratchet, 1/2" & 9/16" std sockets 1/2" & 9/16 deep sockets)	(Claw Hammer)	
			
(3/8" drill)	(1/8", 5/16" & 3/8" Drill bits)	(Drill attachments: 3/8" drill bits) (3/8" Socket Driver Torque head screw)	Ladder
			
(An Adult w/an Adult helper)	(Phillips & Straight Blade screw drivers)	(Rubber Mallet –Optional)	

Helpful Installation Hints

1. Depending on your experience, assembly of this Play set should take approximately 6 to 12 hours after inventory of parts. Therefore, we recommend you set aside a full day for assembly.
2. Identify all of the parts for your Playcenter. Empty each box and lay out boards so you can see each part. Your instruction book will have detailed drawings that will make it easy for you to recognize individual parts. Keep all hardware and metal parts separate from wooden pieces.
3. After everything is laid out, check carefully to ensure all parts are present. Make sure there are no broken boards.
4. Find an area to sort your hardware. It is best to open the hardware on a solid surface so that you do not lose any pieces in the grass. This will save time and familiarize you with all the different pieces in the hardware bag.
5. Important note: Wood has some natural defects such as knots, surface cracks, etc... We reject parts that are structurally defective. We use a high quality lumber in our structures; however, you should inspect each part for splinters or rough spots and sand them smooth to prevent injury.
6. After steps 1 thru 4 have been completed, read all the way through the instructions completely. Reading instructions after you have studied the parts will help you understand more clearly the installation process, and help to eliminate unnecessary mistakes.
7. Pay close attention to the diameter and length of each bolt and screw.
8. Swing hangers should be buried past the threads, so that the loop is against the swing beam. Creative Cedar Designs is not responsible for incorrect installations of swing hangers. Failure to properly install swing hangers may cause severe injury.
9. Never tighten hardware completely at first. It helps to have some adjustment for bolt alignment while you are attaching parts together. After everything is square, tighten each joint.
10. After the main unit is assembled it is critical that the floor is level and square. If the main frame is not level, the walls and floor will be out of square.
11. After you complete installation, make sure every bolt, screw, and nut is tight, and every board is secure. Wood will expand and contract with the seasons. Check all bolt connections and swing hangers every two weeks.
12. Place the set on level ground, not less than 6ft from any structure or obstruction such as a fence, garage, house, overhanging branches, laundry lines, or electrical wires.

READ! VERY IMPORTANT!

If you are missing parts or have questions regarding the installation of our quality product PLEASE call us directly at our offices (1-888-363-4967). Our trained staff will be happy to assist you.

Customer service hours:

**Monday thru Friday 9am to 4pm
Eastern Standard Time.**

E-mail: custservice@creativecedardesigns.com

Suggested Playground Surfacing

- ❑ Playground equipment should never be placed on hard surfaces such as concrete or asphalt.
- ❑ Do not install loose fill surfacing over hard surfaces such as concrete or asphalt.
- ❑ Shredded bark mulch, wood chips, fine sand and fine gravel, are added as shock absorbing materials after assembly. If used properly these materials can absorb some of the impact of a child’s fall.
- ❑ All surface material should extend a minimum of 6 feet in all directions around the play area.
- ❑ Do not apply playground surfacing until after the unit is completely constructed. Playset should not be built on top of surfacing.
- ❑ Use containment, such as digging out around the perimeter and/or lining the perimeter with landscape edging.
- ❑ Installation of rubber tiles or poured-in-place surfaces (other than loose-fill materials) generally require a professional and are not “do-it-yourself” projects.
- ❑ Shall use Playground Surfacing Materials (other than loose-fill material) which comply to the safety standard ASTM F1292 Standard Specification of Impact Attenuation of Surfacing Materials within the Use Zone of Playground Equipment.

The following chart explains the fall height in feet from which a life threatening head injury would not be expected

Critical Heights in feet (m) of Tested Materials

Material	Uncompressed Depth			Compressed Depth
	6" (152mm)	9" (228mm)	12" (304mm)	to 9" (228mm)
Wood Chips	7' (2.13m)	10' (3.05m)	11' (3.35m)	10' (3.05m)
Double-Shredded bark mulch	6' (1.83m)	10' (3.05m)	11' (3.35m)	7' (2.13m)
Engineered Wood Fibers	6' (1.83m)	7' (2.13m)	>12' (3.66m)	6' (1.83m)
Fine Sand	5' (1.52m)	5' (1.52m)	9' (2.74m)	5' (1.52m)
Coarse Sand	5' (1.52m)	5' (1.52m)	6' (1.83m)	4' (1.22m)
Fine Gravel	5' (1.52m)	7' (2.13m)	10' (3.05m)	6' (1.83m)
Medium Gravel	5' (1.52m)	5' (1.52m)	6' (1.83m)	5' (1.52m)
Shredded Tires*	10-12' (3.0-3.6m)	N/A	N/A	N/A

*This data is from tests conducted by independent testing laboratories on a 6-inch depth of uncompressed shredded tire samples produced by four manufacturers. The tests reported critical heights, which varied from 10 feet to greater than 12 feet. It is recommended that persons seeking to install shredded tires as a protective surface request test data from the supplier showing the critical height of the material when it was tested in accordance with ASTM F1292.

Operating Instructions:



NOTE: Your children's safety is our #1 concern. Observing the following statements and warnings reduces the likelihood of serious or fatal injury. Please review these safety rules regularly with your children.

1. This Playcenter is designed for the use of 4 occupants not exceeding 290 pounds.
2. On-site adult supervision is **required**.
3. Instruct children **not** to walk close to, in front of, behind, or between moving swings or other moving playground equipment.
4. Instruct children to sit in and **never** stand on swings
5. Instruct children **not** to twist the chains and ropes and not to loop them over the top support bar, since this may reduce the strength of the chain or rope.
6. Instruct children **not** to jump from swings or other playground equipment in motion.
7. Instruct children to **not push** empty seats. The seat may hit them and cause serious injury.
8. Instruct and teach children to sit in the center of the swings with their full weight on the seats.
9. Instruct children **not** to use the equipment in a manner other than intended.
10. Instruct children to **always** go down slides feet first. Never slide headfirst.
11. Instruct children to **look** before they slide to make sure no one is at the bottom.
12. Instruct children to **never** run up a slide, as this increases their chances of falling.
13. The parents should have the children **dress appropriately** with well-fitting shoes. Loose clothing such as scarves and ponchos should not be worn. Always take off, tie up or tuck in cords and drawstrings on children's clothing. These things can get caught on playground equipment and strangle a child.
14. Instruct children **not** to climb when the equipment is wet.
15. Instruct children to **never** jump from a fort deck. They should always use the ladder, ramp or slide.
16. Instruct children to **never** crawl on top of a fort roof.
17. Verify that any suspended climbing ropes, chain, or cable are secured at both ends and that they cannot be looped back on it.
18. Instruct children **not** to attach items to the playground equipment that are not specifically designed for use with the equipment, such as, but not limited to, jump ropes, clothesline, pet leashes, cables, and chain as they may cause a strangulation hazard.
19. Instruct children to **never** wrap their legs around swing chain.
20. Instruct children to **never** slide down the swing chain.

Maintenance Instructions:

1. Check all nuts and bolts twice monthly during the usage season and tighten as required. (But not so tight that you crack the wood) We recommend you check the swing beam and hardware every two weeks due to wood expansion and contraction. It is particularly important that this procedure be followed at the beginning of each season.
2. Remove plastic swing seats and take indoors or do not use when the temperature drops below 32 °F.
3. Oil all metallic moving parts monthly during the usage period.
4. Check all coverings for bolts and sharp edges twice monthly during usage season to be certain they are in place. Replace when necessary. It is especially important to do this at the beginning of each new season.
5. Check swing seats, ropes, cables and chains monthly during usage season for evidence of deterioration. Replacement should be made of any swing seat that has developed cracks in the plastic seats or has exposed metal in the edges of the swing seat. If there are already exposed metal inserts on the edge of the seat, immediately remove the seats and chains to prevent serious injury. Ropes, cables and chains should be removed and replaced if excessive wear is found. Contact Creative Cedar Designs for replacement parts.
6. For rusted areas on metallic members such as monkey bars, hand supports, brackets, etc., sand and repaint, using a non lead-based paint meeting the requirements of Title 16 CRF Part 1303.
7. Inspect wood parts monthly. The grain of the wood sometimes will lift in the dry season causing splinters to appear. Light sanding may be necessary to maintain a safe playing environment. If you are treating your Playcenter with stain regularly, it will help prevent severe checking/splitting and other weather damage.
8. We have applied a waterborne transparent stain to your unit. This is done for color only. **Once or twice a year, depending on your climate conditions, you must apply some type of protection (sealant) to the wood of your unit.** Prior to the application of sealant, lightly sand any “rough” spots on your set. **Please note this is a requirement of your warranty.**
9. Creating and maintaining the Playcenter on a level location is very important. As your children play, your Playcenter will slowly dig its way into the soil, and it is very important that it settles evenly. Make sure the play set is level and true once each year or at the beginning of each play season.
10. Rake the surface periodically to prevent compaction and maintain appropriate depths.

Disposal Instructions:

When the Playcenter use is no longer desired, it should be disassembled and disposed of in such a way that no unreasonable hazards will exist at the time the unit is discarded.

APPENDIX A

Information on Playground Surfacing Materials:

The following information is from the *United States Consumer Product Safety Commission's Information Sheet for playground surfacing material*. Also see the following website for additional information: <https://www.cpsc.gov/PageFiles/122146/324.pdf>

X3. CONSUMER INFORMATION SHEET FOR PLAYGROUND SURFACING MATERIALS¹¹

X3.1 The U.S. Consumer Product Safety Commission (CPSC) estimates that about 100,000 playground equipment-related injuries resulting from falls to the ground surface are treated annually in U.S. hospital emergency rooms. Injuries involving this hazard pattern tend to be among the most serious of all playground injuries, and have the potential to be fatal, particularly when the injury is to the head. The surface under and around playground equipment can be a major factor in determining the injury-causing potential of a fall. It is self evident that a fall onto a shock-absorbing surface is less likely to cause a serious injury than a fall onto a hard surface. Playground equipment should never be placed on hard surfaces such as concrete or asphalt and while grass may appear to be acceptable it may quickly turn to hard packed earth in areas of high traffic. Shredded bark mulch, wood chips, fine sand or fine gravel are considered to be acceptable shock absorbing surfaces when installed and maintained at a sufficient depth under and around playground equipment.

X3.2 Table X3.1 lists the maximum height from which a child would not be expected to sustain a life-threatening head injury in a fall onto four different loose-fill surfacing materials if they are installed and maintained at depths of 6, 9, and 12 in. However, it should be recognized that all injuries due to falls cannot be prevented no matter what surfacing material is used.

X3.3 It is recommended that a shock absorbing material should extend a minimum of 6 ft in all directions from the perimeter of stationary equipment such as climbers and slides. However, because children may deliberately jump from a moving swing, the shock absorbing material should extend in the front and rear of a swing a minimum distance of 2 times the height of the pivot point measured from a point directly beneath the pivot on the supporting structure.

X3.4 This information is intended to assist in comparing the relative shock-absorbing properties of various materials. No particular material is recommended over another. However, each material is only effective when properly maintained. Materials should be checked periodically and replenished to maintain correct depth as determined necessary for your equipment. The choice of a material depends on the type and height of the playground equipment, the availability of the material in your area, and its cost.

¹¹This information has been extracted from the CPSC publications "Playground Surfacing — Technical Information Guide" and "Handbook for Public Playground Safety." Copies of these reports can be obtained by sending a postcard to: Office of Public Affairs, U.S. Consumer Product Safety Commission, Washington, D.C., 20207 or call the toll-free hotline: 1-800-638-2772.

The American Society for Testing and Materials takes no position respecting the validity of any patent right asserted in connection with any item mentioned in this standard. Users of this standard are expressly advised that determination of the validity of any such patent rights, and the risk of infringement of such rights, are entirely their own responsibility.

The standard is subject to revision at any time by the responsible technical committee and must be reviewed every five years and if not revised, either approved or withdrawn. Your comments are invited either for revision of this standard or for additional standards and should be addressed to ASTM Headquarters. Your comments will receive careful consideration at a meeting of the responsible technical committee, which you may attend. If you feel that your comments have not received a fair hearing you should make your views known to the ASTM Committee on Standards, 100 Barr Harbor Drive, West Conshohocken, PA 19428.

SKY VIEW GYM SET

Assembly Instructions

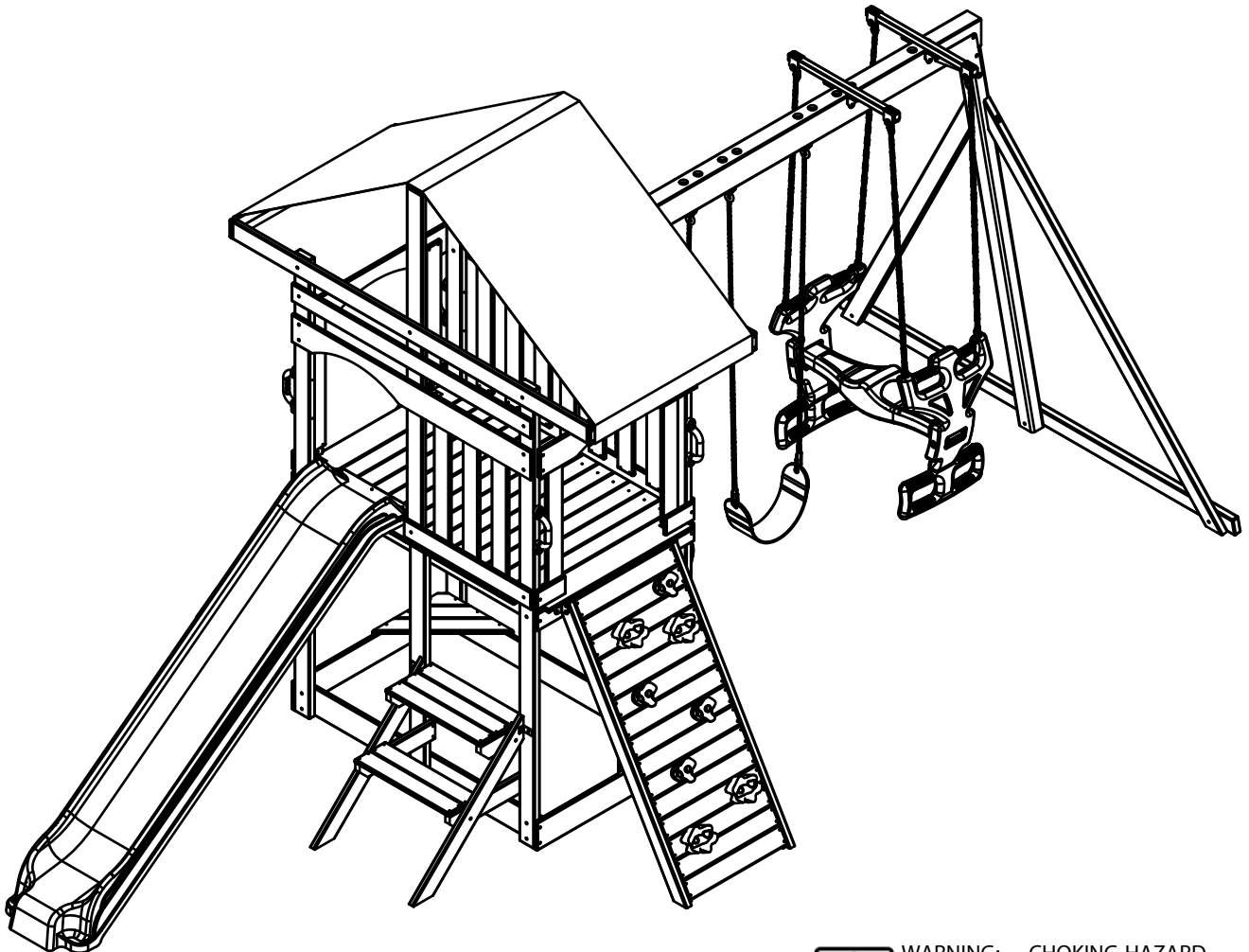

WARNING: CHOKING HAZARD
Unassembled parts may be a choking hazard to children 3 years and younger



CAUTION: Adult Assembly Required.
Hardware contains small pieces with sharp points. Keep parts out of the reach of children until assembled. Parts of this product can present dangers if improperly assembled.



CAUTION: The plastic bags that contain the hardware may present a choking hazard to small children. Please keep these bags and all plastic bags out of the reach of children. Do not allow children to play with them and dispose of them immediately when empty.

Basic Setup Dimensions

Place the set on level ground, not less than 6ft (1.83M) from any structure or obstruction such as a fence, garage, house, overhanging branches, laundry lines or electrical wires.

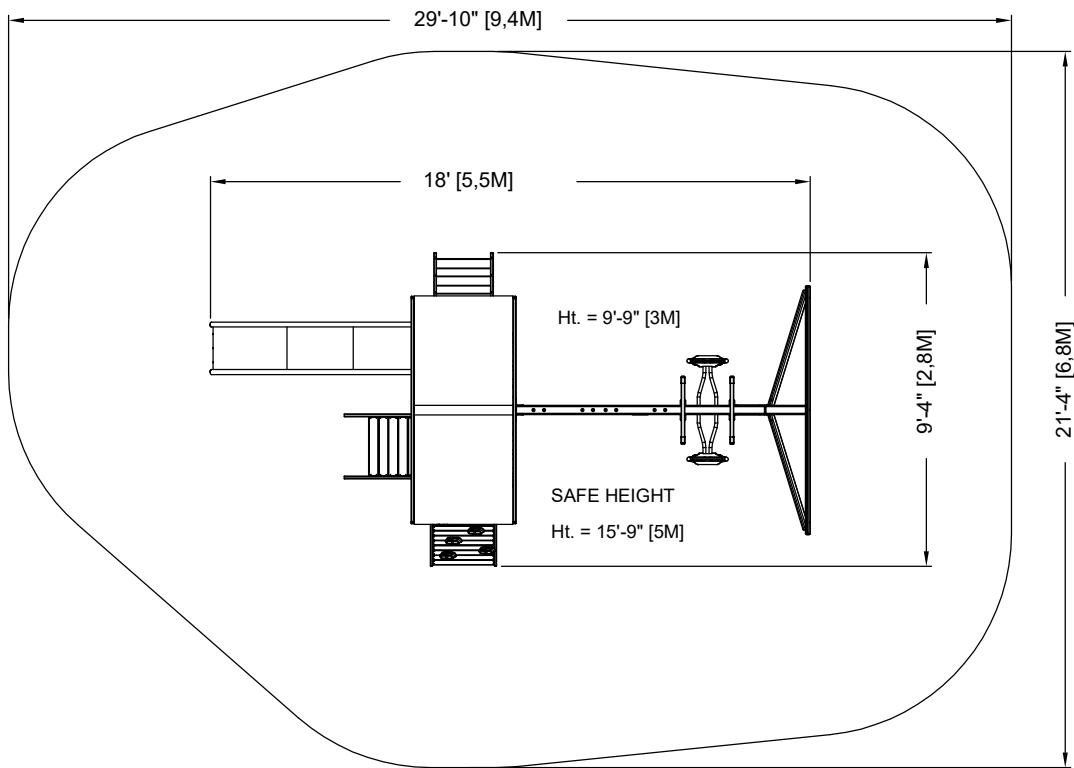

Important Assembly Notes

- 1) While assembling unit, take time before and after each phase to make sure Fort is level. If fort is not level, assembly will be difficult and improper assembly may result. Extra care must be taken to assure the fort is square on the phases that include this symbol in Fig i.
- 2) When installing a board on the small face of a 2x4, pre-drilling the attachment hole is **REQUIRED**. Just place the board where attachment is needed and by using the holes in the board as a guide, drill holes into the 2x4 with a $\frac{1}{8}$ " drill bit $1\frac{1}{4}$ " deep. Failure to Pre-drill may result in board splitting

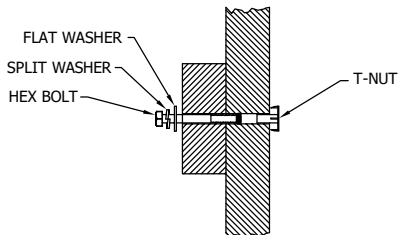
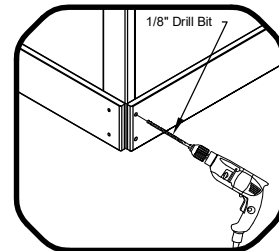
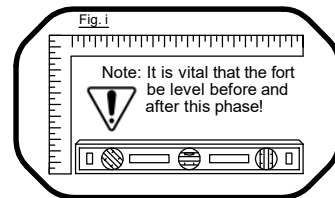

- 3) Whenever a T-nut is used, follow these directions. Place t-nut in pre-drilled hole. Tap in with hammer. Place bolt with split and flat washers in the] opposite side. Hand tighten to make sure the bolt is in the t-nut. Secure with socket. **DO NOT** Over Tighten.

- 4) Pay close attention to the "Items needed" and "Hardware needed" sections of each phase. They can be a valuable aid when sorting your wood and hardware. Assembly will be made easier if items are sorted by phase.
- 5) Pay close attention to make sure you are using the correct hardware in the correct places. Using incorrect hardware may result in improper assembly.
- 6) Read the steps of each phase thoroughly. The written steps may include important information not shown in the illustrations.

Parts Identification

Wood Components

(1) 3 5/16 X 5 5/16 X 89 1/2 SWING BEAM - LA251

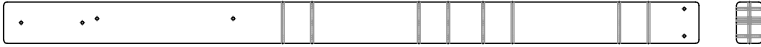

(1) 3 5/16 X 2 11/16 X 83 SWING END BEAM - LD254

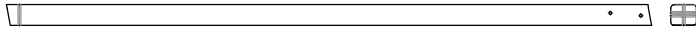

(2) 1 3/8 X 3 5/16 X 82 1/2 SWING ANGLE BRACE - LG252

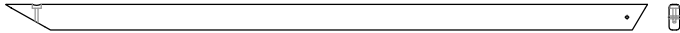

(1) 1 3/8 X 3 5/16 X 89 SWING GROUND BOARD - LG253

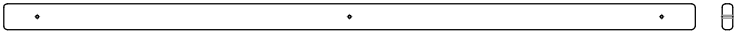

(2) 11/16 X 3 1/2 X 35 1/2 FLOOR SUPPORT - WA001-10

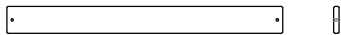

(10) 11/16 X 3 1/2 X 37 1/2 FLOOR BOARD - WA002-10

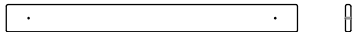

(2) 11/16 X 3 1/2 X 37 1/2 TARP SUPPORT - WA003-10

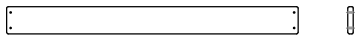

(1) 11/16 X 3 1/2 X 35 1/2 TARP SUPPORT - WA004-10



(1) 11/16 X 3 1/2 X 54 FLOOR BRACE - WA005-10

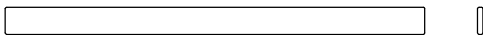

(3) 11/16 X 3 1/2 X 54 WALL RAIL - WA006-10



(1) 11/16 X 3 1/2 X 28 3/4 WALL RAIL - WA007-10

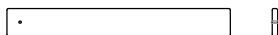

(4) 11/16 X 3 1/2 X 6 1/2 WALL RAIL - WA008-10



(13) 11/16 X 3 1/2 X 27 WALL SLAT - WA009-10

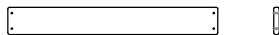

(5) 11/16 X 3 1/2 X 22 ROCKWALL ROCK BRD. - WA010-10



(3) 11/16 X 3 1/2 X 22 ROCKWALL ROCK BRD. - WA011-10

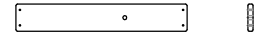

(7) 11/16 X 3 1/2 X 22 ROCKWALL SLAT - WA012-10

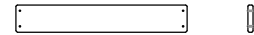

(6) 11/16 X 3 1/2 X 21 1/4 SAFETY / TABLE SLAT - WA014-10

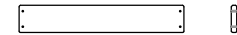

(2) 11/16 X 3 1/2 X 8 1/2 SANDBOX SEAT - WA015-10

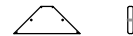

(2) 11/16 X 3 1/2 X 15 1/2 SANDBOX SEAT - WA016-10

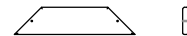

(2) 11/16 X 3 1/2 X 22 1/2 SANDBOX SEAT - WA017-10

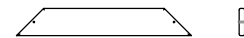

(3) 11/16 X 5 1/2 X 54 RAIL/GROUND BOARD - WB001-10

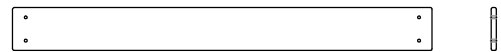

(1) 11/16 X 5 1/2 X 54 SIDE ARCH RAIL - WB002-10



(2) 11/16 X 5 1/2 X 35 1/2 GROUND BOARD - WB003-10

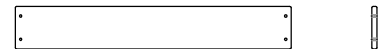

(2) 11/16 X 5 1/2 X 35 1/2 CENTER ARCH RAIL - WB004-10

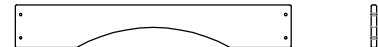

(2) 11/16 X 5 1/2 X 32 3/4 END FLOOR BRD. - WB005-10



(2) 1 X 3 1/2 X 54 FLOOR BRD. - WC001-10



(2) 1 X 3 1/2 X 80 TARP CROSS BRACE - WC002-10



(2) 1 X 3 1/2 X 69 TARP UPRIGHT - WC003-10

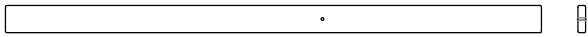

(1) 1 X 3 1/2 X 54 3/8 LADDER RAIL-LEFT - WC004-10

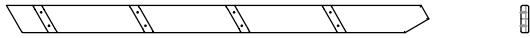

(1) 1 X 3 1/2 X 54 3/8 LADDER RAIL-RIGHT - WC005-10

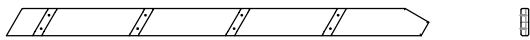

(4) 1 X 3 1/2 X 20 LADDER STEP - WC006-10

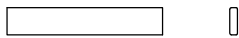

(2) 1 X 3 1/2 X 35 TABLE LEG - WC007-10

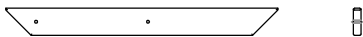

(2) 1 X 3 1/2 X 17 TABLE BRACE - WC008-10

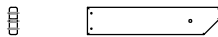

(2) 1 X 3 1/2 X 10 TABLE BRACE - WC009-10

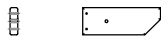

(1) 1 X 5 1/2 X 54 SWING BEAM CROSS BRACE - WD001-10

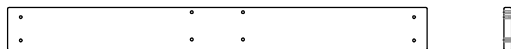

(4) 1 3/8 X 3 3/8 X 89 1/2 FORT UPRIGHT - WE001-10

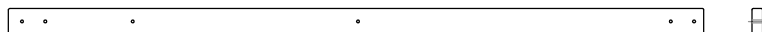

(1) 1 3/8 X 3 3/8 X 46 1/4 TABLE UPRIGHT - WE002-10

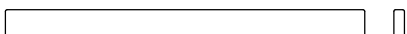

(1) 2 X 2 11/16 X 54 ROCKWALL RAIL-RIGHT - WSF001-10

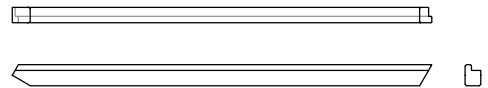

(1) 2 X 2 11/16 X 54 ROCKWALL RAIL-LEFT - WSF002-10

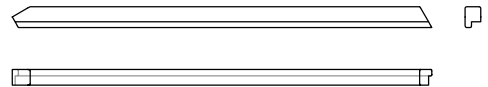

(2) 1 X 3 1/2 X 54 SLIDE FLOOR BRD- WA201

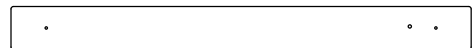

(1) 11/16 X 3 1/2 X 54 SLIDE FLOOR BRD- WA202



(1) 11/16 X 3 1/2 X 22 SLIDE SUPPORT- WM248

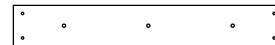

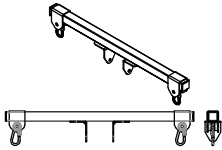

(2) GLIDER BRACKET
BP020
w/ HARDWARE

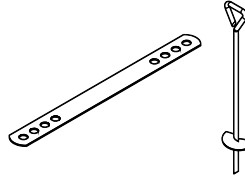

(4) ANCHOR PACK w/ HDW
BP001-B



(1) ID-TAG w/ HDW



(13) GREEN L-BRACKET (SMALL) - M002



(2) 4 COUNT BAGS CLIMBING ROCKS
BP011-GYBR
w/ HARDWARE



(2) GREEN ANGLE BRACKET (5") - M005

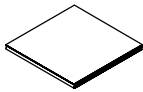

(1) FORT TARP (GREEN)
PT018
111" x 35-1/2"
w/ HARDWARE

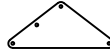

(2) 100° TRIANGLE PLATE - M100

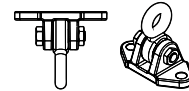

(4) SWING HANGER w/ HDW
KC 003

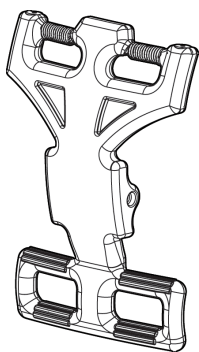

(2) GLIDER ARM

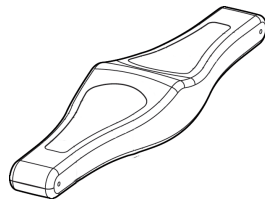

(1) GLIDER SEAT



(4) CHAIN w/ EYE BOLT

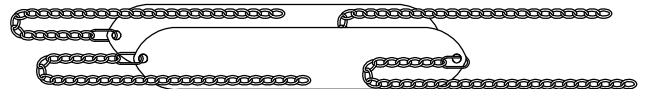

(2) STANDARD SWING SEAT
BP010-Y

(1) GLIDER - BP 018-GY
w/ HARDWARE

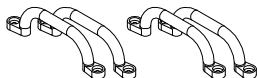

(2 PAIR) SAFETY HANDLE
BP007-Y
w/ HARDWARE



8' SLIDE (GREEN)

Hardware Identification

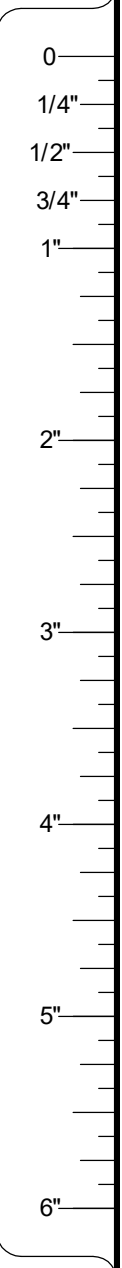
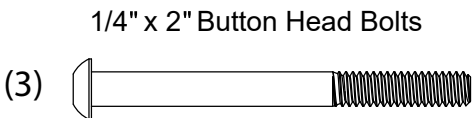
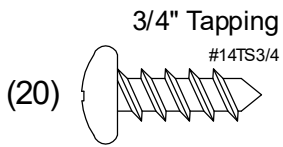
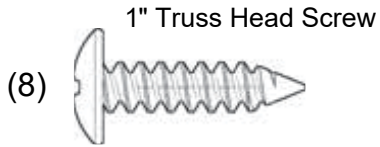
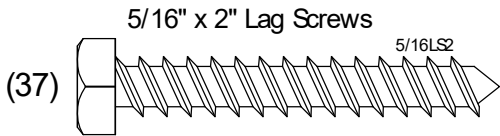
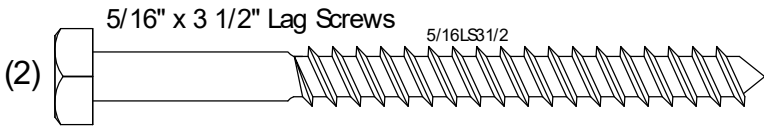
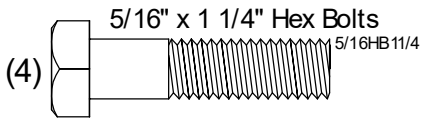
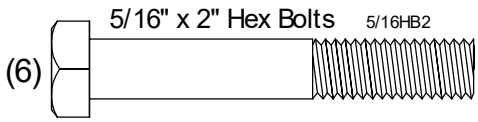
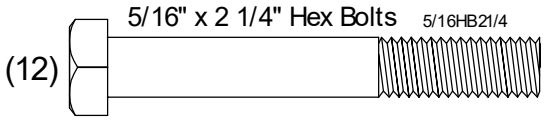
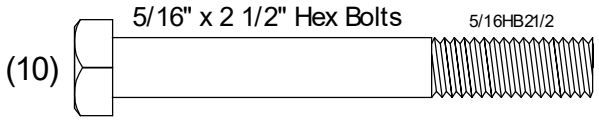
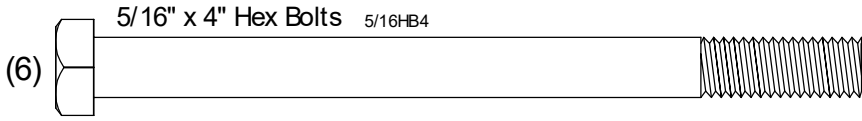

Hardware Identification

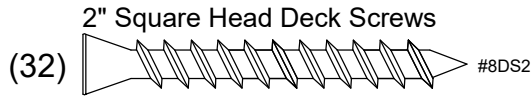
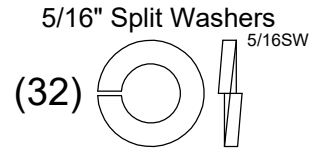

Fender Washer

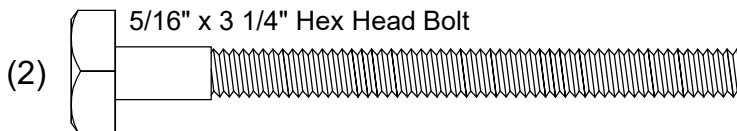
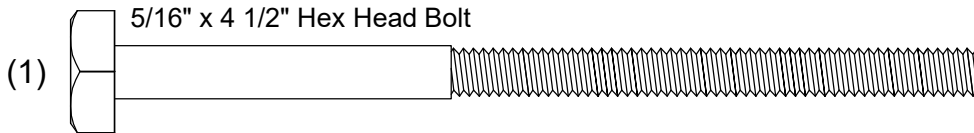
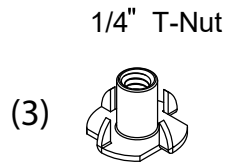
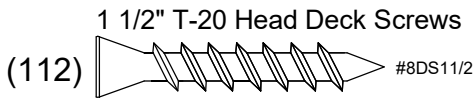
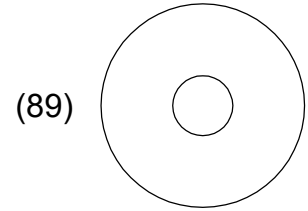
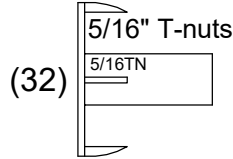

Measuring hardware

It is very important that you get the right hardware in the correct place when assembling the unit. You can compare the hardware to the hardware identification page.

NOTES:

- 1) Do not include bolt head when measuring length of bolt.
- 2) Include full length of deck screw when measuring.

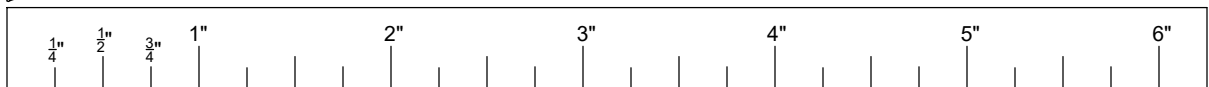
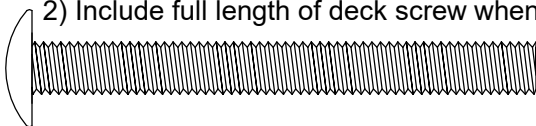

Phase 1: FORT FRAME ASSEMBLY

BUILD 2 FRAME ASSEMBLIES

Phase Hardware

(8) 5/16" x 2 1/4" Hex Bolts	5/16" Split Washers (12)	Fender Washer (12)
(4) 5/16" x 2 1/2" Hex Bolts		5/16" T-nuts (12)

Phase Parts

(2) 1 1/16 X 5 1/2 X 54 GROUND BOARD - WB001-10

(2) 1 X 3 1/2 X 54 FLOOR BRD. - WC001-10

(4) 1 3/8 X 3 3/8 X 89 1/2 FORT UPRIGHT - WE001-10

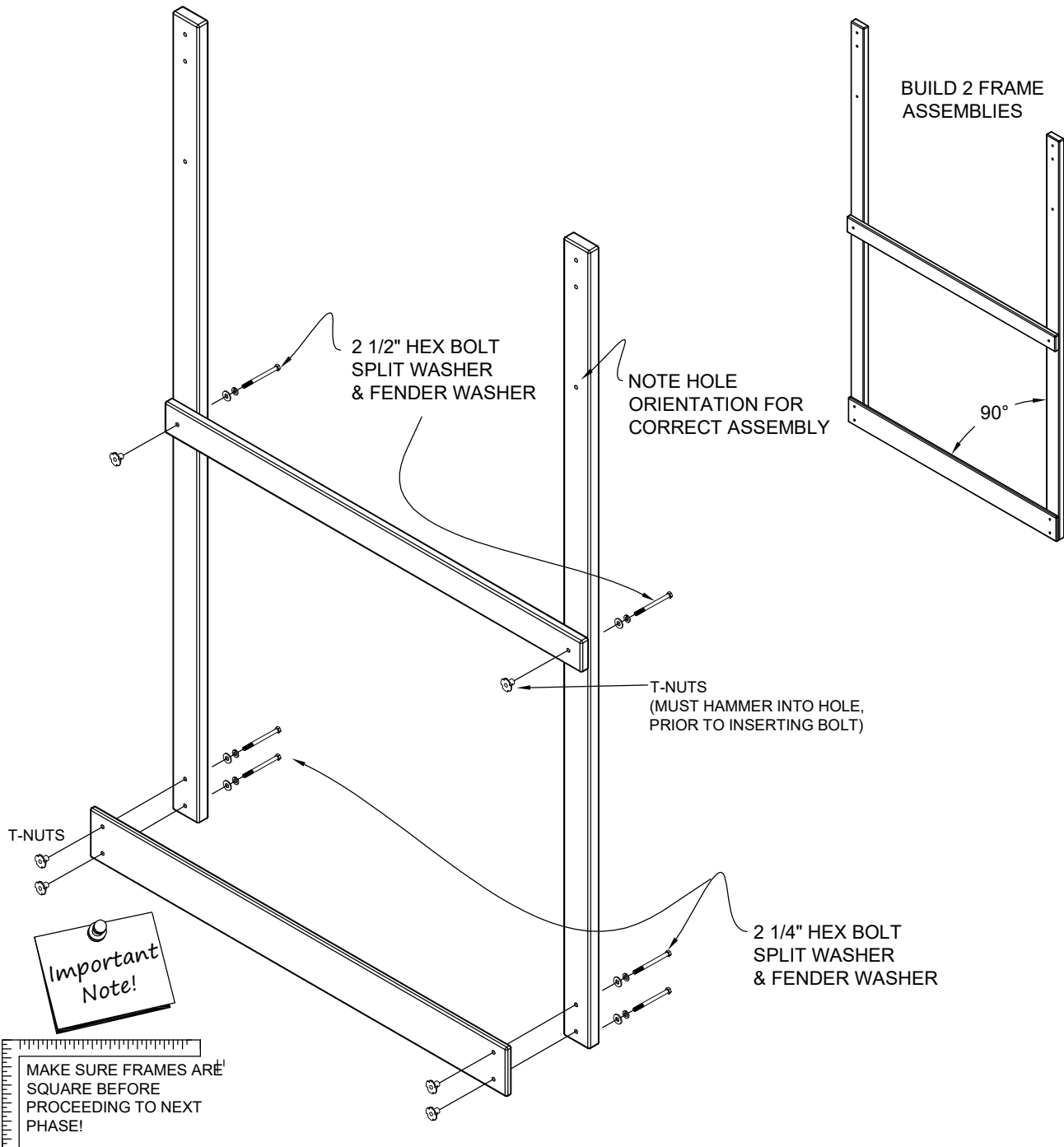

Phase 2: FORT FRAME ASSEMBLY

Phase Hardware



Phase Parts

(2) 11/16 X 3 1/2 X 35 1/2 FLOOR SUPPORT - WA001-10



(2) 11/16 X 5 1/2 X 35 1/2 GROUND BOARD - WB003-10

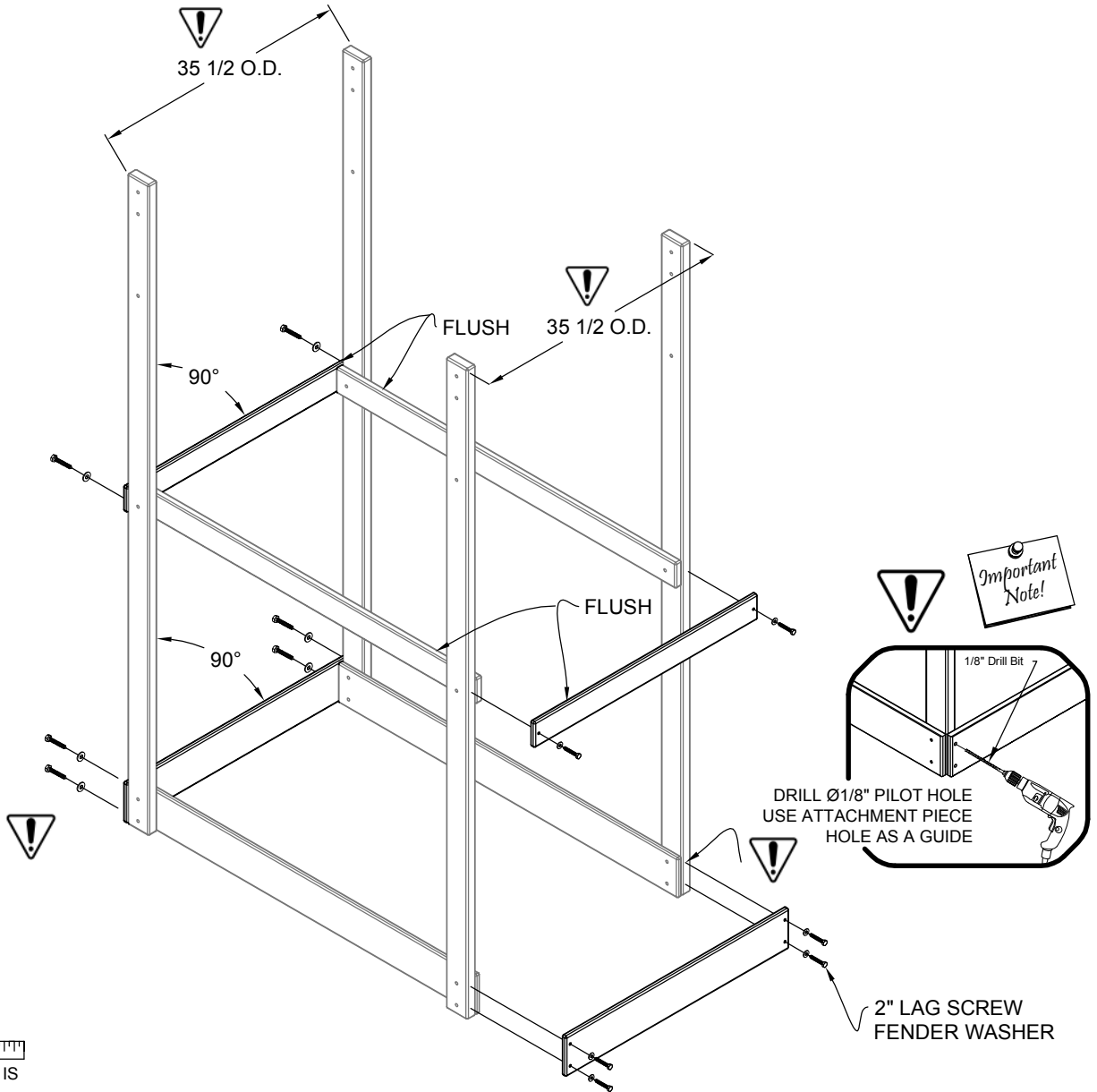
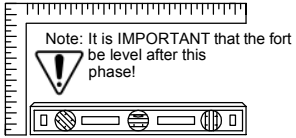

Important Note!

Important Note!

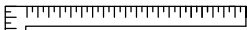

MAKE SURE FRAME IS SQUARE BEFORE PROCEEDING TO NEXT PHASE!

Phase 3: FLOOR INSTALLATION

Phase Hardware

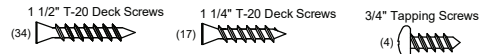

Phase Parts

- (10) 11/16 X 3 1/2 X 37 1/2 FLOOR BOARD - WA002-10
- (2) 11/16 X 5 1/2 X 32 3/4 END FLOOR BRD. - WB005-10
- (2) GREEN L-BRACKET (SMALL) - M002
- (1) 11/16 X 3 1/2 X 54 FLOOR BRACE - WA005-10
- (2) 11/16 X 3 1/2 X 37 1/2 FLOOR BOARD - WA201
- (1) 11/16 X 3 1/2 X 37 1/2 FLOOR BOARD - WA202

SCREW INTO FLOOR JOIST

Important Note!

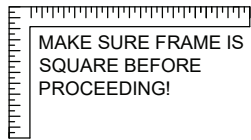

WB005-10

CENTER FLOOR LAYOUT

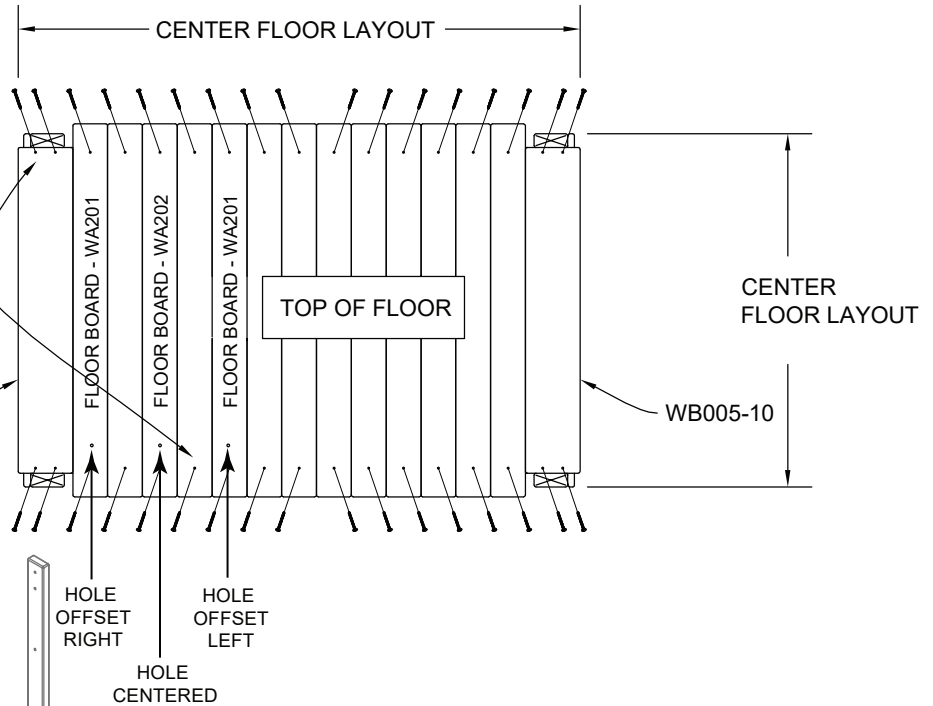

Important Note!

HAND TIGHTEN ALL TAPPING SCREWS

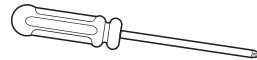

WA005-10 CENTERED & FLAT AGAINST THE BOTTOM OF FLOOR

1 1/4" DESK SCREWS (2 SCREWS INTO EACH END FLOOR BOARD. 1 SCREW INTO ALL OTHER FLOOR BOARDS)

(2) 3/4" TAPPING SCREW IN EACH BRACKET

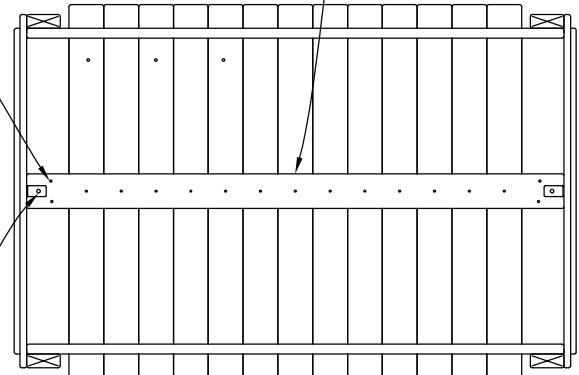
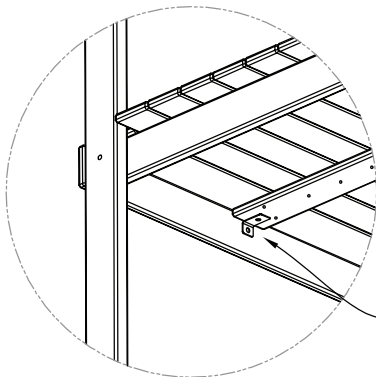

BOTTOM OF FLOOR

Phase 4: RAIL ATTACHMENT



USE A STEP LADDER FOR SAFETY!

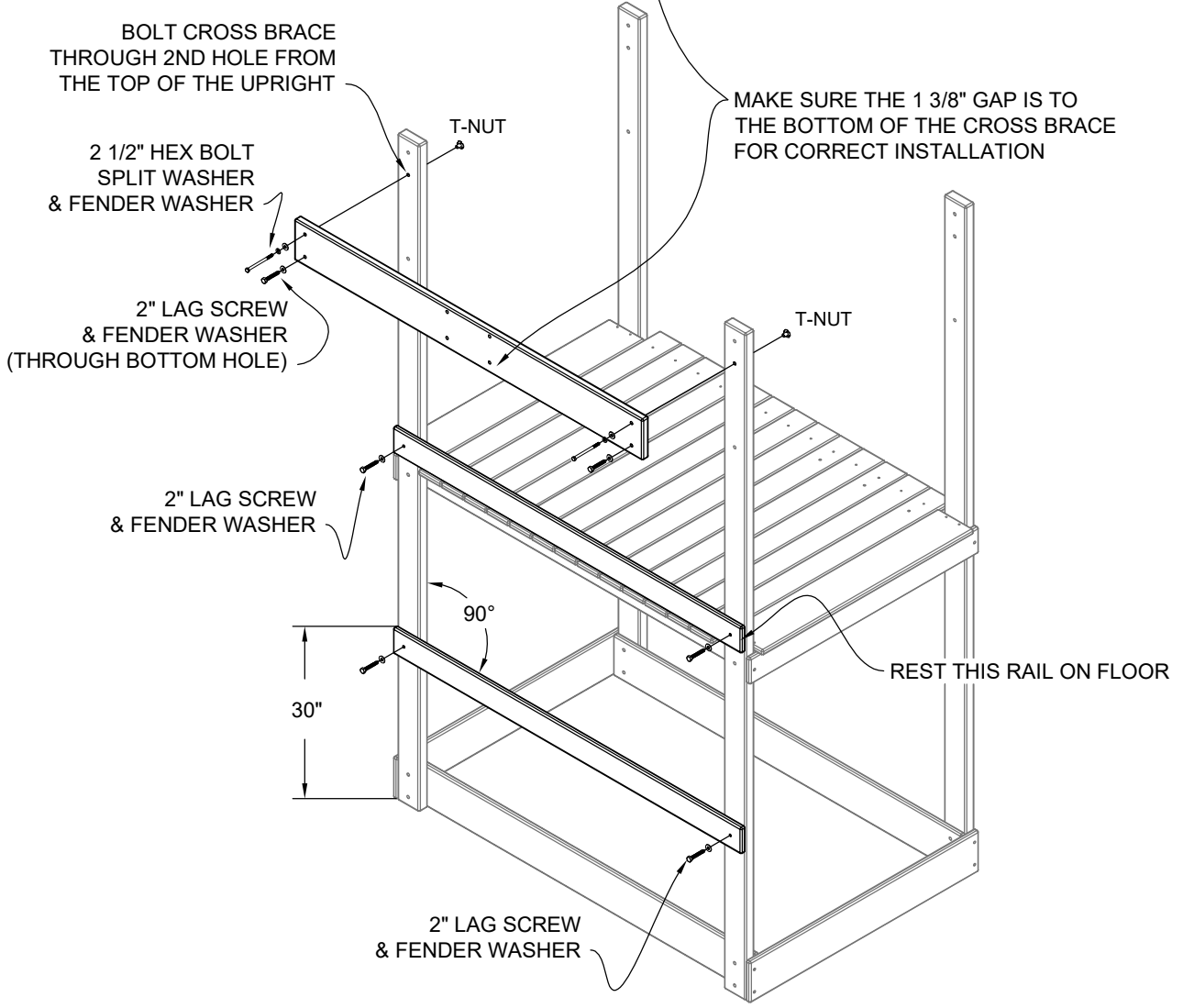
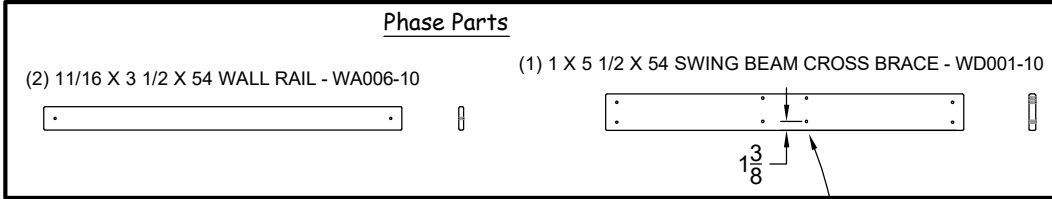
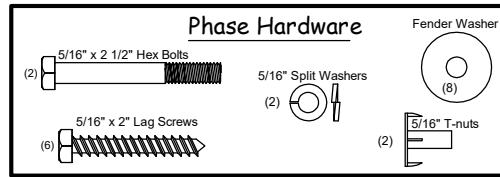

Phase 5:

DECK LADDER ASSEMBLY

Phase Hardware

(16) 2 1/2" Square Head Deck Screws

(4) 2" Square Head Deck Screws

Phase Parts

(1) 1 X 3 1/2 X 54 3/8 LADDER RAIL-LEFT - WC004-10

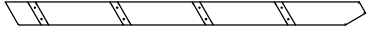

(4) 1 X 3 1/2 X 20 LADDER STEP - WC006-10

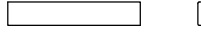

(1) 1 X 3 1/2 X 54 3/8 LADDER RAIL-RIGHT - WC005-10

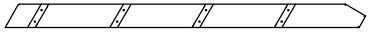

(1) 11/16 X 3 1/2 X 21 1/4 SAFETY / TABLE SLAT - WA014-10

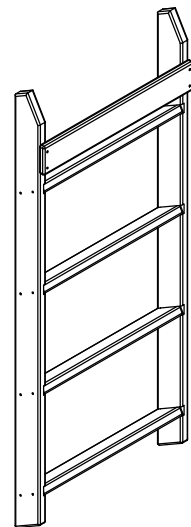
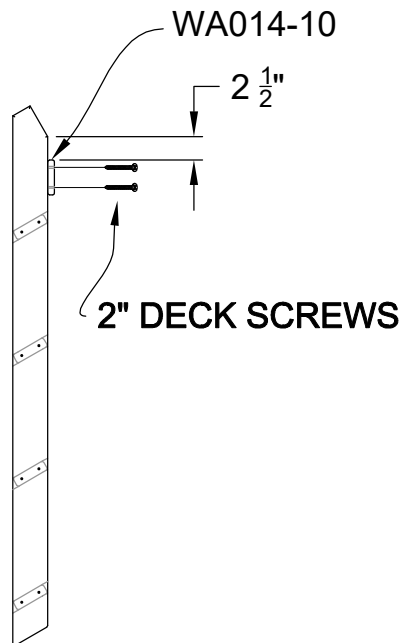
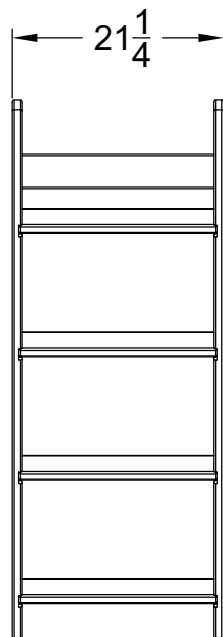
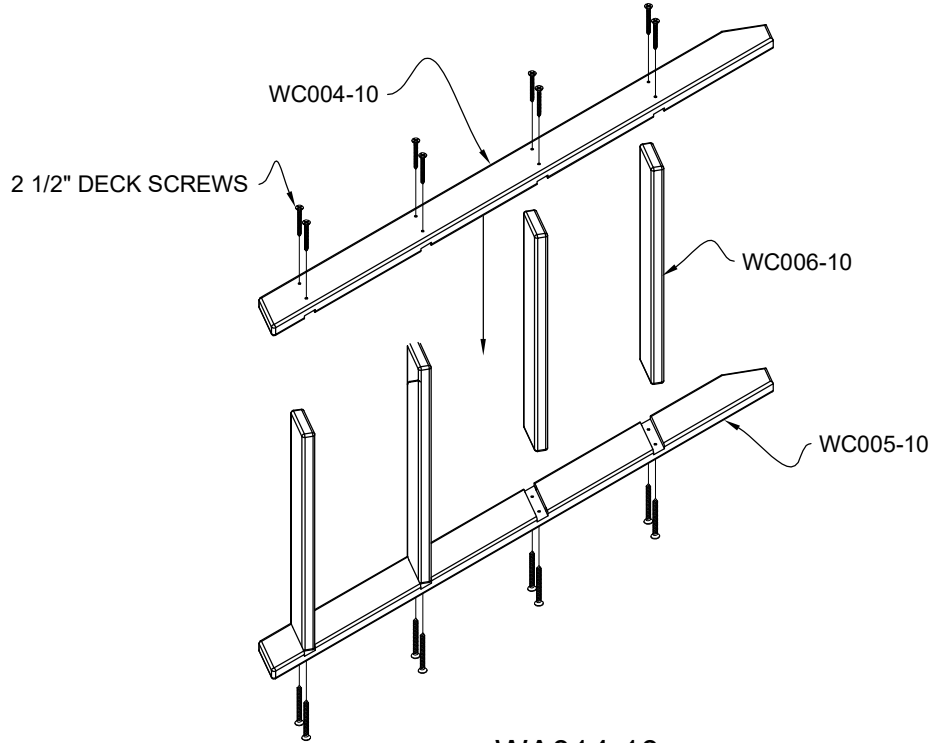
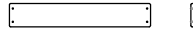

Phase 6: ROCKWALL ASSEMBLY

Phase Hardware

1 1/2" T-20 Deck Screws
(60)

PLEASE REFER TO
ACCESSORY PLAN FOR
INSTALLATION INSTRUCTIONS
AND HARDWARE.

Phase Parts

(5) 11/16 X 3 1/2 X 22 ROCKWALL ROCK BRD. - WA010-10

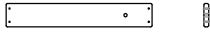

(3) 11/16 X 3 1/2 X 22 ROCKWALL ROCK BRD. - WA011-10

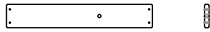

(7) 11/16 X 3 1/2 X 22 ROCKWALL SLAT - WA012-10

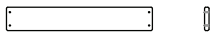

(2) 4 COUNT BAGS CLIMBING ROCKS
BP011-GYBR



(1) 2 X 2 11/16 X 54 ROCKWALL RAIL-RIGHT - WSF001-10

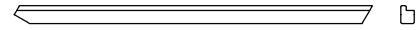

(1) 2 X 2 11/16 X 54 ROCKWALL RAIL-LEFT - WSF002-10

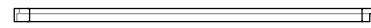
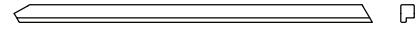

START FIRST BOARD
'WA012-10' FLUSH WITH
ANGLED EDGE

TOP END

1 1/2" DECK SCREW

1 1/2" DECK SCREW

WSF002-10

WSF001-10

PUSH ALL BOARDS TO TOP BOARD
(NO GAPS)

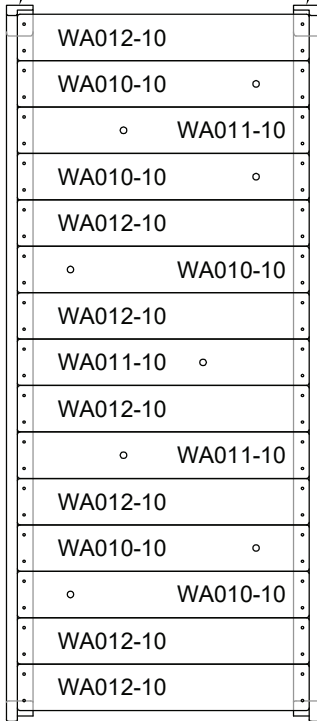

23 5/8" O.D.

ASSEMBLED
END VIEW

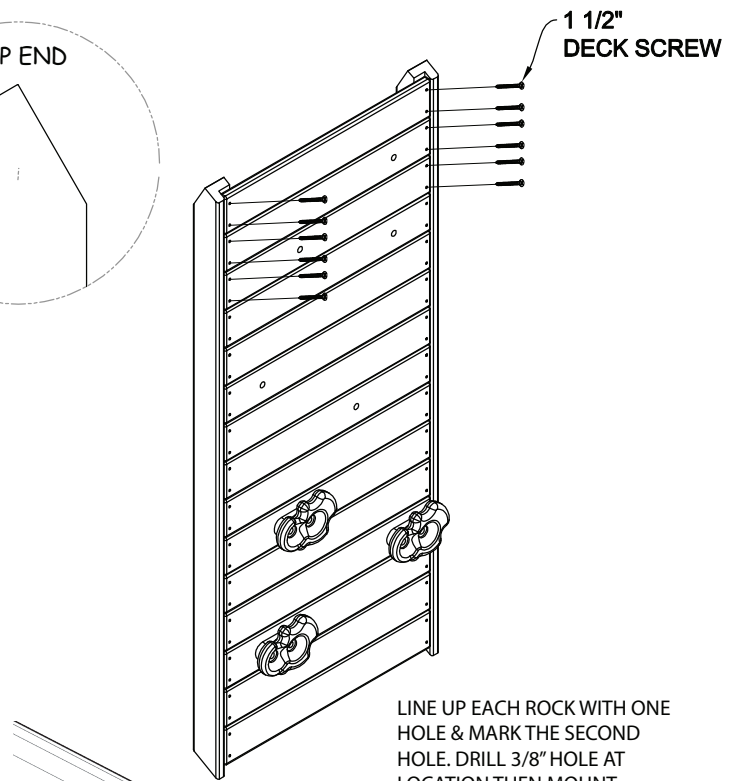

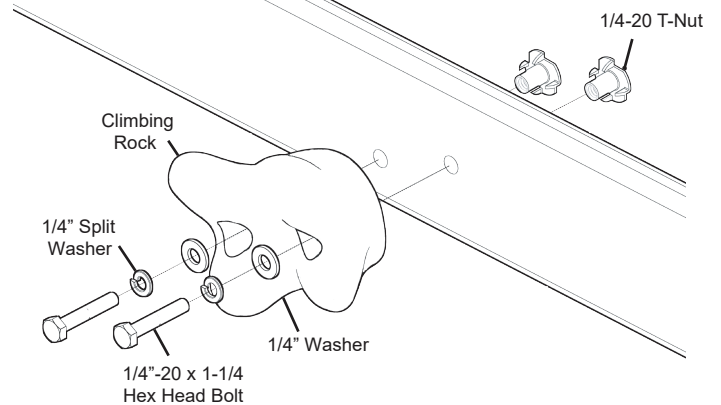

LINE UP EACH ROCK WITH ONE
HOLE & MARK THE SECOND
HOLE. DRILL 3/8" HOLE AT
LOCATION THEN MOUNT
AS SHOWN BELOW.

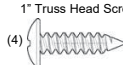

Phase 7: **ROCKWALL & LADDER ATTACHMENT**

Phase Hardware

1" Truss Head Screw (4)  3/4" Tapping Screws (4) 

Phase Parts



(4) GREEN L-BRACKET (SMALL) - M002

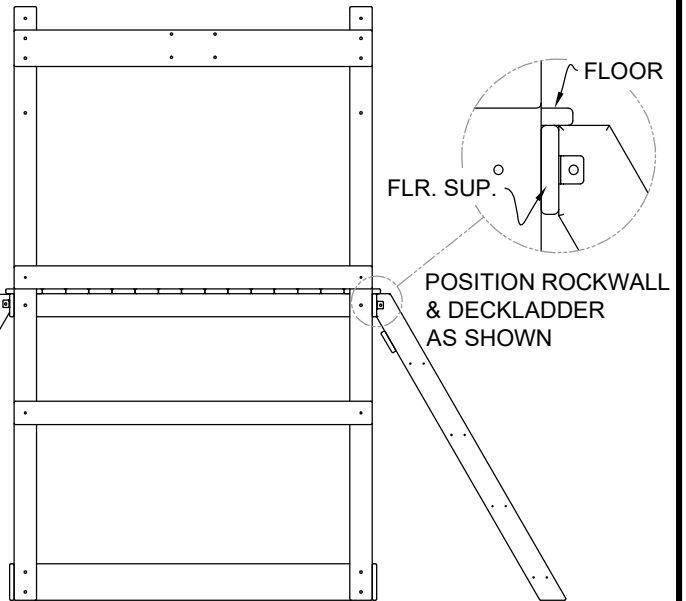
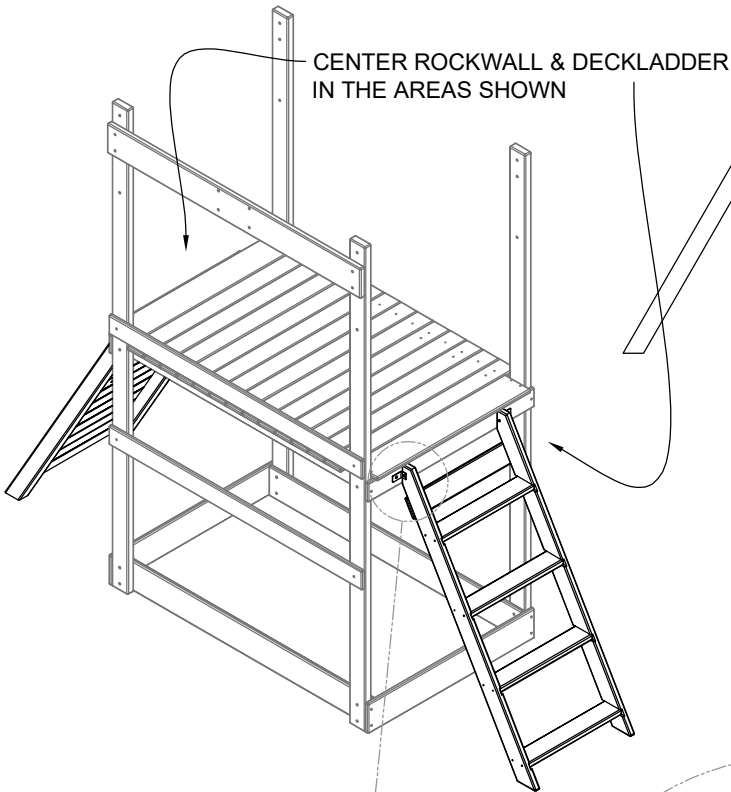

Important Note!

DO NOT OVER TIGHTEN TAPPING SCREWS!

Important Note!

HAND TIGHTEN ALL TAPPING SCREWS

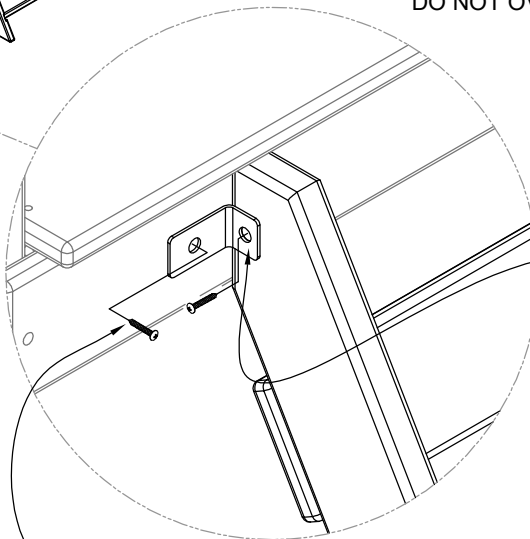

1" TRUSS HEAD SCREW THROUGH BRACKET INTO RAIL

3/4" #14 TAPPING SCREW THROUGH BRACKET INTO FLOOR SUPPORT

Important Note!

ATTACH ROCKWALL IN LIKE MANNER

Phase 8:

TOP RAIL
INSTALLATION

Phase Hardware

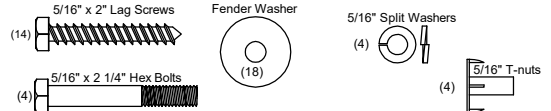

Phase Parts

(1) 11/16 X 5 1/2 X 54 RAIL/GROUND BOARD - WB001-10



(2) 11/16 X 5 1/2 X 35 1/2 CENTER ARCH RAIL - WB004-10

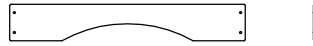

(1) 11/16 X 5 1/2 X 54 SIDE ARCH RAIL - WB002-10

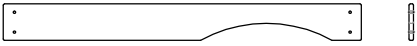

(1) 11/16 X 3 1/2 X 54 WALL RAIL - WA006-10

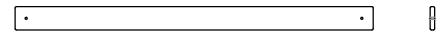

TOP WALL RAILS ARE FLUSH WITH EACH OTHER

2" LAG SCREW & FENDER WASHER THROUGH THE TOP HOLE OF RAIL (INSTALL BOLT IN BOTTOM HOLE OF RAIL FIRST) WB001-10

2 1/4" HEX BOLT SPLIT WASHER & FENDER WASHER

WB001-10 (ATTACH THIS RAIL FIRST, THEN ALIGN THE OTHER RAILS FLUSH WITH IT'S TOP EDGE)

35 1/2 O.D.

T-NUTS

WB002-10

WA006-10

* 2 1/2" BETWEEN BOARDS





WA006-10

* 2 1/2"

Phase 9:

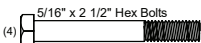
TARP BRACE INSTALLATION

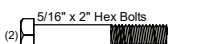
Phase Hardware

(4)  5/16" x 2 1/2" Hex Bolts	(6)  5/16" Split Washers	 Fender Washer (6)
(2)  5/16" x 2" Hex Bolts	(2)  1 1/2" T-20 Deck Screws	(6)  5/16" T-nuts

Phase Parts

(2) 1 X 3 1/2 X 80 TARP CROSS BRACE - WC002-10

(2) 1 X 3 1/2 X 69 TARP UPRIGHT - WC003-10

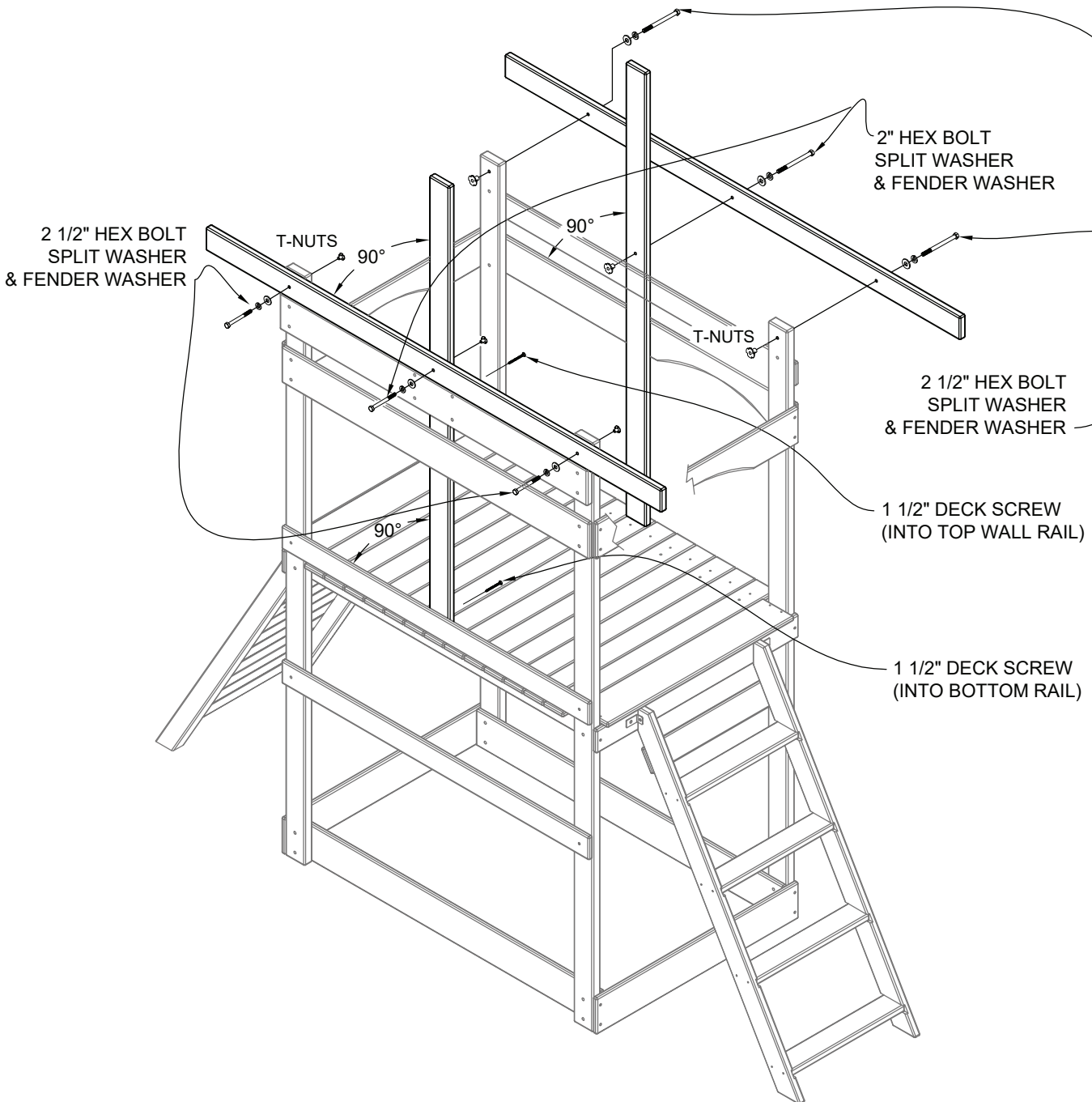
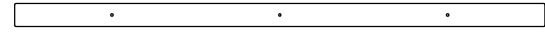

Phase 10:

LOWER RAIL ATTACHMENT

Phase Hardware



Phase Parts

(1) 1 1/16 X 3 1/2 X 28 3/4 WALL RAIL - WA007-10

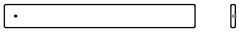

(2) 1 1/16 X 3 1/2 X 8 1/2 SANDBOX SEAT - WA015-10



(2) 1 1/16 X 3 1/2 X 15 1/2 SANDBOX SEAT - WA016-10

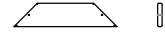

(2) 1 1/16 X 3 1/2 X 22 1/2 SANDBOX SEAT - WA017-10

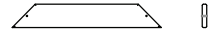

(4) 1 1/16 X 3 1/2 X 6 1/2 WALL RAIL - WA008-10

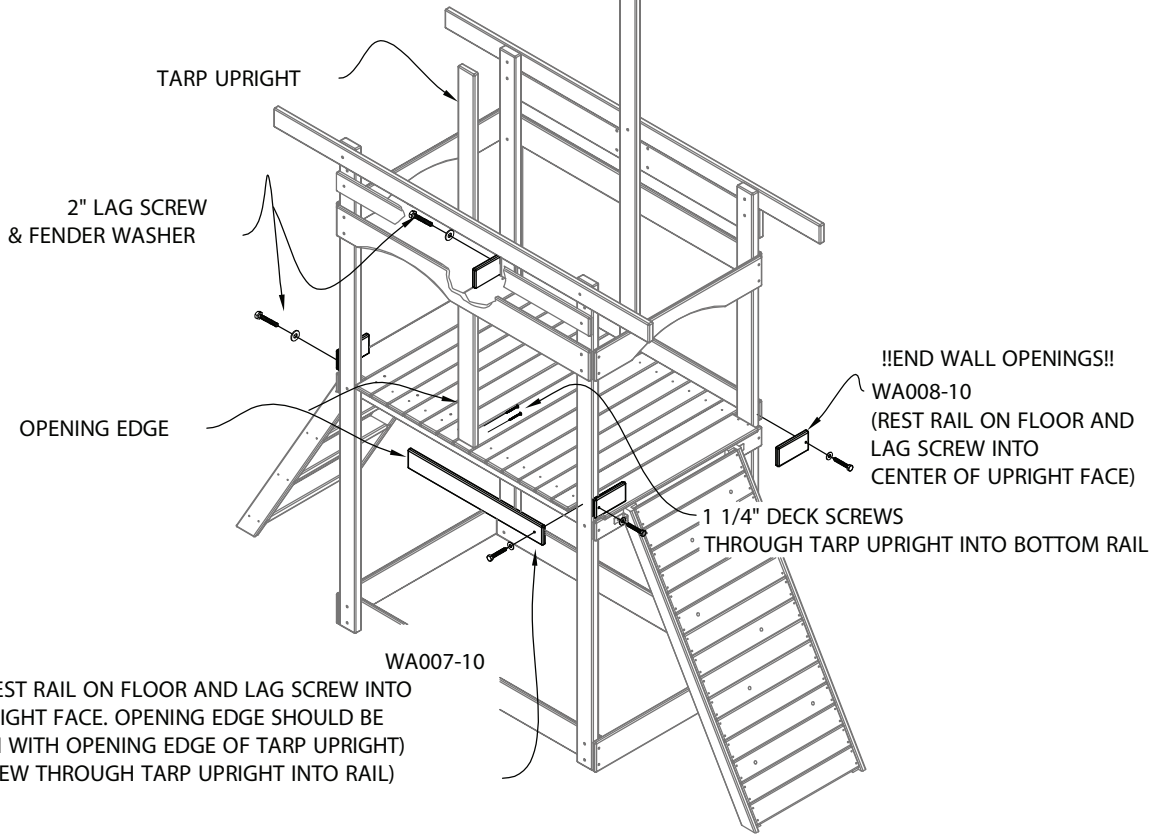

Phase 10-B:

SANDBOX SEAT INSTALLATION

1 1/4" DECK SCREWS

ARRANGE SEAT BOARDS AS SHOWN
ATTACH WITH DECK SCREWS INTO CENTER OF TOP EDGE
OF GROUND BOARDS

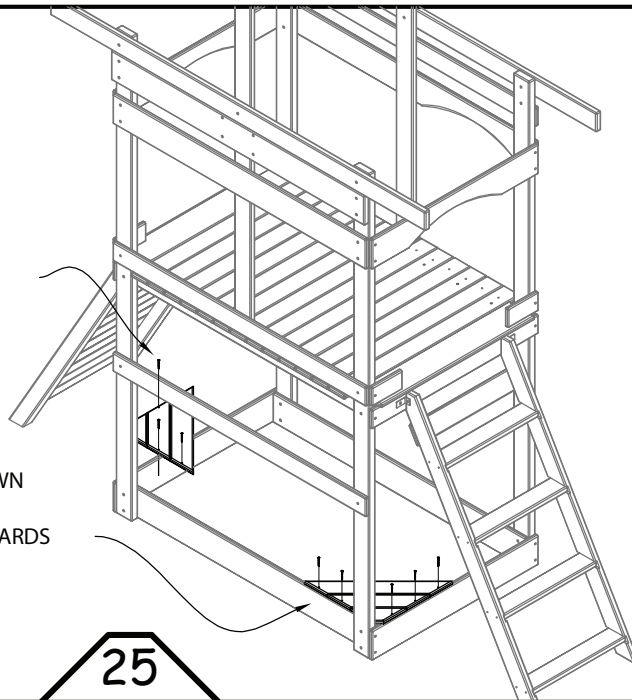

Phase 11:

WALL SLAT ATTACHMENT

Phase Hardware

1 1/4" T-20 Deck Screws
(52)

3/4" Tapping Screws
(10)

Phase Parts

(13) 11/16 X 3 1/2 X 27 WALL SLAT - WA009-10



(5) GREEN L-BRACKET (SMALL) - M002

Important Note!

PRE-DRILL CONNECTIONS WITH A 1/8" BIT TO PREVENT SPLITTING BOARDS.

FLOOR

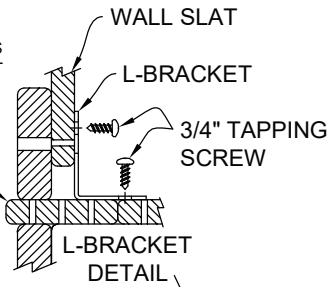

L-BRACKET
L-BRACKET
DETAIL

Important Note!

HAND TIGHTEN ALL TAPPING SCREWS

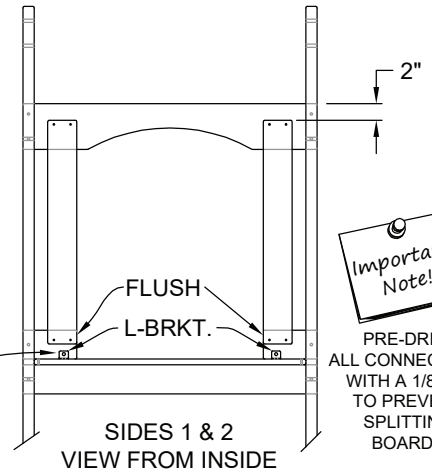
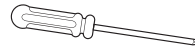

SIDES 1 & 2
VIEW FROM INSIDE

Important Note!

PRE-DRILL ALL CONNECTIONS WITH A 1/8" BIT TO PREVENT SPLITTING BOARDS.

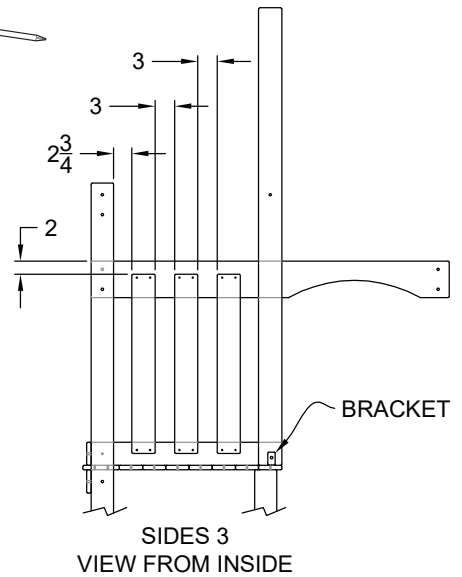
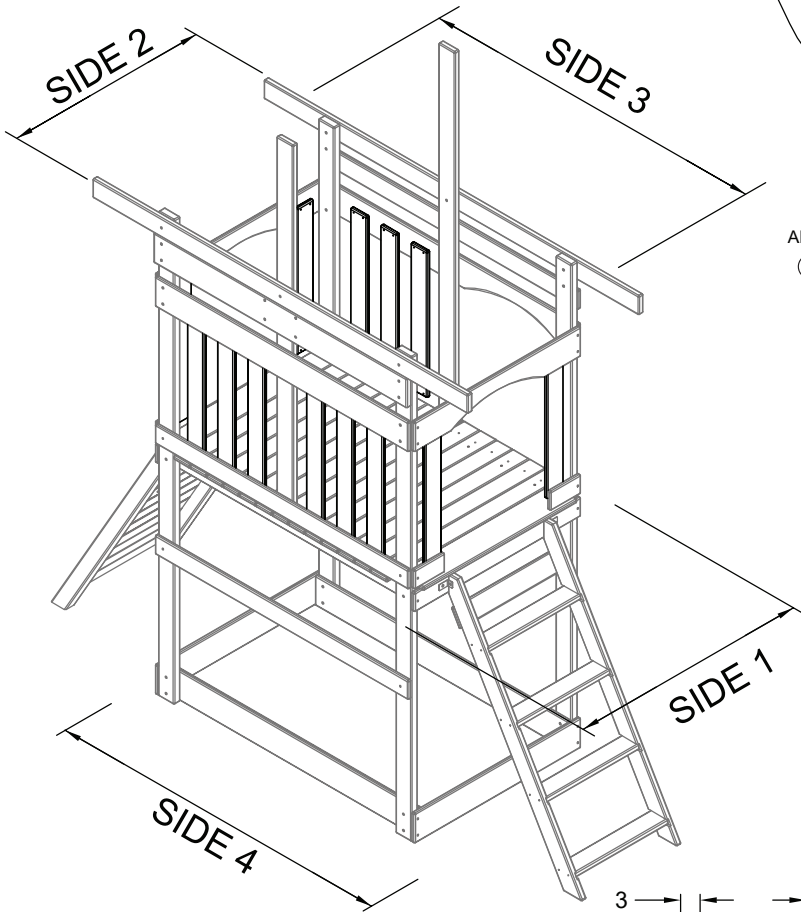

SIDES 3
VIEW FROM INSIDE

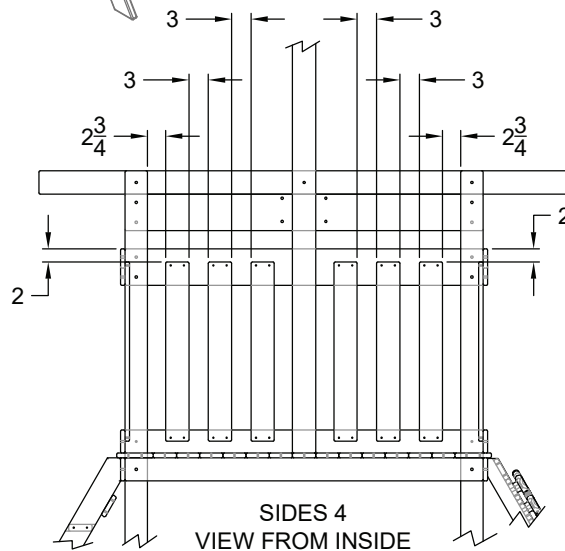

SIDES 4
VIEW FROM INSIDE

Phase 12:

TARP SUPPORTS
LUNCH TABLE UPRIGHT

Phase Hardware

1 1/2" T-20 Deck Screws
(16) 

Phase Parts

(2) 1 1/16 X 3 1/2 X 37 1/2 TARP SUPPORT - WA003-10



(1) 1 3/8 X 3 3/8 X 46 1/4 TABLE UPRIGHT - WE002-10

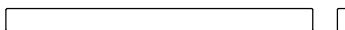

(1) 1 1/16 X 3 1/2 X 35 1/2 TARP SUPPORT - WA004-10



DECK SCREWS

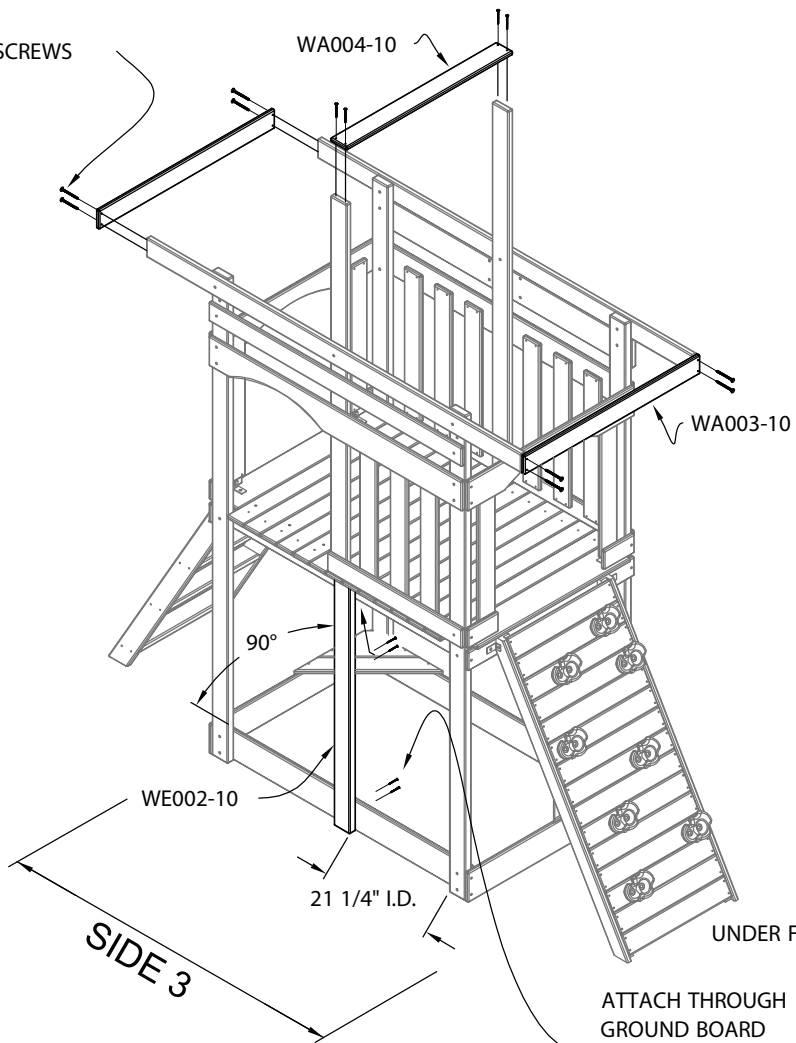

FIT
UNDER FLOOR

ATTACH THROUGH
GROUND BOARD
INTO 'WE002-10'

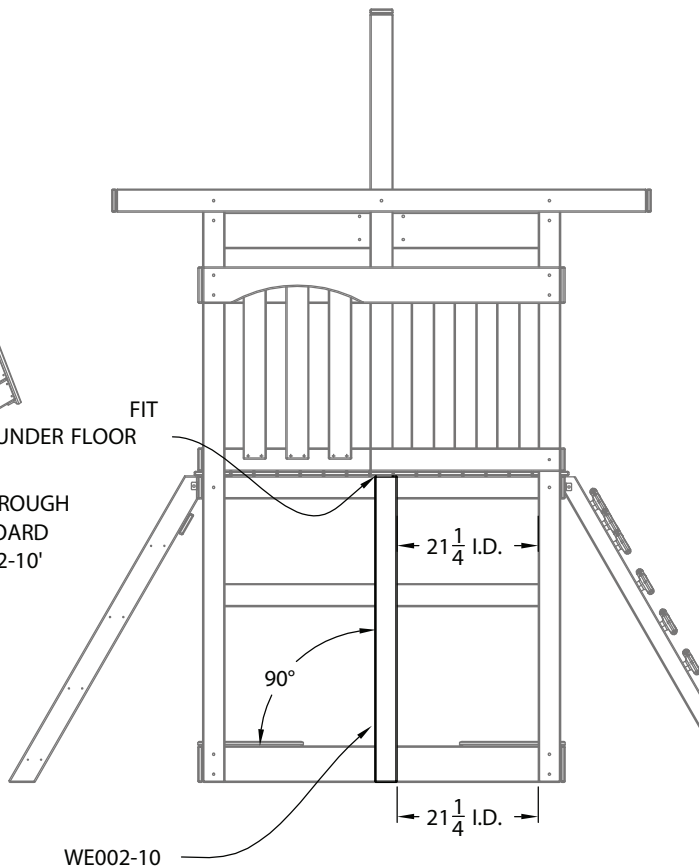

Phase 13:

HAND GRIP ATTACHMENT

Phase Parts

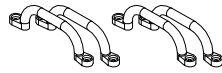

(2 PAIR) SAFETY HANDLE
BP007-Y

PLEASE REFER TO
ACCESSORY PLAN FOR
INSTALLATION INSTRUCTIONS
AND HARDWARE.

*Pre-drill holes with a 1/8" drill bit
*Install all safety handles as shown.

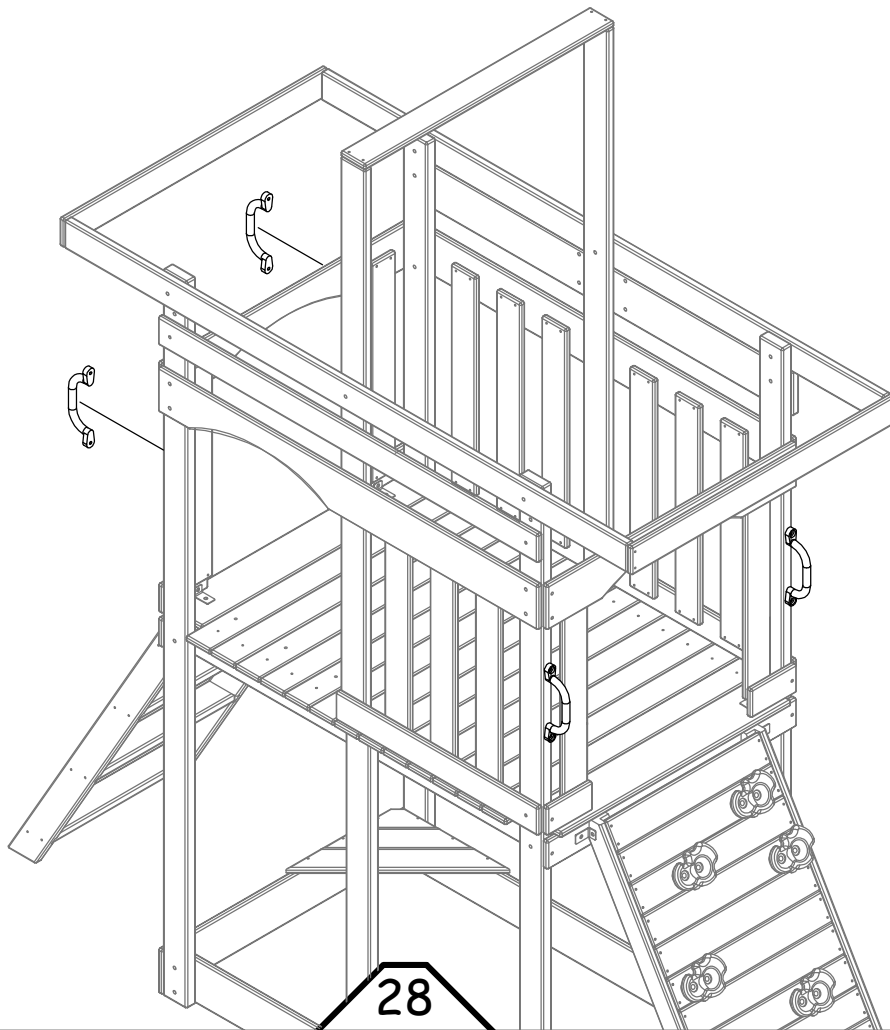
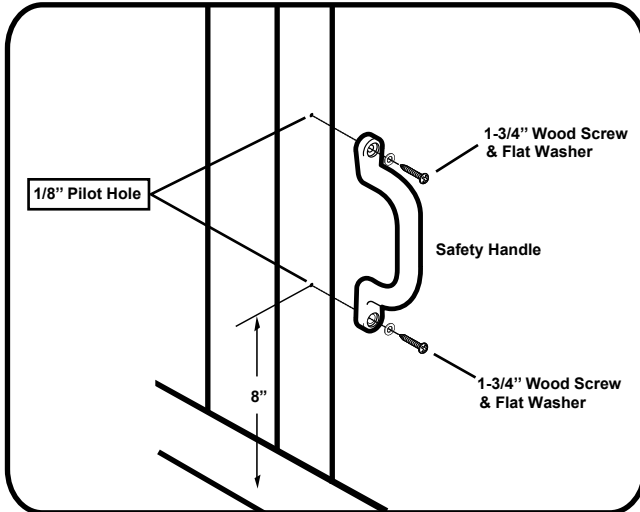

Phase 14:

SWING BEAM ASSEMBLY

Phase Hardware

Fender Washer

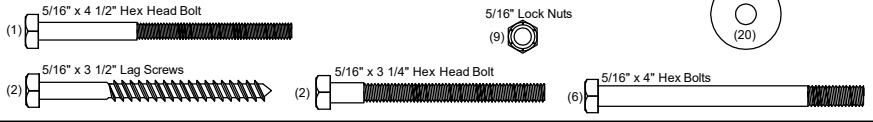

Phase Parts

(1) 3 5/16 X 5 5/16 X 89 1/2 SWING BEAM - LA251



(2) 1 3/8 X 3 5/16 X 82 1/2 SWING ANGLE BRACE - LG252



(1) 3 5/16 X 2 11/16 X 83 SWING END BEAM - LD254



(1) 1 3/8 X 3 5/16 X 89 SWING GROUND BOARD - LG253

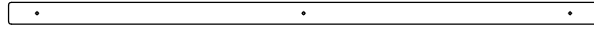

(2) 100° TRIANGLE PLATE - M100



(2) GREEN ANGLE BRACKET (5") - M005



STEP 1:

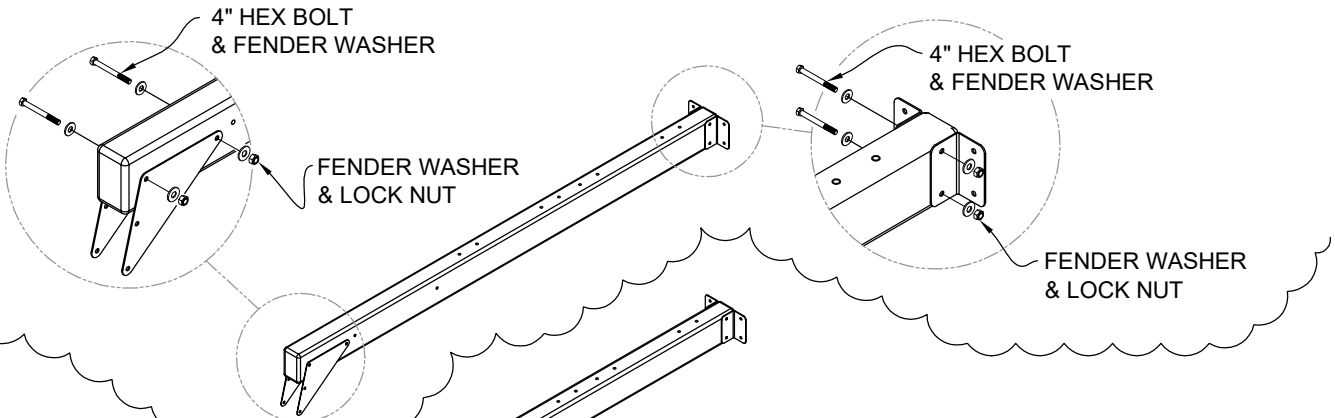

STEP 2:

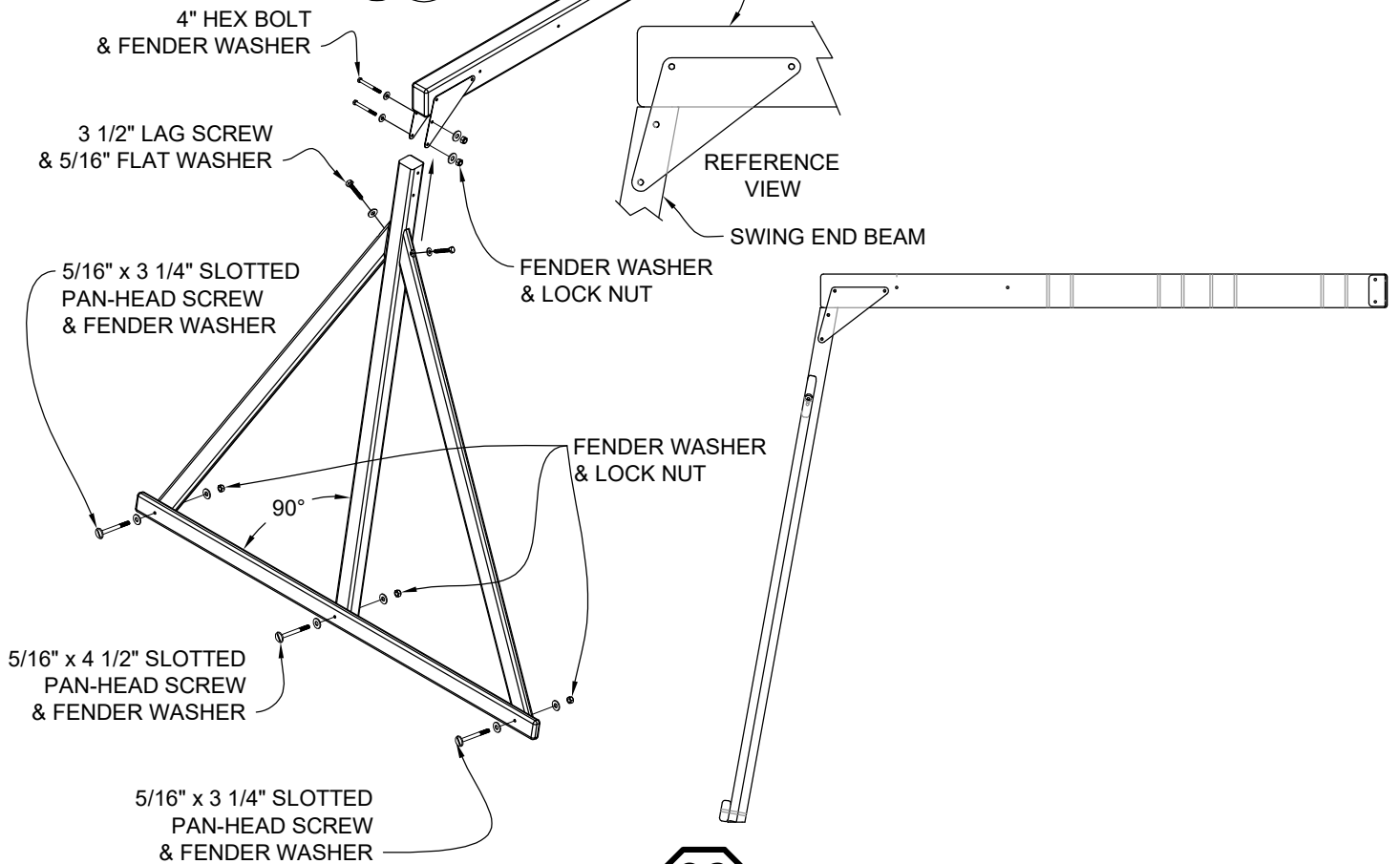

Phase Hardware

PLEASE REFER TO THE SWING HANGER, SWING SEAT,
AND GLIDER ACCESSORY PLANS FOR INSTALLATION
INSTRUCTIONS AND HARDWARE.

Phase Parts

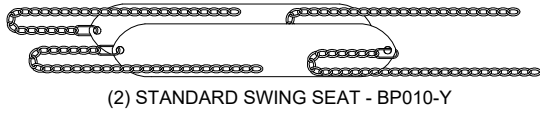

(2) STANDARD SWING SEAT - BP010-Y

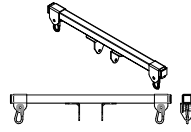

(1 PAIR) GLIDER BRACKET
BP 020

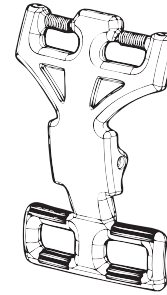

(2) GLIDER ARM

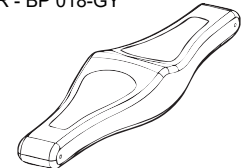

(1) GLIDER SEAT

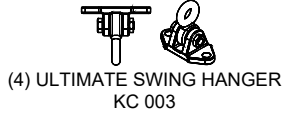

(4) ULTIMATE SWING HANGER
KC 003



(4) CHAIN w/ EYE BOLT

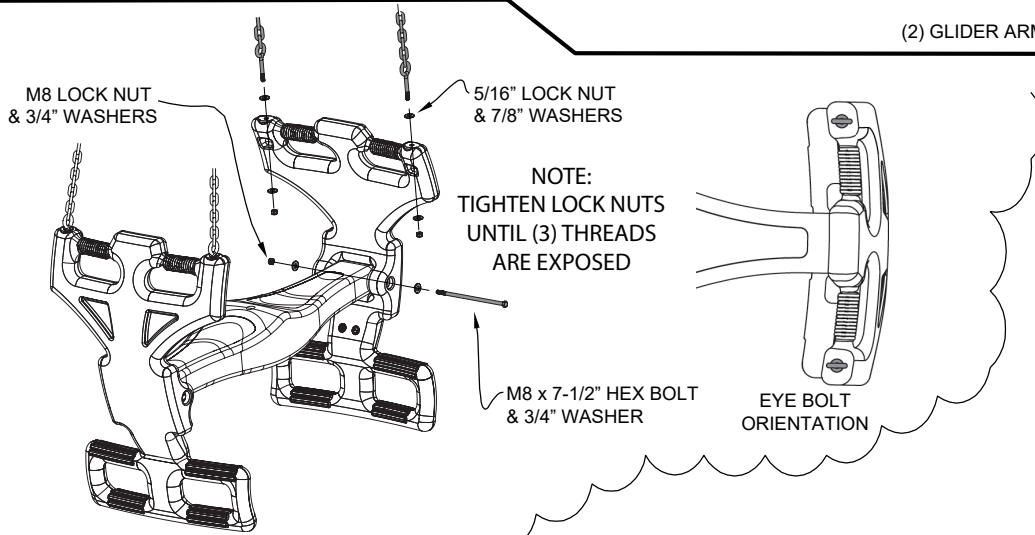

STEP 2:

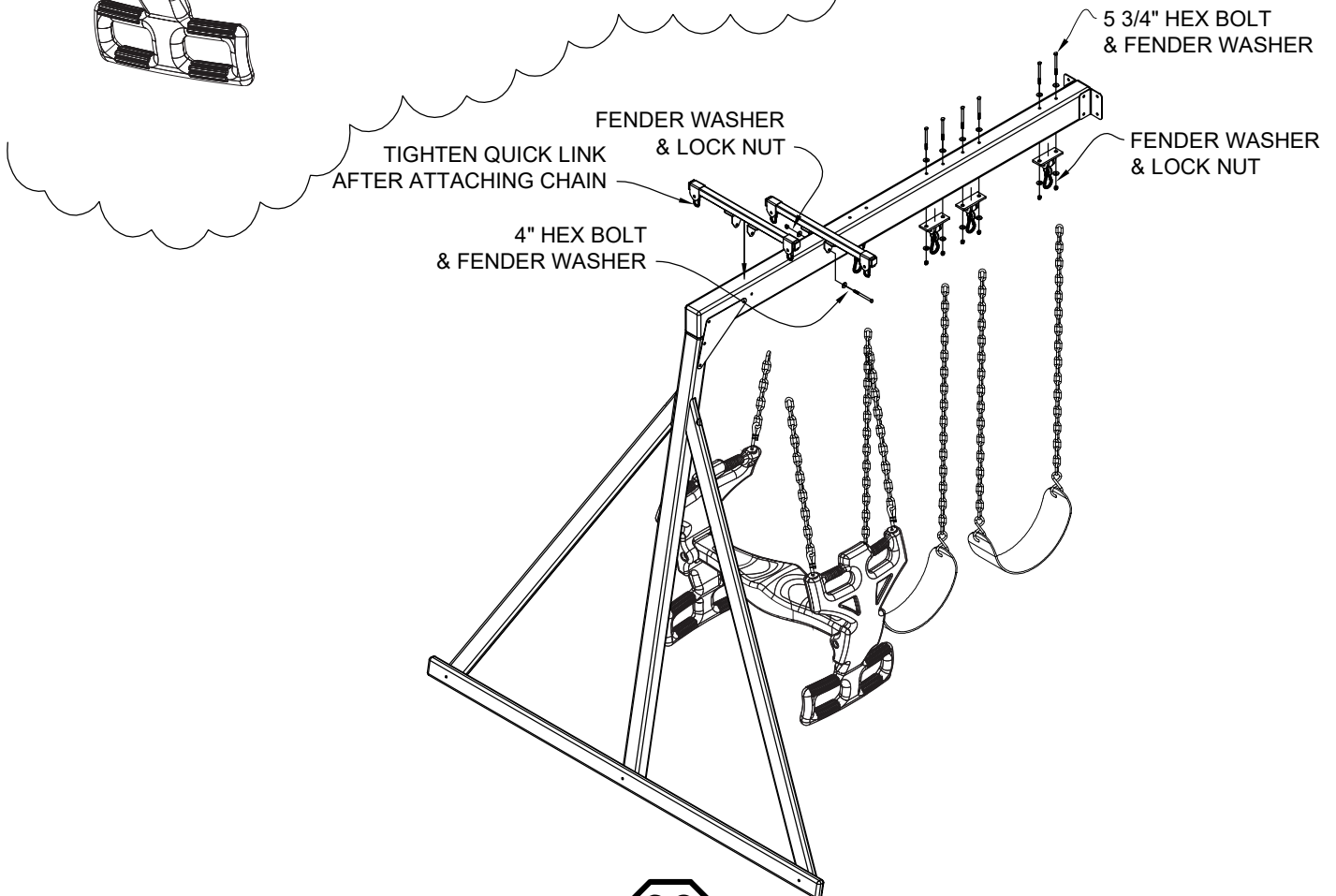

Phase 16:

SWING BEAM
ATTACHMENT

Phase Hardware

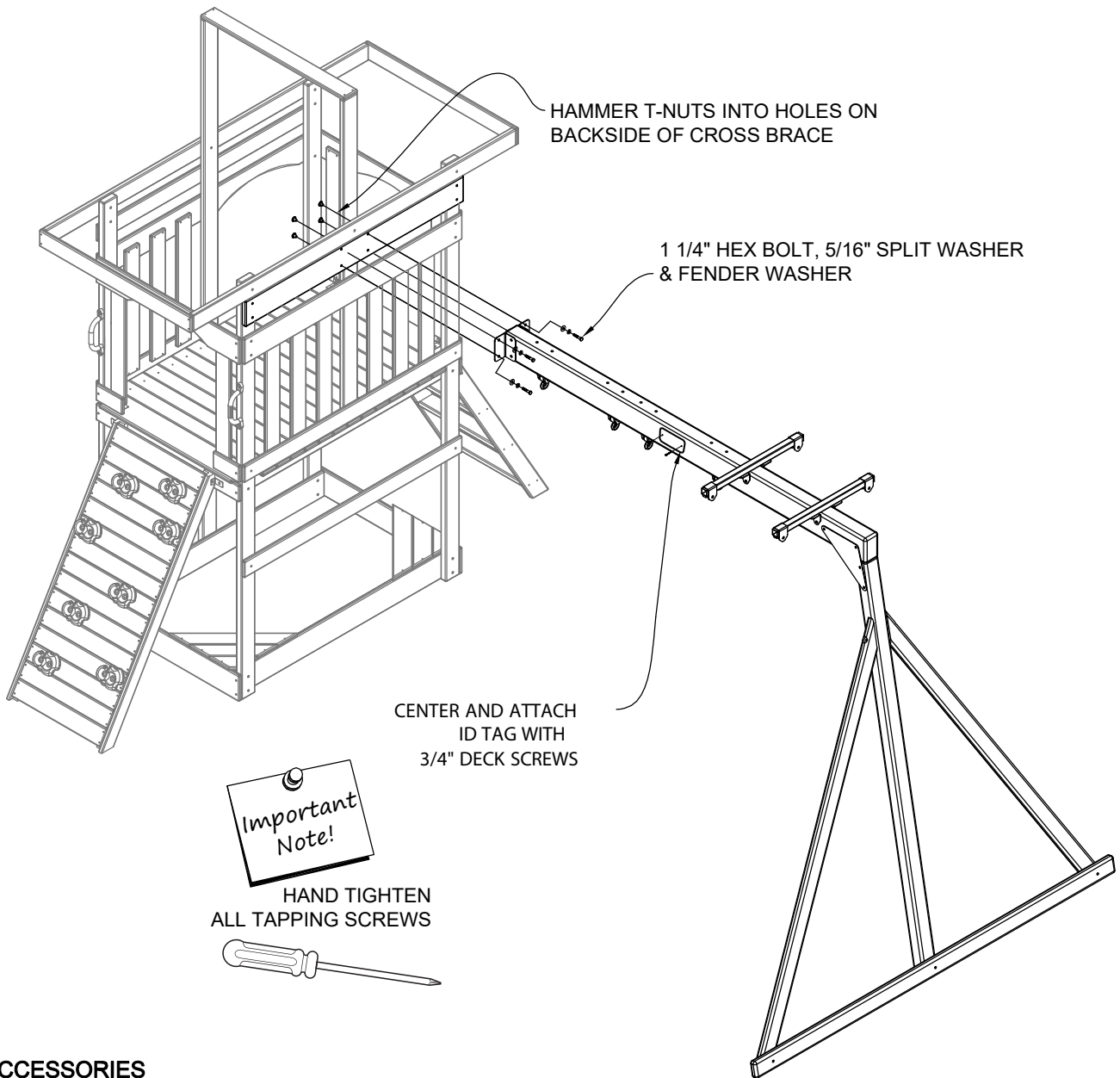
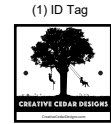
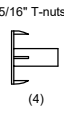
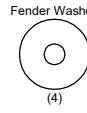
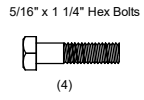

**Important
Note!**

HAND TIGHTEN
ALL TAPPING SCREWS

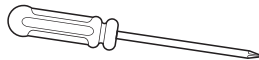

**SWING ACCESSORIES
NOT SHOWN FOR CLARITY
(DO NOT ALLOW CHILDREN TO PLAY ON
FORT / SWING ACCESSORIES UNTIL ASSEMBLY IS COMPLETE)**

Phase 17: TARP ATTACHMENT

Phase Hardware

PLEASE REFER TO THE HARDWARE INCLUDED WITH YOUR TARP.

Phase Parts

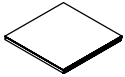

(2) FORT TARP (GREEN)

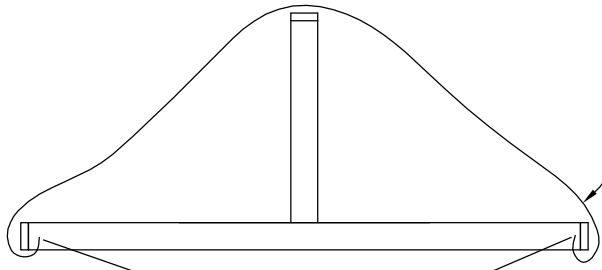

STRETCH TARP TIGHT OVER SUPPORTS

3/4" TAPPING SCREWS
3 EACH SIDE

INSIDE VIEW

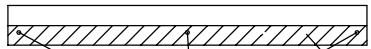

TARP

3/4" TAPPING SCREWS



Important Note!

DO NOT OVER TIGHTEN TAPPING SCREWS!

Important Note!

HAND TIGHTEN ALL TAPPING SCREWS

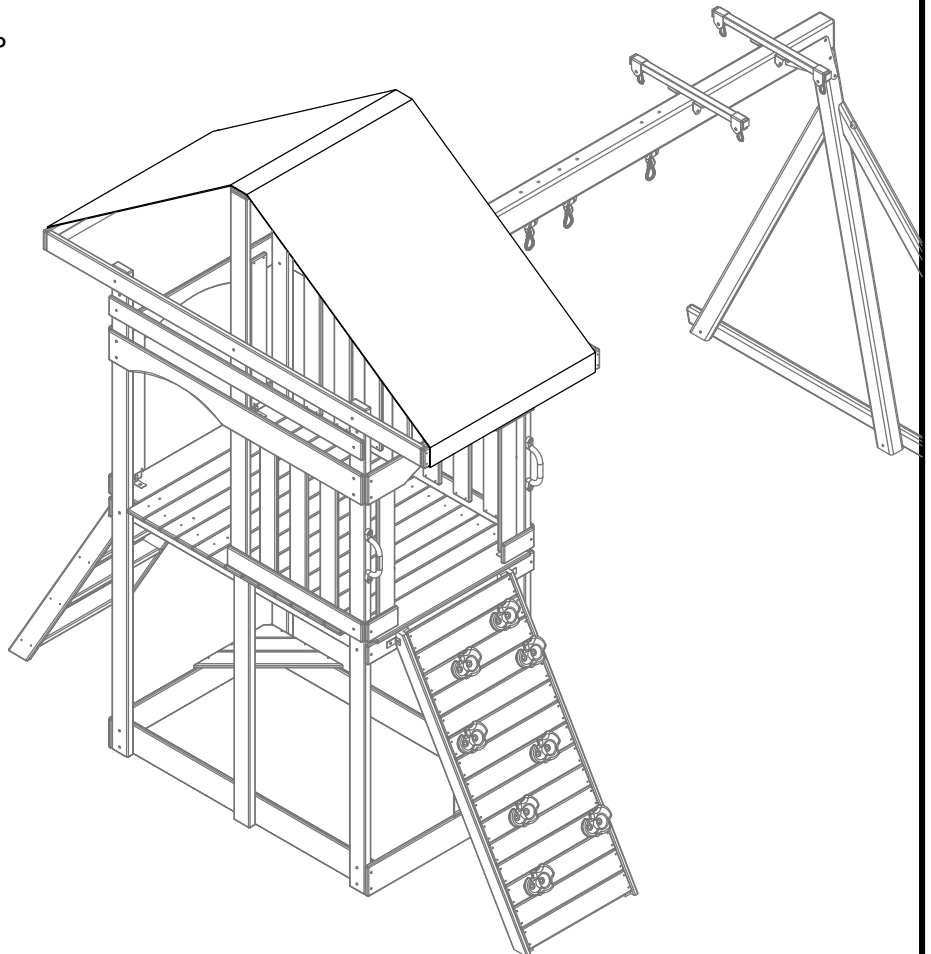
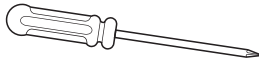

SWING ACCESSORIES
NOT SHOWN FOR CLARITY
(DO NOT ALLOW CHILDREN TO PLAY ON
FORT / SWING ACCESSORIES UNTIL ASSEMBLY IS COMPLETE)

Phase 18:

TABLE RAILS

Phase Hardware

1" Truss Head Screw

(4)



Phase Parts

(2) 1 X 3 1/2 X 35 TABLE LEG - WC007-10

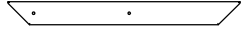

(2) GREEN L-BRACKET (SMALL) - M002



FLUSH WITH
INSIDE OF
UPRIGHTS

21 1/4" I.D.

1" Truss Head Screw

Important
Note!

HAND TIGHTEN
ALL TAPPING SCREWS

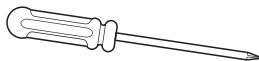

FLUSH

LEGS ARE TO BE LEVEL WITH EACH OTHER
AND RESTING ON THE GROUND

21 1/4"

Phase 19: TABLE ASSEMBLY

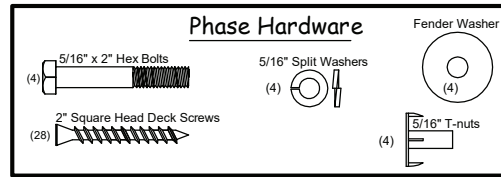

Phase Parts

(2) 1 X 3 1/2 X 17 TABLE BRACE - WC008-10

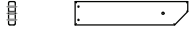

(2) 1 X 3 1/2 X 10 TABLE BRACE - WC009-10



(5) 11/16 X 3 1/2 X 21 1/4 SAFETY / TABLE SLAT - WA014-10

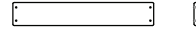

2" DECK SCREWS
(THROUGH
BRACE INTO
UPRIGHT EDGE)

MAKE SURE
BRACES
ARE LEVEL

WC009-10

WC008-10

T-NUTS

2" HEX BOLT
SPLIT WASHER
& FENDER WASHER

2" DECK SCREWS

Phase 20:

SLIDE ATTACHMENT

Phase Hardware

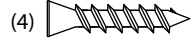

(4) 1 1/4" Deck Screws

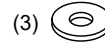

(3) 1/4" Flat Washer

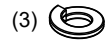

(3) 1/4" Lock Washer

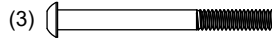

(3) 1/4" x 2" Button Head Bolts



(3) 1/4" T-Nut

Phase Parts



(1) 8' SLIDE (GREEN)

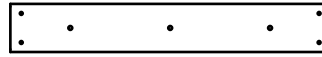

(1) 11/16" X 3 1/2" X 22" SLIDE SUPPORT - WM248

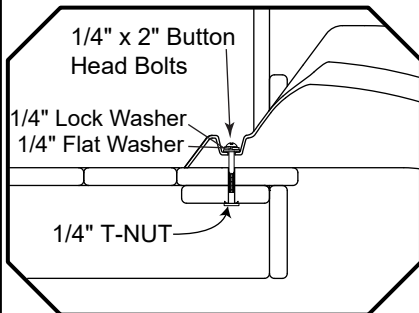

SIDE VIEW

ALIGN SLIDE WITH PRE-DRILLED HOLES ON DECK.

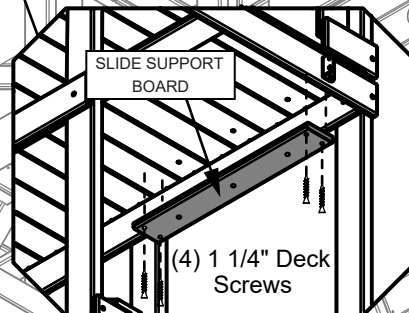

(4) 1 1/4" Deck Screws

ALIGN HOLES IN SUPPORT BOARD WITH HOLE IN UNDERSIDE OF DECK BOARDS.

Phase Parts

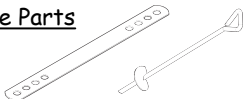

(4) ANCHOR PACK w/ HDW
BP001-B

Phase Hardware

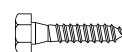

(4) 1-1/2" LAG BOLT



(4) FLAT WASHER

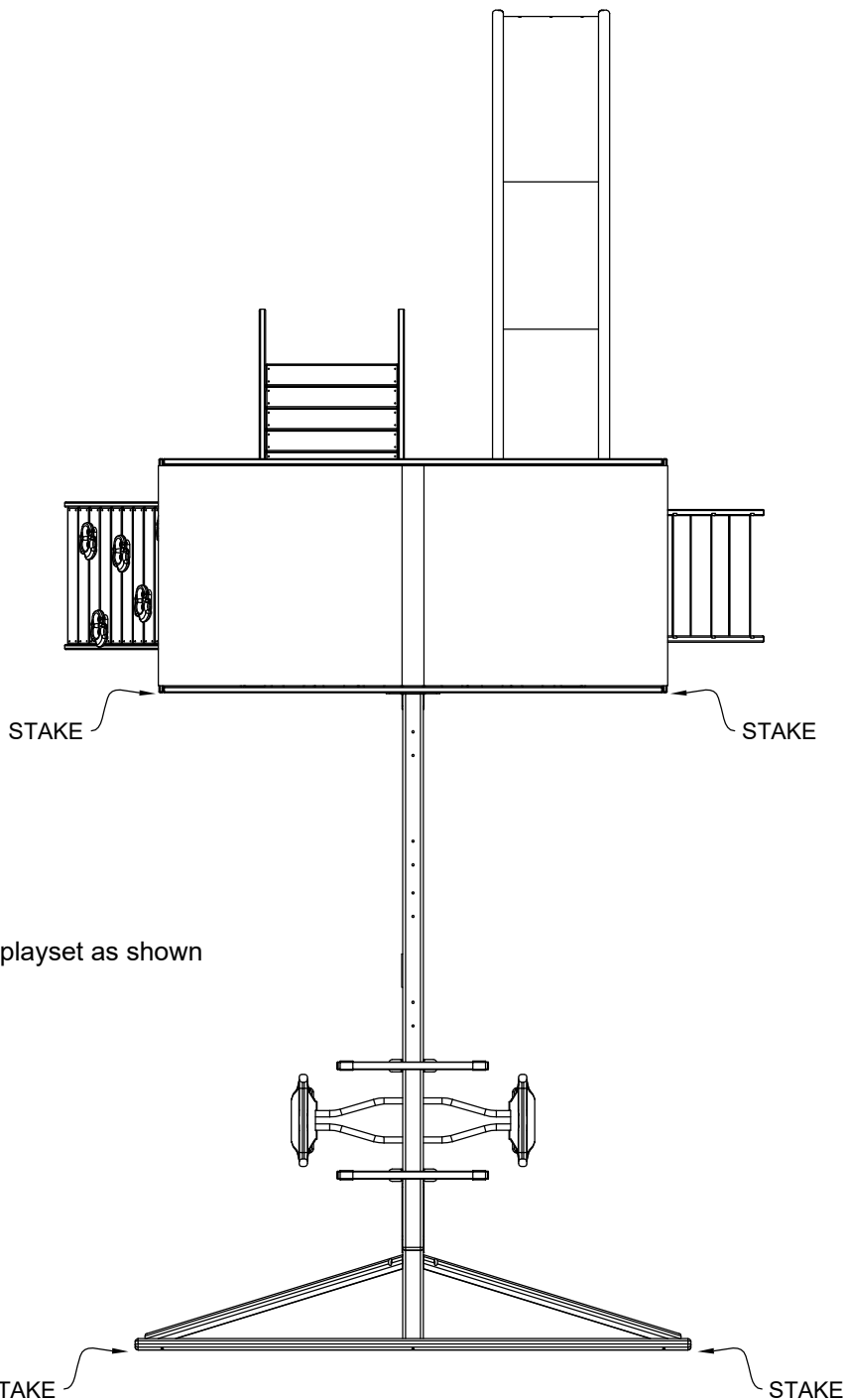
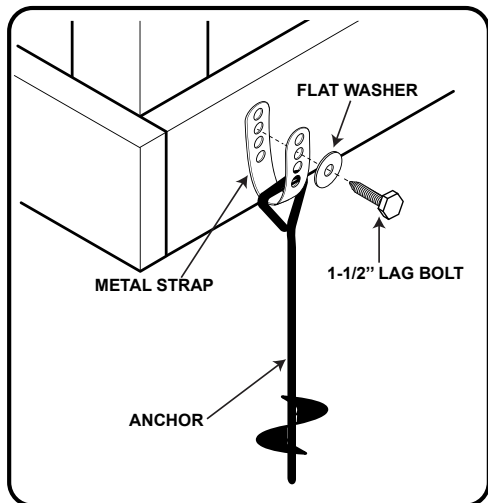

*Place stakes into the ground next to playset as shown



Note: Failure to use stakes can void warranty & cause injury.

Final Step: Double check and make sure every bolt, screw and nut is tight. Make sure every board is secure. Make sure the fort is level and enjoy your playset.

LIMITED WARRANTY

Creative Cedar Design (CCD) offers many fun, interactive, and safe play sets. We only guarantee the original purchaser that this product is free of defects for 30 days from the date of purchase. The product registration card, along with a dated purchase receipt, must be returned to CCD within 30 days.

Within a 30 day period, CCD will repair or replace, at our option, defective merchandise free of charge, provided that the defective part is a manufacturer's defect and not seasonal check. CCD requires photographs of the part in question. The customer service center must be contacted for authorization for all warranty related service. After the 30 day period, the customer is responsible for all shipping and handling charges, even if the warranty claim has been approved. Depending on the size of the part, quantity of the order, availability of part at the time, the claim can take between 1-3 weeks.

Under this warranty there will be a replacement for the defective component of the play set. A 1-year Warranty is available on all components with a manufacturer's defect. A 10-year Limited Warranty is available on wood parts (4x6 and 4x4) against wood rotting and termite damage. This guarantee is effective only if the product is used for the purpose for which it was designed, maintained with accordance to the instructions, and installed at a residential, single family dwelling.

The warranty does not cover, (a) products which have been damaged by acts of God, negligence, misuse, or accident, or which have been modified or repaired by unauthorized persons; (b) the cost of labor; (c) the cost of shipping the product, any part, or any replacement product or part; (d) damage caused by the addition of any accessories not sold by CCD.

Cosmetic defects that do not affect the structural integrity of the product, or natural defects of wood such as warping, checking or any other physical properties of wood that do not present a safety hazard, are not covered by this warranty. Defects that develop because the product is exposed to extreme climate conditions are not covered by this warranty. Defects that develop as a result of faulty or improper installation of the product are also not covered by this warranty.

For warranty service or replacement part information, please visit our website at www.creativecedardesigns.com and submit a request. If you have any additional questions, please call 1-888-363-4967.

Replacement parts are available for purchase after the warranty expires. Please contact us by email at custservice@creativecedardesigns.com for details.

Warranty: 1 Year for all Components	
Days from Date of Purchase	Cost to Customer
With in 30 days	No Cost
After 30 days , but within 1 year	Shipping and Handling (S&H)

Warranty: 10 Year Pro Rated for Wood Parts (4x4 and 4x6 ONLY against wood rot and termite damage)	
Years from Date of Purchase	Cost to Customer
0-1 (after first 30 days through Year 1)	Cost of S&H and 0% on part
2-3	Cost of S&H and 20% on part
4-5	Cost of S&H and 40% on part
6-7	Cost of S&H and 60% on part
8-9	Cost of S&H and 80% on part
Over 10	Cost of S&H and 100% on part

Warranty claim procedure

If you are confident that your play system has been installed and maintained properly, and you have a warranty claim, proceed with the following steps:

1. We will need copy of your proof of purchase (Vendor sales receipt only.)
2. We require a brief written description of the warranty issue.
3. Photos of warranted parts and of the entire play system.

If **any** of the above steps are not completed, there may be delays in the completion of your claim, or possibly warranty cancellation.

Mail information to:

Creative Cedar Designs

2700 Riverside Dr

Chattanooga, TN 37406

Or email at

custservice@creativecedardesigns.com

Our customer service department will review the claim and make contact with the customer by mail or by phone.

1-888-363-4967

PRODUCT REGISTRATION CARD

Please complete this Product Registration Card along with a copy of the receipt and return to Creative Cedar Designs, within 30 days of original purchase in order to validate time of purchase for warranty.
Or register at www.creativecedardesigns.com

Name: _____

Address: _____

City, State, Zip Code: _____

Phone: _____

Email Address: _____

Date of Purchase: _____

Purchased Through: _____

City, State, Zip Code: _____

Playset Name: _____ Playset Model: _____

Overall, how would you rate the quality of our product?

- Excellent
- Good
- Satisfied
- Poor
- Unsatisfied

Would you recommend our product to family and friends?

- Yes
- No

What age group are your children?

- 3-4
- 5-6
- 7-8
- 9-10

How did you hear about us?

- In Store Display
- Sales Person
- Advertisement
- Internet
- Family and Friends

Additional Comments: _____

PRODUCT REGISTRATION CARD

Please complete this Product Registration Card along with a copy of the receipt and return to Creative Cedar Designs, within 30 days of original purchase in order to validate time of purchase for warranty.

FOLD HERE

Place
Stamp
Here

Creative Cedar Designs

2700 Riverside Dr.

Chattanooga, TN 37406