



INSTRUCTIONS D'ASSEMBLAGE
ASSEMBLY INSTRUCTIONS

MONARCH
SPECIALTIES INC.

I 2480

TABLE D'APPOINT -
32"H / TAUPE FONCE

ACCENT TABLE -
32"H / DARK TAUPE



**POUR DE L'ASSISTANCE OU POUR COMMANDER
DES PIÈCES CONTACTEZ NOTRE DÉPARTEMENT
DE SERVICE À LA CLIENTÈLE.**

**FOR ASSISTANCE OR TO ORDER PARTS
CONTACT OUR CUSTOMER SERVICE DEPARTMENT**

WWW.MONARCHSERVICE.COM

LISTE DES PIÈCES
PARTS LIST

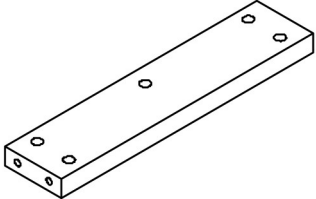
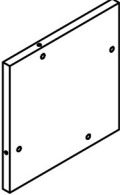
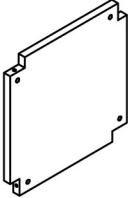
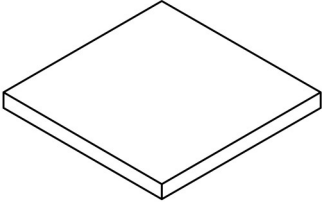
| PIÈCE / PART # | IMAGE | DESCRIPTION | QTY / QTÉ |
|----------------|---|------------------------------------|-----------|
| 1 |  | LEG PATTE | 4 |
| 2 |  | CROSSBAR BARRE TRANSVERSALE | 4 |
| 3 |  | SHELF PANEL PANNEAU DE TABLETTE | 1 |
| 4 |  | BOTTOM SHELF ÉTAGÈRE DU BAS | 1 |
| 5 |  | TABLE TOP SURFACE DE TABLE | 1 |

LISTE DES PIÈCES
PARTS LIST

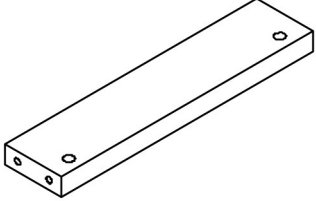
| PIÈCE / PART # | IMAGE | DESCRIPTION | QTY / QTÉ |
|----------------|---|--------------------------------|-----------|
| 6 |  | CROSSBAR BARRE TRANSVERSALE | 4 |

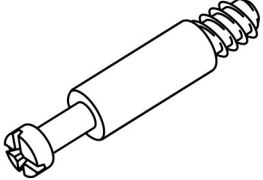
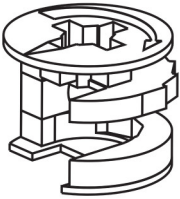
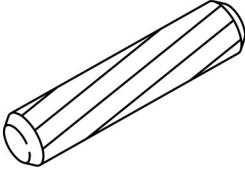
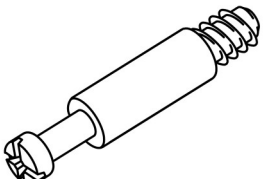
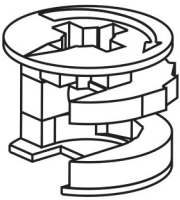

LISTE DES PIÈCES DE MONTAGE
HARDWARE LIST

| PIÈCE / PART # | IMAGE | DESCRIPTION | QTY / QTÉ |
|----------------|---|--|-----------|
| A |  | CAM LOCK SCREW - 1 1/8" VIS CAM LOCK - 1 1/8" | 16 |
| B |  | CAM LOCK CONNECTOR - Ø5/8" ÉCROU CAM LOCK - Ø5/8" | 16 |
| C |  | WOOD DOWEL - Ø3/8" X 1" GOUJON DE BOIS - Ø3/8" X 1" | 8 |
| D |  | CAM LOCK SCREW - 1" VIS CAM LOCK - 1" | 16 |
| E |  | CAM LOCK CONNECTOR - Ø1/2" ÉCROU CAM LOCK - Ø1/2" | 16 |

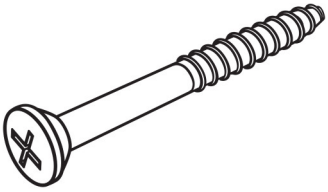
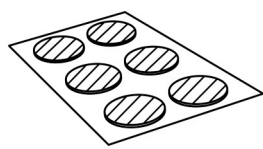
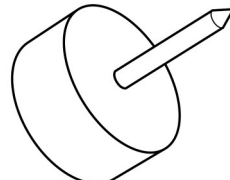
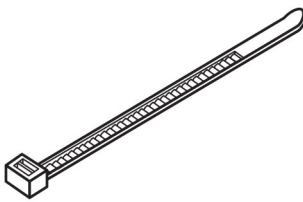
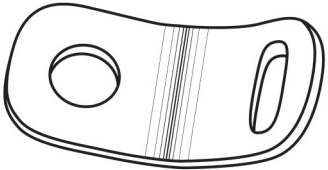
LISTE DES PIÈCES DE MONTAGE
HARDWARE LIST

| PIÈCE / PART # | IMAGE | DESCRIPTION | QTY / QTÉ |
|----------------|---|--|-----------|
| F |  | ASSEMBLING SCREW - Ø1/8" X 2 3/8" VIS D'ASSEMBLAGE - Ø1/8" X 2 3/8" | 4 |
| G |  | FINISHING STICKER - Ø1/2" COLLANT DE FINITION - Ø1/2" | 4 |
| H |  | FLOOR PROTECTOR - Ø5/8" PROTECTEUR DE PLANCHER - Ø5/8" | 4 |
| I |  | ZIP TIE - 7 3/4" X 1/8" ATTACHE AUTOBLOQUANTE - 7 3/4" X 1/8" | 1 |
| J |  | METAL BRACKET - 1/2" X 1/2" SUPPORT DE MÉTAL - 1/2" X 1/2" | 2 |

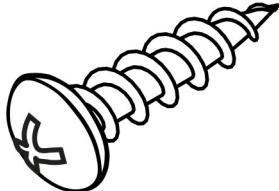
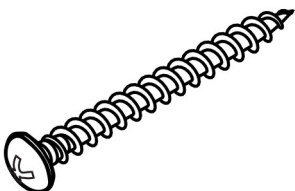
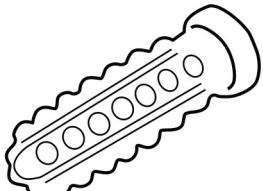
LISTE DES PIÈCES DE MONTAGE
HARDWARE LIST

| PIÈCE / PART # | IMAGE | DESCRIPTION | QTY / QTÉ |
|----------------|---|--|-----------|
| K |  | ASSEMBLING SCREW - Ø1/8" X 1" VIS D'ASSEMBLAGE - Ø1/8" X 1" | 1 |
| L |  | ASSEMBLING SCREW - Ø1/8" X 1 1/2" VIS D'ASSEMBLAGE - Ø1/8" X 1 1/2" | 1 |
| M |  | ANCHOR - Ø3/8" X 1 1/2" ANCRE - Ø3/8" X 1 1/2" | 1 |
| N |  | GLUE COLLE | 1 |

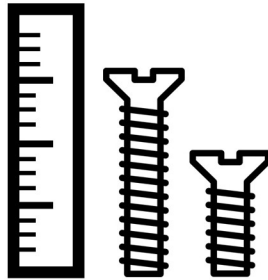

OUTIL DE VÉRIFICATION DE DIMENSIONS DES PIÈCES
HARDWARE DIMENSIONS VERIFICATION TOOL

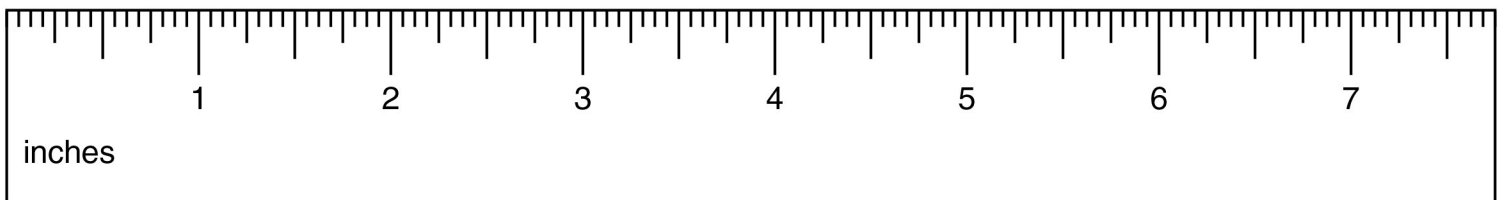

ÉTAPE / STEP 1

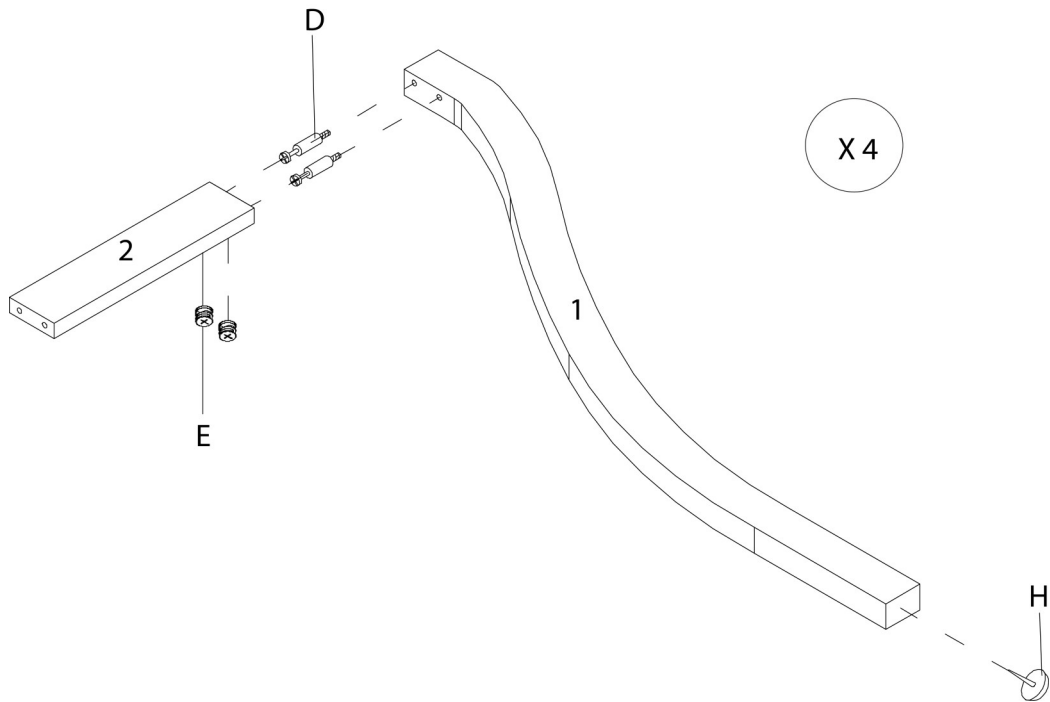

ÉTAPE / STEP 2

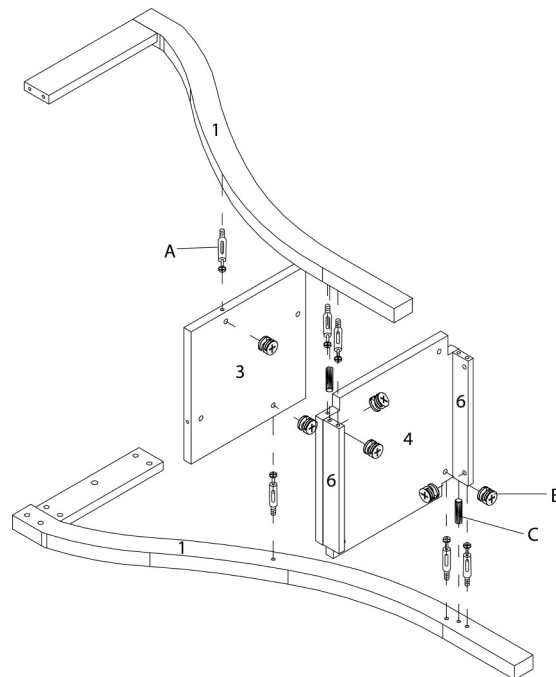

ÉTAPE / STEP 3

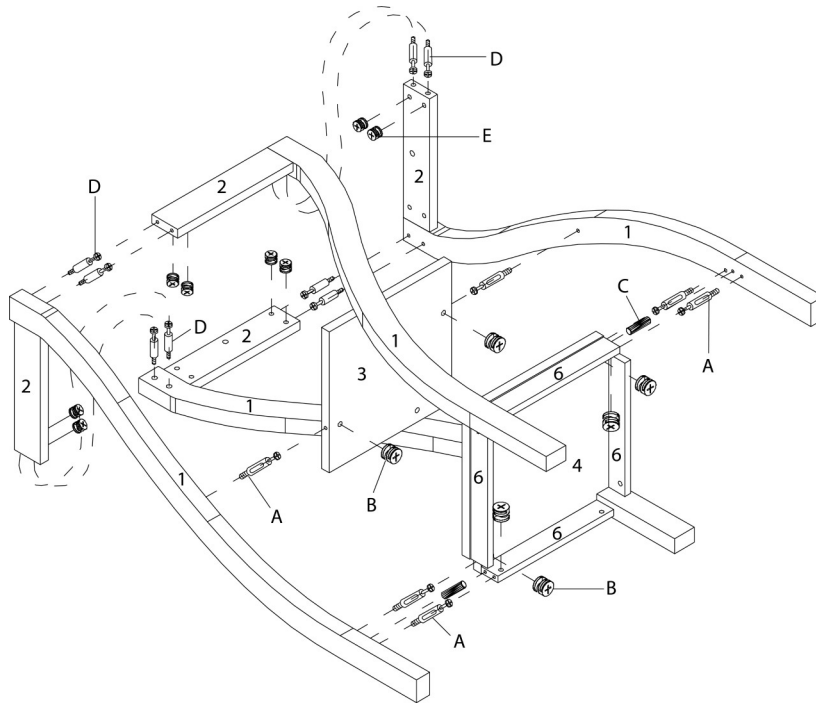

ÉTAPE / STEP 4

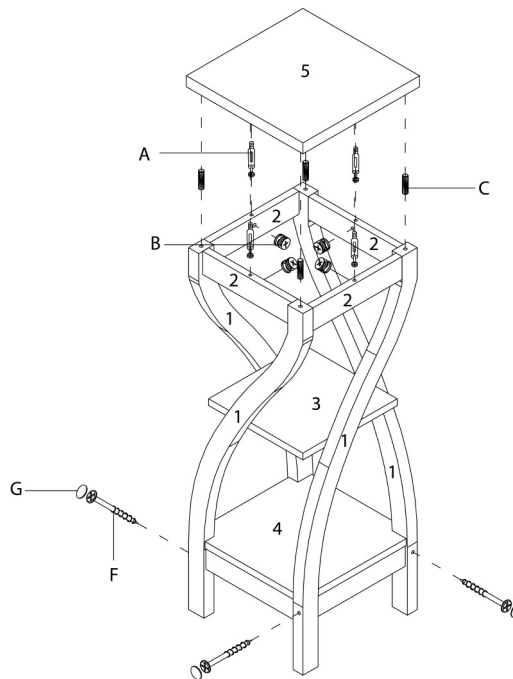

ÉTAPE / STEP 5

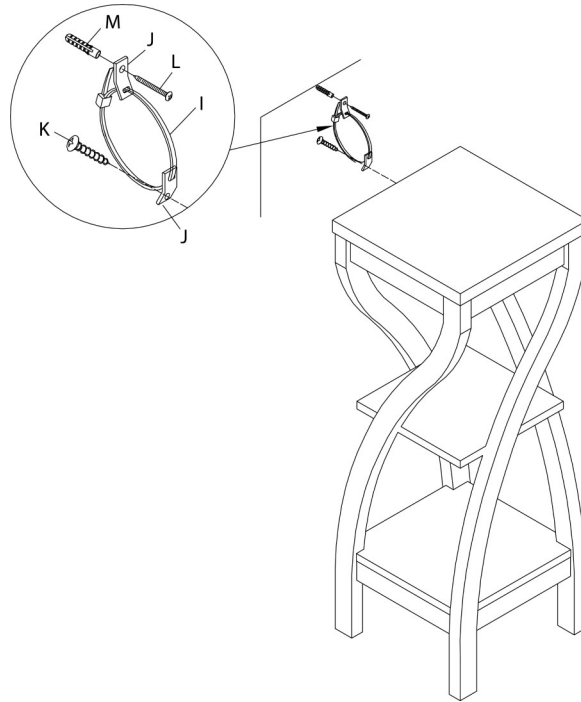

ÉTAPE / STEP 6

