



**INSTRUCTIONS D'ASSEMBLAGE**  
**ASSEMBLY INSTRUCTIONS**

---

**M**ONARCH  
SPECIALTIES INC.

**I 3332**

---

**TABLE D'APPOINT -  
METAL NOIR MARTELE ET VERRE TREMPE**

**ACCENT TABLE -  
HAMMERED BLACK METAL WITH TEMPERED  
GLASS**







**POUR DE L'ASSISTANCE OU POUR COMMANDER  
DES PIÈCES CONTACTEZ NOTRE DÉPARTEMENT  
DE SERVICE À LA CLIENTÈLE.**

**FOR ASSISTANCE OR TO ORDER PARTS  
CONTACT OUR CUSTOMER SERVICE DEPARTMENT**

**WWW.MONARCHSERVICE.COM**

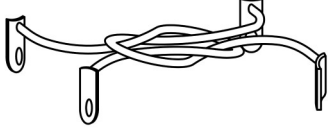
**LISTE DES PIÈCES**  
**PARTS LIST**

PIÈCE / PART #	IMAGE	DESCRIPTION	QTY / QTÉ
1		<p>TOP FRAME CADRE DE SURFACE</p>	1
2		<p>LEG PATTE</p>	4
3		<p>LEG SUPPORT SOUTIEN POUR PATTE</p>	1
4		<p>GLASS TOP SURFACE EN VERRE</p>	1

**LISTE DES PIÈCES DE MONTAGE**  
**HARDWARE LIST**

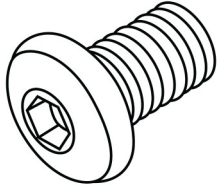
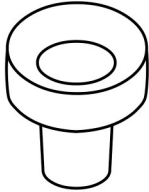
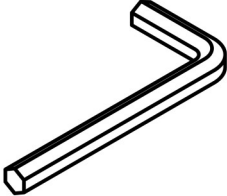
PIÈCE / PART #	IMAGE	DESCRIPTION	QTY / QTÉ
A		<p>ASSEMBLING BOLT - Ø1/4" X 1/2"</p> <p>BOULON D'ASSEMBLAGE - Ø1/4" X 1/2"</p>	12
B		<p>CLEAR BUMPER - Ø1/4"</p> <p>COUSSINET TRANSPARENT - Ø1/4"</p>	4
C		<p>HEX KEY</p> <p>CLÉ HEXAGONALE</p>	1

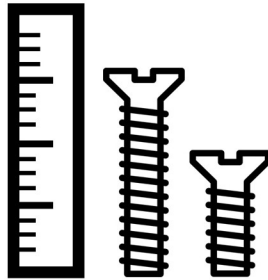

OUTIL DE VÉRIFICATION DE DIMENSIONS DES PIÈCES  
HARDWARE DIMENSIONS VERIFICATION TOOL

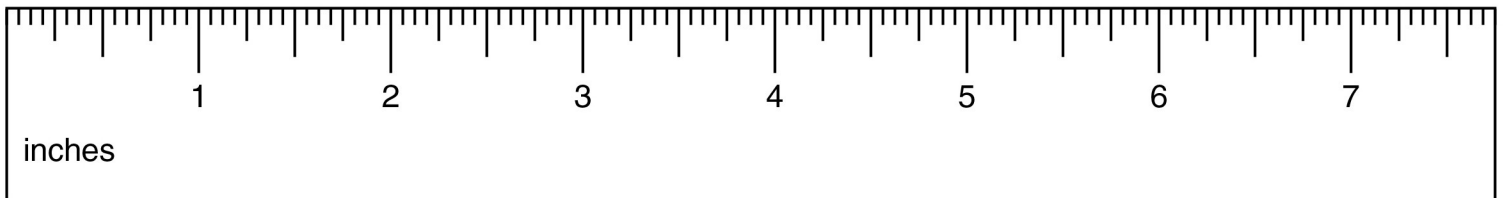

ÉTAPE / STEP 1

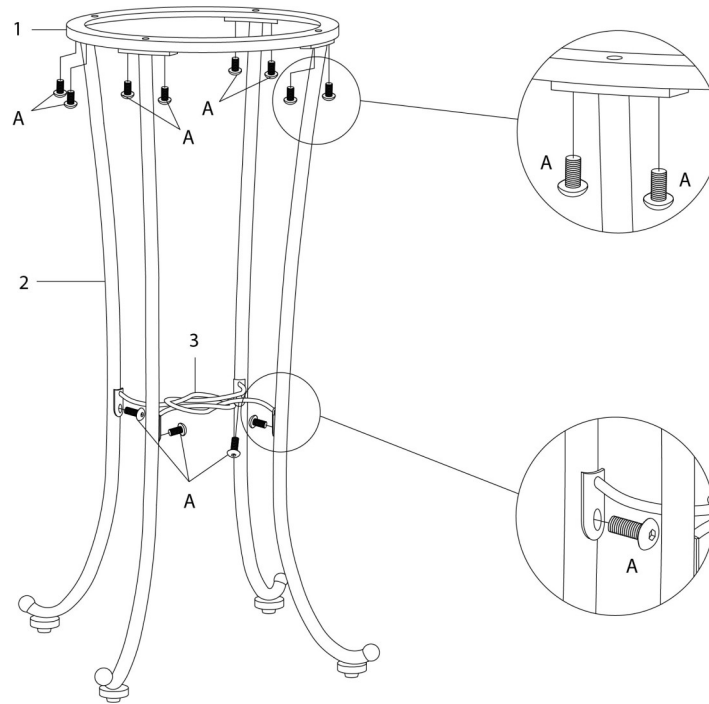

ÉTAPE / STEP 2

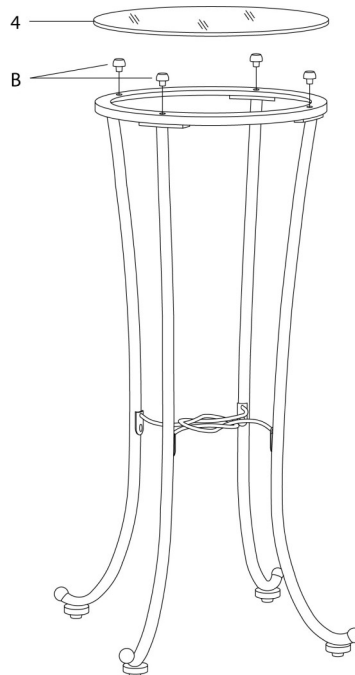

ÉTAPE / STEP 3

