



**INSTRUCTIONS D'ASSEMBLAGE**  
**ASSEMBLY INSTRUCTIONS**

---

**M**ONARCH  
SPECIALTIES INC.

# I 7449

---

**BUREAU -**  
**48" L / FAUX BOIS TAUPE / METAL NOIR**

**COMPUTER DESK -**  
**48" L / TAUPE RECLAIMED WOOD / BLACK METAL**



**POUR DE L'ASSISTANCE OU POUR COMMANDER  
DES PIÈCES CONTACTEZ NOTRE DÉPARTEMENT  
DE SERVICE À LA CLIENTÈLE.**

**FOR ASSISTANCE OR TO ORDER PARTS  
CONTACT OUR CUSTOMER SERVICE DEPARTMENT**

**WWW.MONARCHSERVICE.COM**

**LISTE DES PIÈCES**  
**PARTS LIST**

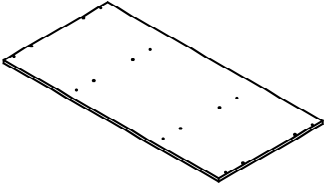
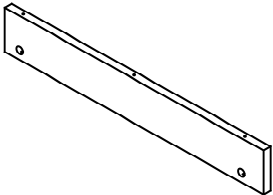
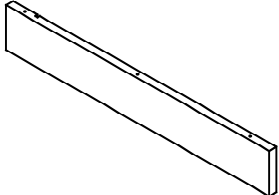
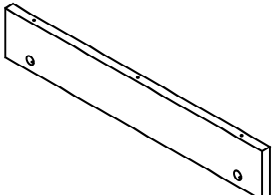
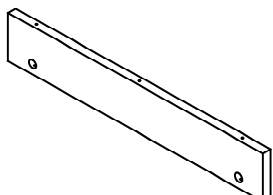
PIÈCE / PART #	IMAGE	DESCRIPTION	QTY / QTÉ
1		DESK TOP SURFACE DU BUREAU	1
2		FRONT FACING LEFT SIDE PANEL PANNEAU DE CÔTÉ GAUCHE	1
3		FRONT FACING RIGHT SIDE PANEL PANNEAU DE CÔTÉ AVANT DROIT	1
4		SUPPORT PANEL PANNEAU DE SOUTIENT	1
5		SUPPORT PANEL PANNEAU DE SOUTIENT	1

**LISTE DES PIÈCES**  
**PARTS LIST**

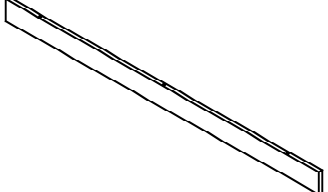
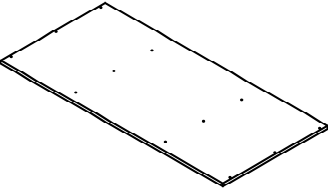
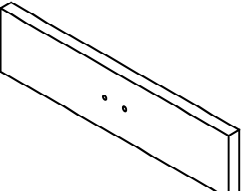
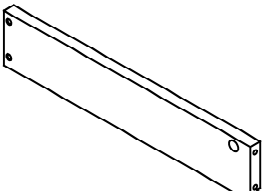
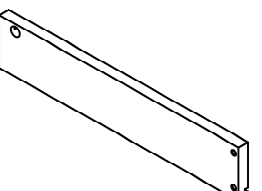
PIÈCE / PART #	IMAGE	DESCRIPTION	QTY / QTÉ
6		BACK PANEL PANNEAU ARRIÈRE	1
7		BOTTOM PANEL PANNEAU DU BAS	1
8		DRAWER FRONT PANEL PANNEAU AVANT TIROIR	2
9		DRAWER SIDE PANEL PANNEAU DE CÔTÉ TIROIR	2
10		DRAWER SIDE PANEL PANNEAU DE CÔTÉ TIROIR	2

**LISTE DES PIÈCES**  
**PARTS LIST**

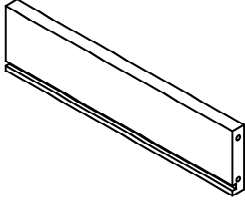
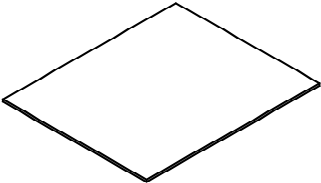
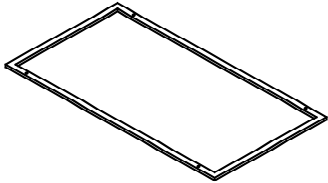
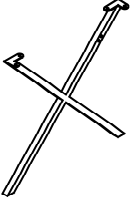
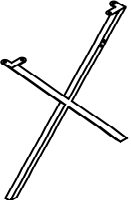
PIÈCE / PART #	IMAGE	DESCRIPTION	QTY / QTÉ
11		DRAWER BACK PANEL PANNEAU ARRIÈRE TIROIR	2
12		DRAWER BOTTOM PANEL PANNEAU DU BAS TIROIR	2
13		TOP FRAME CADRE DE SURFACE	1
14		FRONT FACING LEFT LEG PATTE AVANT GAUCHE	1
15		FRONT FACING RIGHT LEG PATTE AVANT DROITE	1

**LISTE DES PIÈCES**  
**PARTS LIST**

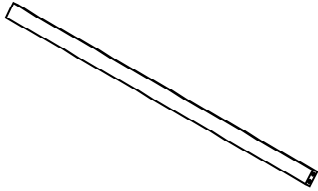
PIÈCE / PART #	IMAGE	DESCRIPTION	QTY / QTÉ
16		SUPPORT BAR BARRE DE SOUTIEN	1

**LISTE DES PIÈCES DE MONTAGE**  
**HARDWARE LIST**

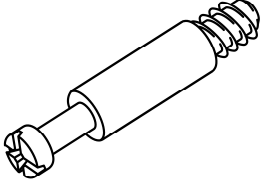
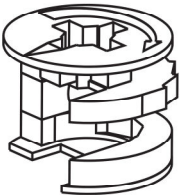
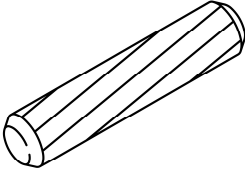
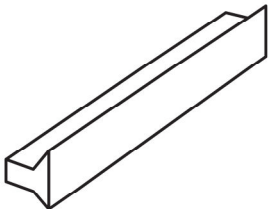
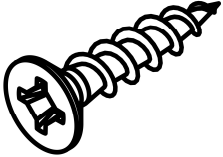
PIÈCE / PART #	IMAGE	DESCRIPTION	QTY / QTÉ
A		CAM LOCK SCREW - Ø1/8" X 1 1/2" VIS CAM LOCK - Ø1/8" X 1 1/2"	12
B		CAM LOCK CONNECTOR - Ø1/2" X 1/2" ÉCROU CAM LOCK - Ø1/2" X 1/2"	12
C		WOOD DOWEL - Ø3/8" X 1 1/8" GOUJON DE BOIS - Ø3/8" X 1 1/8"	22
D		HANDLE POIGNÉE	2
E		ASSEMBLING SCREW - Ø3/8" X 1 1/4" VIS D'ASSEMBLAGE - Ø3/8" X 1 1/4"	20

**LISTE DES PIÈCES DE MONTAGE**  
**HARDWARE LIST**

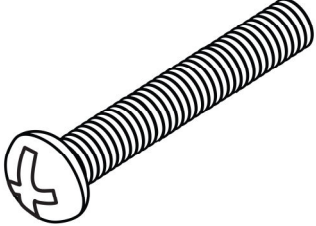
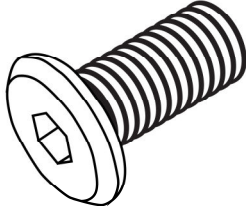
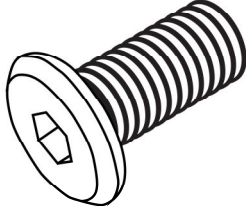
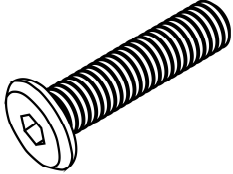
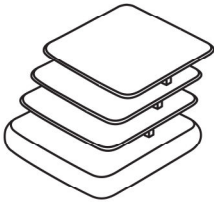
PIÈCE / PART #	IMAGE	DESCRIPTION	QTY / QTÉ
<b>F</b>		<b>ASSEMBLING BOLT - Ø1/8" X 7/8"</b> <b>BOULON D'ASSEMBLAGE - Ø1/8" X 7/8"</b>	<b>4</b>
<b>G</b>		<b>ASSEMBLING BOLT - Ø1/4" X 1/2"</b> <b>BOULON D'ASSEMBLAGE - Ø1/4" X 1/2"</b>	<b>8</b>
<b>H</b>		<b>ASSEMBLING BOLT - Ø1/4" X 3/4"</b> <b>BOULON D'ASSEMBLAGE - Ø1/4" X 3/4"</b>	<b>4</b>
<b>I</b>		<b>ASSEMBLING BOLT - Ø1/4" X 2"</b> <b>BOULON D'ASSEMBLAGE - Ø1/4" X 2"</b>	<b>4</b>
<b>J</b>		<b>FLOOR PROTECTOR - 1" X 1"</b> <b>PROTECTEUR DE PLANCHER - 1" X 1"</b>	<b>4</b>

**LISTE DES PIÈCES DE MONTAGE**  
**HARDWARE LIST**

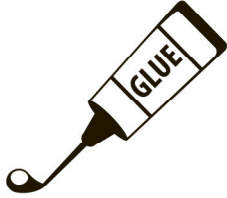
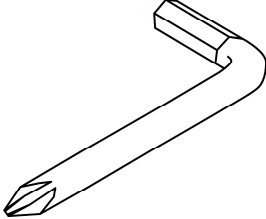
PIÈCE / PART #	IMAGE	DESCRIPTION	QTY / QTÉ
K		GLUE COLLE	1
L		HEX KEY CLÉ HEXAGONALE	1





OUTIL DE VÉRIFICATION DE DIMENSIONS DES PIÈCES  
HARDWARE DIMENSIONS VERIFICATION TOOL



ÉTAPE / STEP 1

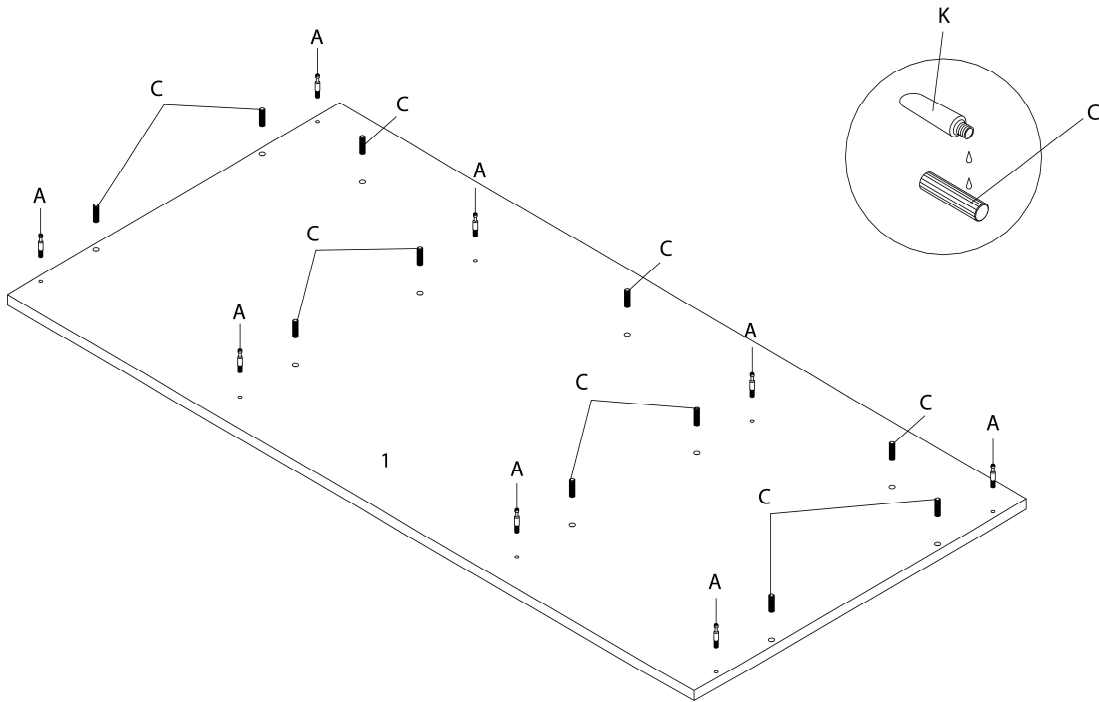

ÉTAPE / STEP 2

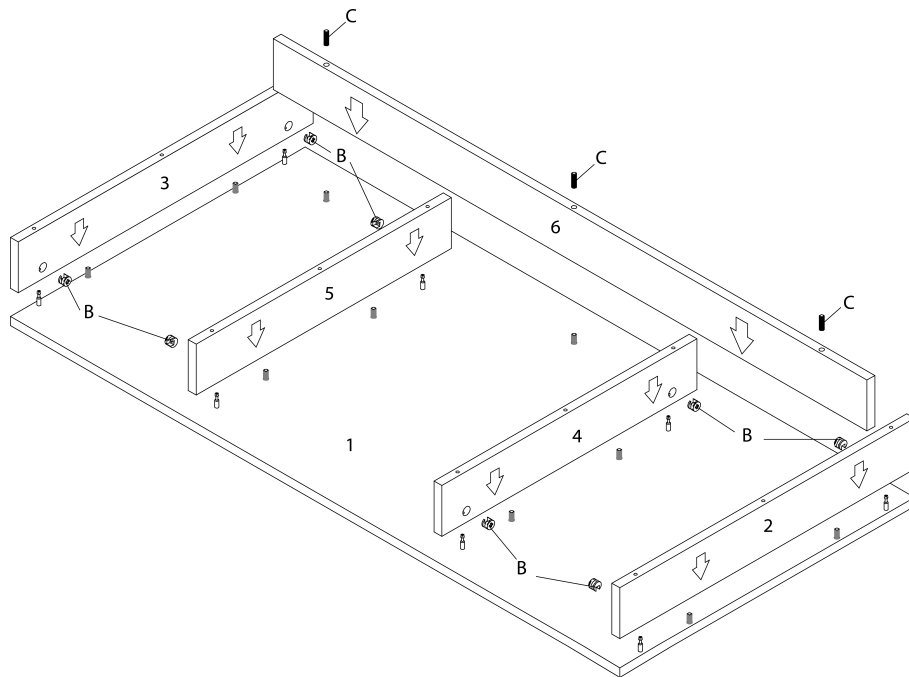

ÉTAPE / STEP 3

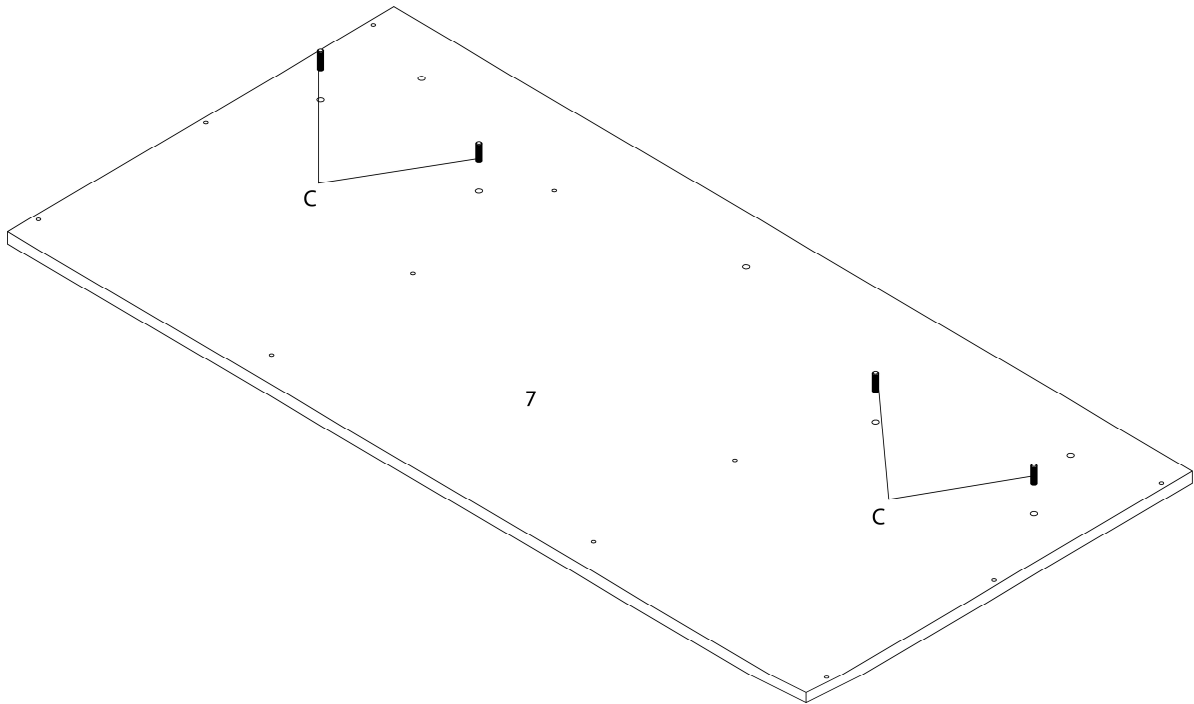

ÉTAPE / STEP 4

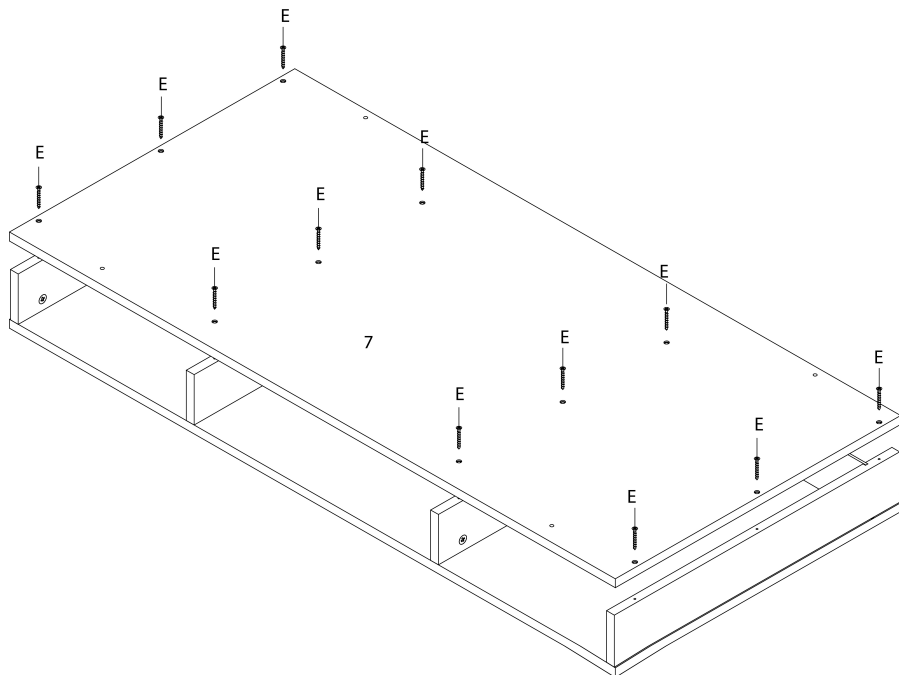

ÉTAPE / STEP 5

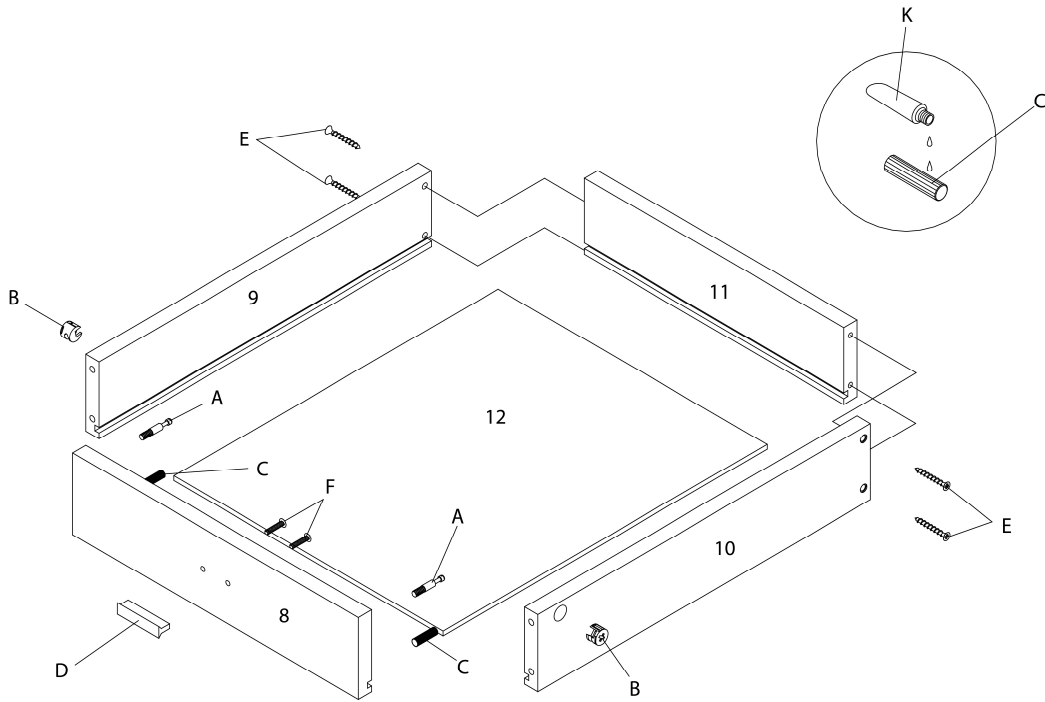

ÉTAPE / STEP 6

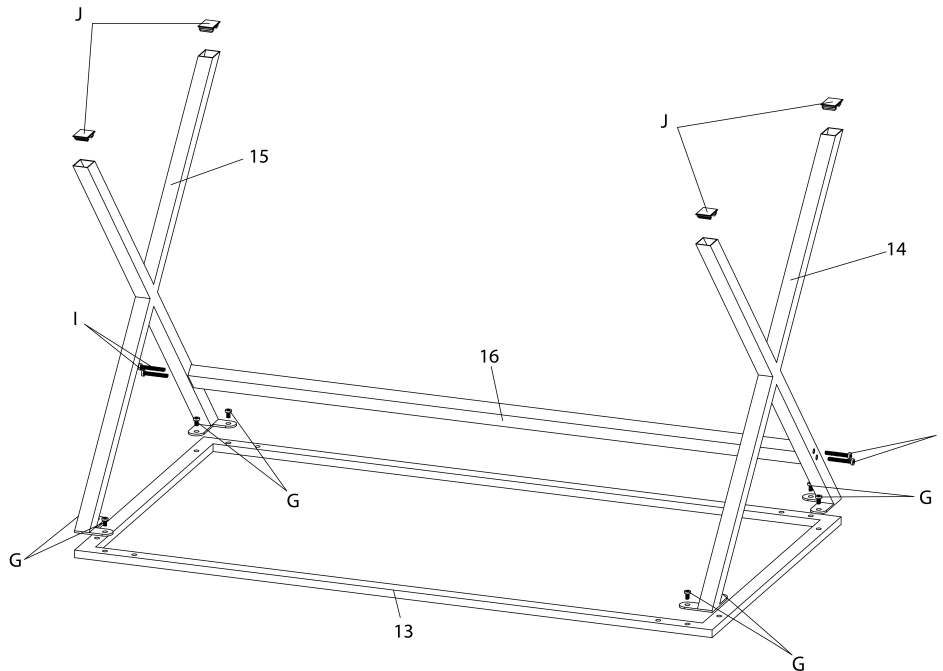

ÉTAPE / STEP 7

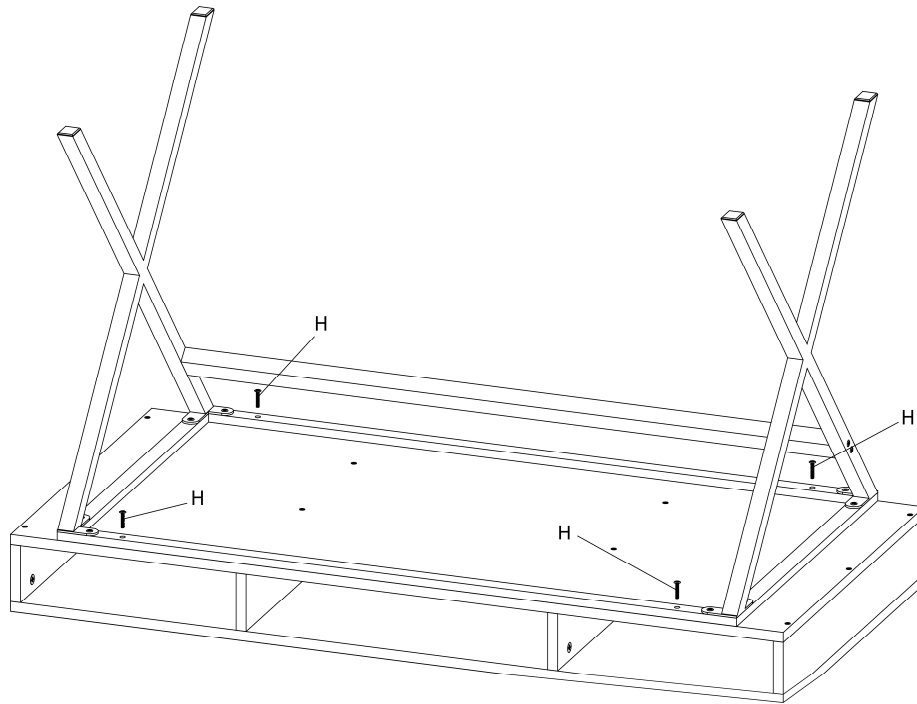

ÉTAPE / STEP 8

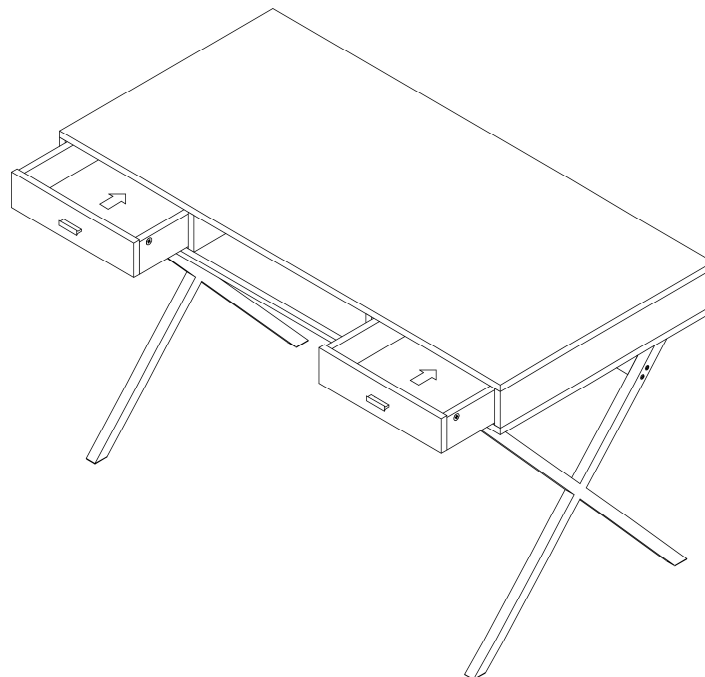

ÉTAPE / STEP 9

