



INSTRUCTIONS D'ASSEMBLAGE
ASSEMBLY INSTRUCTIONS

MONARCH
SPECIALTIES INC.

I 7443

ETAGERE -
60"H / FAUX BOIS TAUPE / VERRE TREMPE

BOOKCASE -
60"H / TAUPE RECLAIMED WOOD-LOOK / GLASS
PANELS



POUR DE L'ASSISTANCE OU POUR COMMANDER
DES PIÈCES CONTACTEZ NOTRE DÉPARTEMENT
DE SERVICE À LA CLIENTÈLE.

FOR ASSISTANCE OR TO ORDER PARTS
CONTACT OUR CUSTOMER SERVICE DEPARTMENT

WWW.MONARCHSERVICE.COM

LISTE DES PIÈCES
PARTS LIST

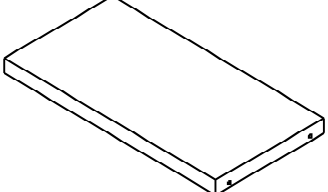
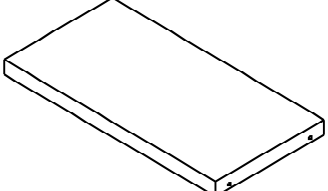
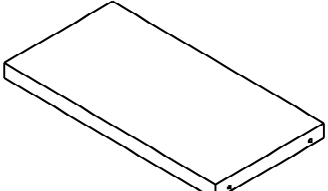
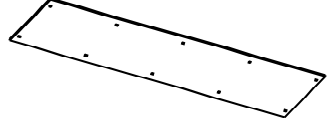
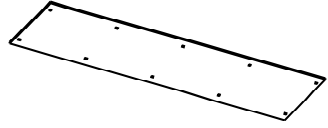
PIÈCE / PART #	IMAGE	DESCRIPTION	QTY / QTÉ
1		TOP SHELF ÉTAGÈRE SUPÉRIEURE	1
2		SHELF PANEL PANNEAU DE TABLETTE	3
3		BOTTOM SHELF ÉTAGÈRE DU BAS	1
4		FRONT FACING LEFT SIDE PANEL PANNEAU DE CÔTÉ GAUCHE	1
5		FRONT FACING RIGHT SIDE PANEL PANNEAU DE CÔTÉ AVANT DROIT	1

LISTE DES PIÈCES
PARTS LIST

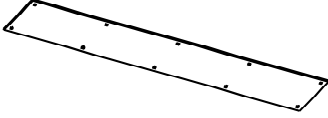
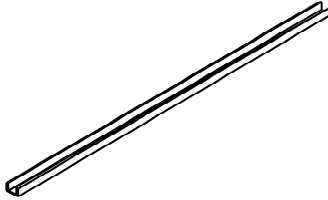
PIÈCE / PART #	IMAGE	DESCRIPTION	QTY / QTÉ
6		BACK PANEL PANNEAU ARRIÈRE	1
7		PLASTIC BAR BARRE DE PLASTIQUE	2

LISTE DES PIÈCES DE MONTAGE
HARDWARE LIST

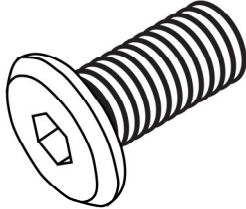
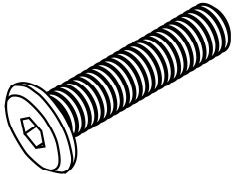
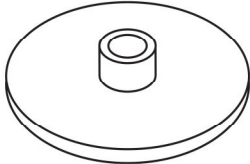
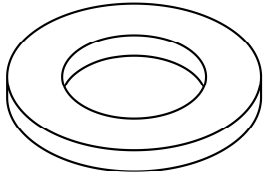
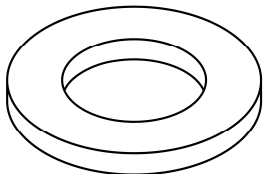
PIÈCE / PART #	IMAGE	DESCRIPTION	QTY / QTÉ
A		<p align="center">ASSEMBLING BOLT - Ø1/4" X 5/8"</p> <p align="center">BOULON D'ASSEMBLAGE - Ø1/4" X 5/8"</p>	10
B		<p align="center">ASSEMBLING BOLT - Ø1/4" X 1 7/8"</p> <p align="center">BOULON D'ASSEMBLAGE - Ø1/4" X 1 7/8"</p>	20
C		<p align="center">SCREW CAP - Ø1/4" X 1 3/8"</p> <p align="center">CAPUCHON DE VIS - Ø1/4" X 1 3/8"</p>	20
D		<p align="center">PLASTIC WASHER - Ø3/4"</p> <p align="center">RONDELLE DE PLASTIQUE - Ø3/4"</p>	10
E		<p align="center">PLASTIC WASHER - Ø1 1/4"</p> <p align="center">RONDELLE DE PLASTIQUE - Ø1 1/4"</p>	20

LISTE DES PIÈCES DE MONTAGE
HARDWARE LIST

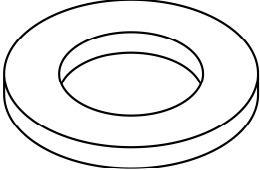
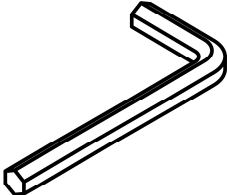
PIÈCE / PART #	IMAGE	DESCRIPTION	QTY / QTÉ
F		METAL WASHER - Ø3/4" RONDELLE DE MÉTAL - Ø3/4"	20
G		HEX KEY CLÉ HEXAGONALE	1



OUTIL DE VÉRIFICATION DE DIMENSIONS DES PIÈCES
HARDWARE DIMENSIONS VERIFICATION TOOL



ÉTAPE / STEP 1

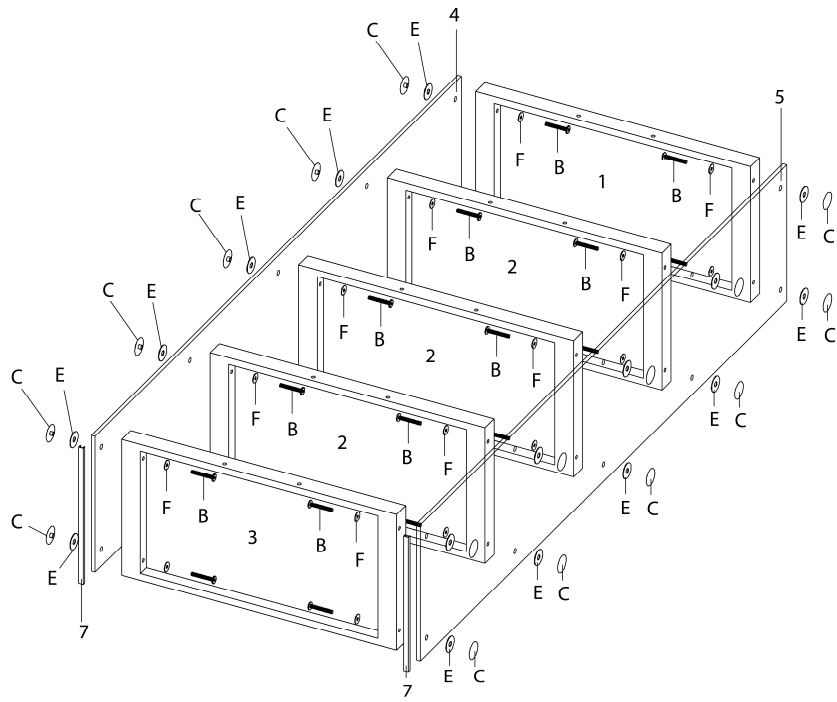

ÉTAPE / STEP 2

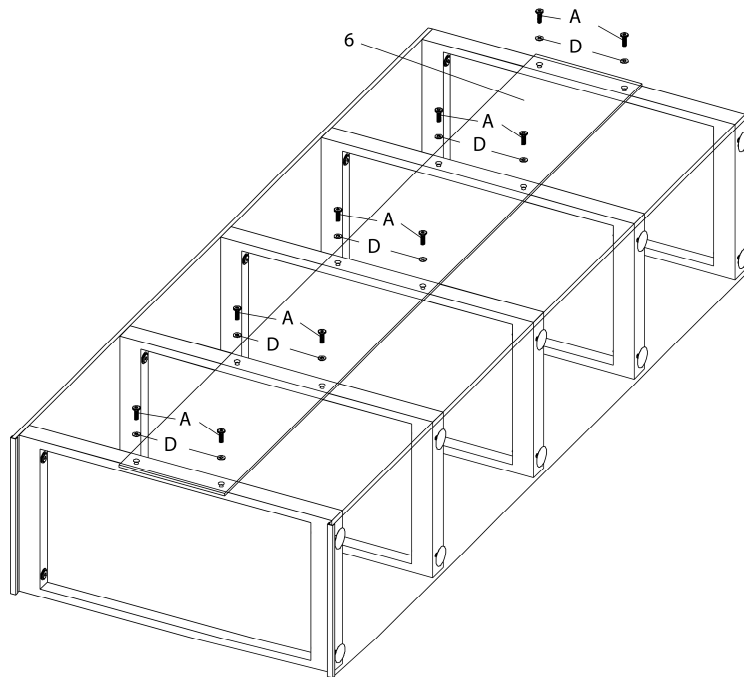

ÉTAPE / STEP 3

