

Features

- Four adjustable tempered glass shelves.
- Full-overlay mirrored door.
- Mirrors on back of door and interior back of cabinet.
- Two-way adjustable hinges with 107-degree opening capability for easy cabinet access.
- Can be installed with left- or right-hand swing
- Includes mounting hardware for surface or recessed installation.
- Multiple cabinets can be joined horizontally with ganging kit (sold separately).
- Requires K-2878 side mirror kit (sold separately) for surface mount installation.

Material

- Anodized aluminum construction with a durable rust- and chip-resistant finish.

Required Accessories

K-2878 Mirror Side Kit

Optional Accessories

K-2879 Ganging Hardware



Codes/Standards

None Applicable

KOHLER® One-Year Limited Warranty

See website for detailed warranty information.

Available Color/Finishes

Color tiles intended for reference only.

Color	Code	Description
-------	------	-------------

- | | | |
|--|-----|-------------------------|
|  | SAA | Satin Anodized Aluminum |
|--|-----|-------------------------|

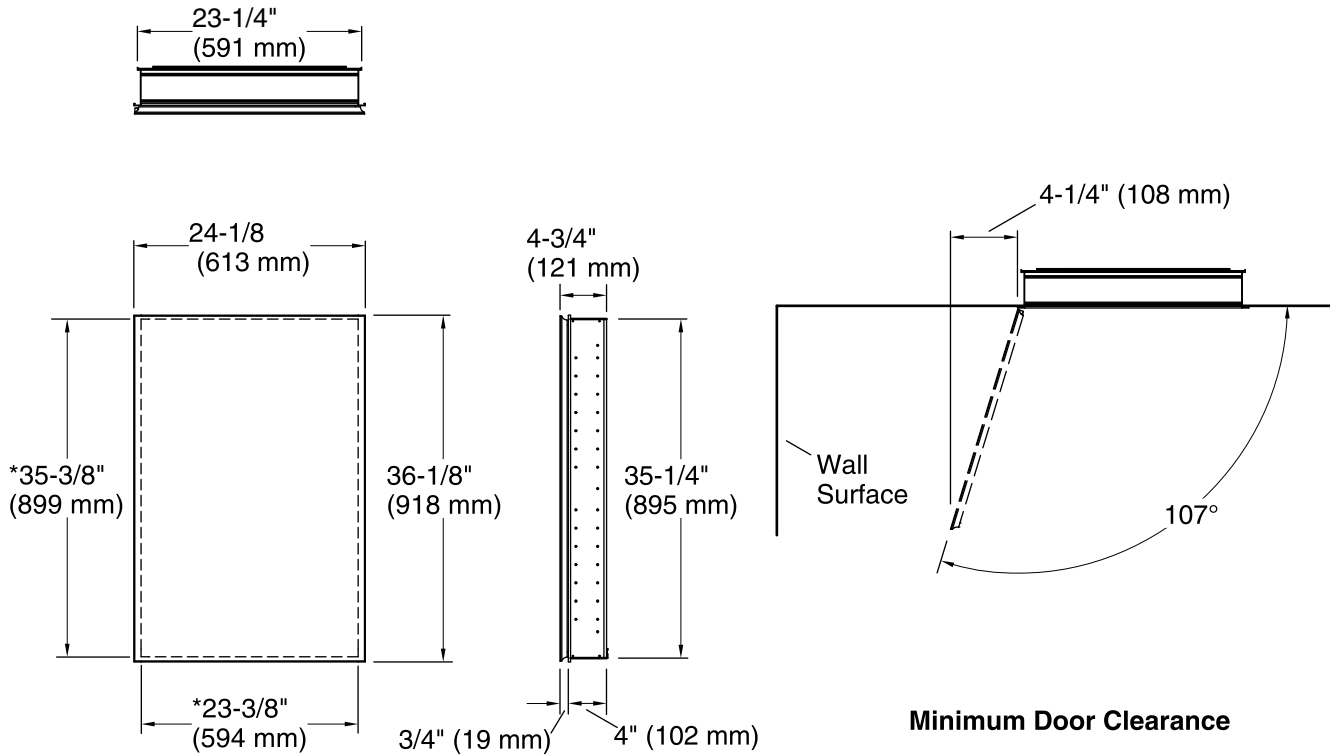

* Recess-Mount Cutout

Technical Information

All product dimensions are nominal.

Recess-Mount Cutout:

Width:	23-3/8" (594 mm)
Height:	35-3/8" (899 mm)
Depth:	4" (102 mm)

Notes

Install this product according to the installation guide.

When determining the height of the medicine cabinet, ensure the mirrored door will clear all obstacles (such as a faucet). A minimum distance of 3" (76 mm) is required.

To find the combined roughing-in width for joined cabinets, add the roughing-in width for each cabinet and add 1" (25 mm) for each ganging kit.

Secure the screws (provided) to a stud to avoid possible property and product damage. If this is not possible, anchors (not provided) must be inserted before installing the screws.

Roughing-in opening for recess-mount installations: 23-3/8" (594 mm) x 35-3/8" (899 mm) x 4" (102 mm).