

Specifications

Model	BTU	Watts	Width		Height		Depth		Viewing Area
			Actual	Framing	Actual	Framing	Actual	Framing	
NEFVC38H	5000	1500	16	*	38	*	5 5/8	*	26 x 15 1/4

* See "Recessed Installation" section for framing dimensions.

Dimensions

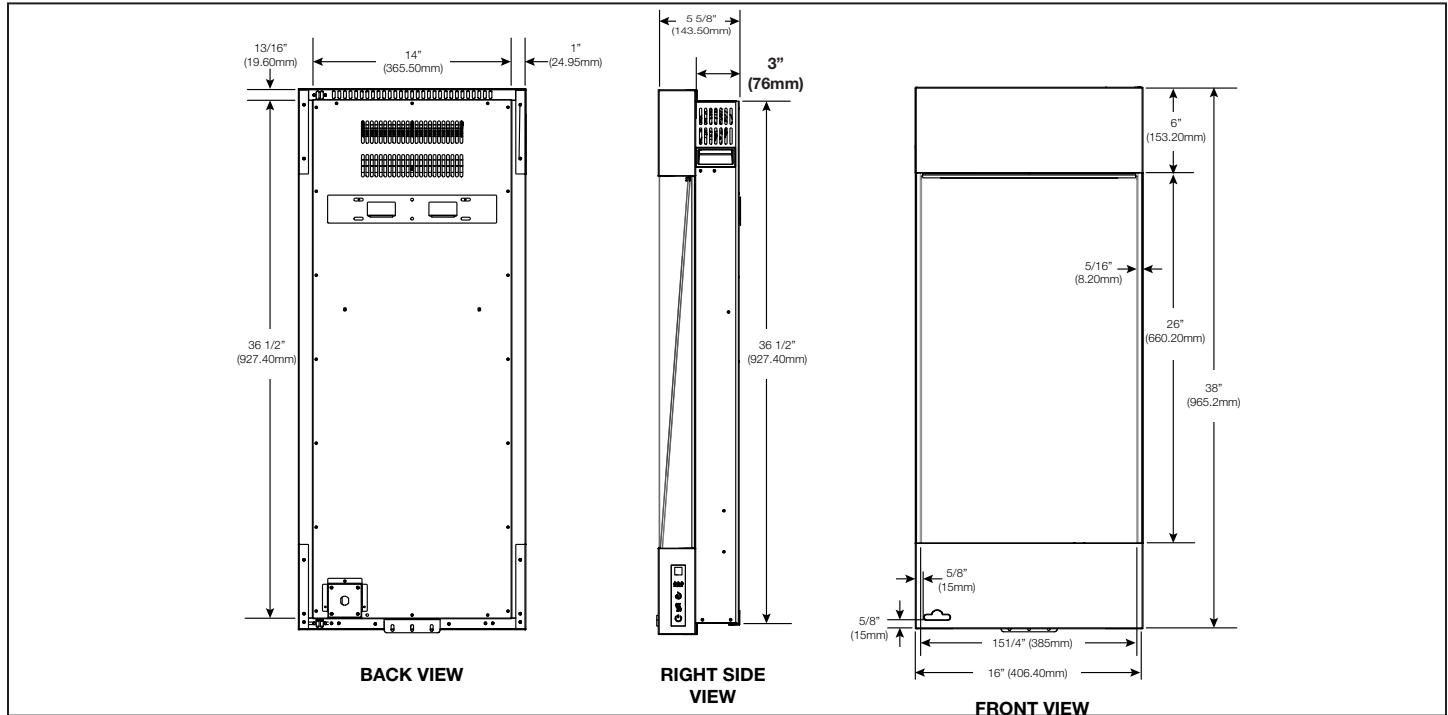

Minimum Mantel Clearances

⚠ WARNING

- When using paint or lacquer to finish the mantel, the paint or lacquer must be heat resistant to prevent discoloration.

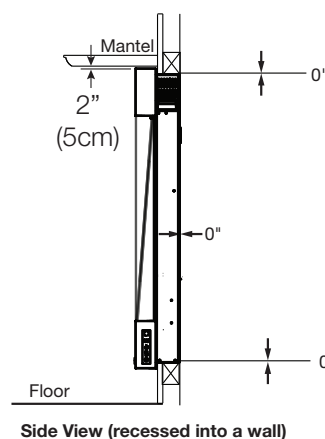
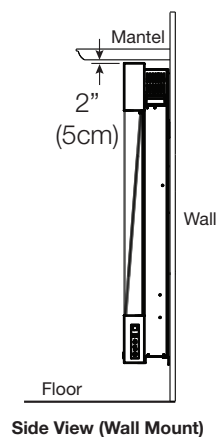

Product information provided is not complete and is subject to change without notice. Please consult the installation manual for the most up to date installation information.

Wall-Mount Installation

note:

We recommend having 2 people install this appliance.

1. Remove front glass (see "front glass removal and installation" section). If applicable, remove existing media.
2. Place appliance on a soft, non-abrasive surface then remove the side covers secured to the back of the appliance. Set aside.
3. Remove the bottom bracket (FIG. 1). Set aside.
4. Hold the appliance against the wall to determine its final location.
5. Using the appropriate wall mounting installation template (see manual), mark out the back and bottom bracket locations on the wall.

note:

The mounting brackets should be screwed into the wall studs with at least 2 screws. If the screws cannot be screwed into a stud, ensure that plastic anchors (provided) are used to affix the brackets to the wall and that the brackets are adequately secured.

6. Install the back bracket (shipped inside the styrofoam piece protecting the top of the appliance) using 2 drywall anchors and 2 wood screws (supplied). Ensure the bracket is levelled.

note:

The hooks on the back bracket must be facing upwards.

7. Install the bottom bracket using 2 drywall anchors and 2 wood screws (supplied).
8. Lift the appliance up until the two mounting slots clear the hooks on the back bracket. Slide appliance down until completely secured.
9. Secure the appliance to the bottom bracket using the screws previously removed in Step 3 (FIG. 2).
10. Install the front glass (see "front glass removal and installation" section).
11. Install the side covers using the 4 screws previously removed in Step 2 (FIG. 3).

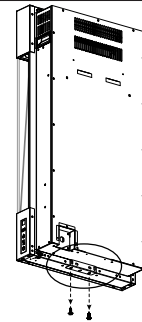

FIG. 1

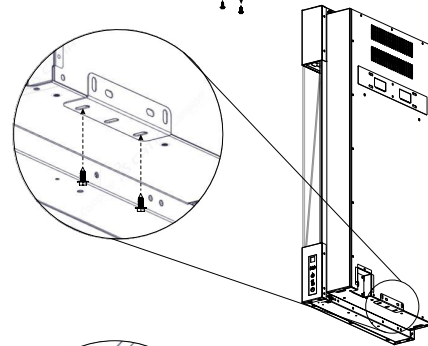

FIG. 2

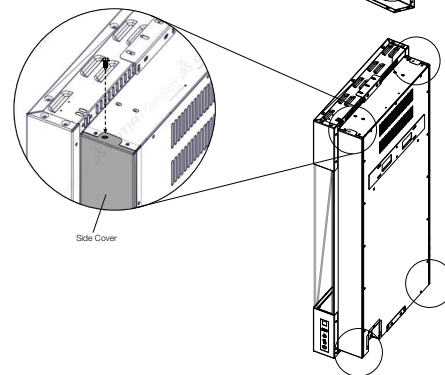
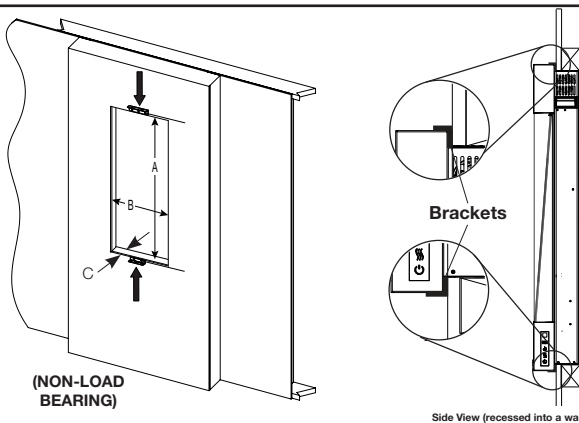

FIG. 3

Recessed Installation



FINISHING MATERIAL

Measurements from body of appliance:

Sides, Back, Top

0"

A	B	C
30 3/4" (78.1cm)	14 1/2" (36.8cm)	3 1/2" (8.9cm) min.

1. Remove the side covers secured to the back of the appliance and discard.
2. Insert the appliance into the recess, and then mark the top and bottom bracket locations. Remove the appliance from the recess and set aside on a soft, non-abrasive surface.
3. Remove the top and bottom brackets (FIG. 1).
4. Using the top and bottom bracket location markings from Step 2, install the top and bottom brackets to the wall using 4 wood screws (supplied).
5. Re-insert the appliance into the recess, and then secure it to the top and bottom brackets (FIG. 1).

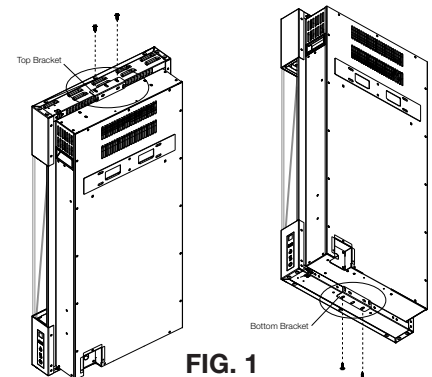

FIG. 1