



INSTRUCTIONS D'ASSEMBLAGE
ASSEMBLY INSTRUCTIONS

MONARCH
SPECIALTIES INC.

I 2007

PATERE -
70"H / METAL ARGENTE

COAT RACK -
70"H / SILVER METAL



**POUR DE L'ASSISTANCE OU POUR COMMANDER
DES PIÈCES CONTACTEZ NOTRE DÉPARTEMENT
DE SERVICE À LA CLIENTÈLE.**



**FOR ASSISTANCE OR TO ORDER PARTS
CONTACT OUR CUSTOMER SERVICE DEPARTMENT**

WWW.MONARCHSERVICE.COM

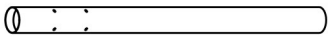
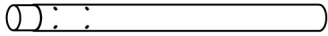
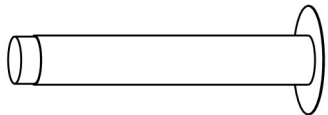
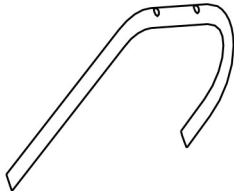
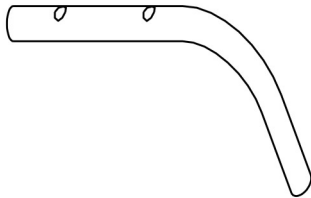

LISTE DES PIÈCES
PARTS LIST

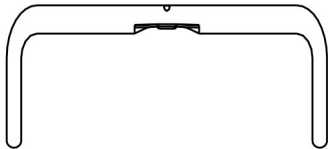
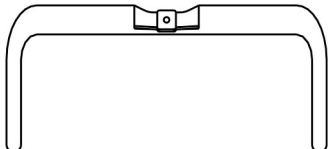
PIÈCE / PART #	IMAGE	DESCRIPTION	QTY / QTÉ
1		UPPER POST POTEAU SUPÉRIEUR	1
2		CENTER POST POTEAU DU CENTRE	1
3		BOTTOM POST POTEAU DU BAS	1
4		HOOK CROCHET	4
5		HOOK CROCHET	4

LISTE DES PIÈCES
PARTS LIST

PIÈCE / PART #	IMAGE	DESCRIPTION	QTY / QTÉ
6		<p>LEG PATTE</p>	1
7		<p>LEG PATTE</p>	1
8		<p>FINIAL FLEURON</p>	1
9		<p>FINIAL SUPPORT SUPPORT DE FLEURON</p>	1

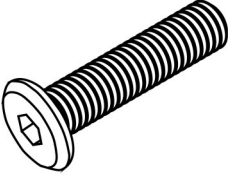
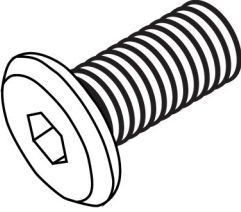
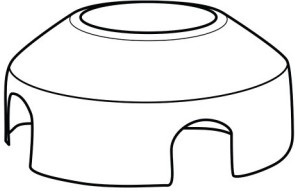
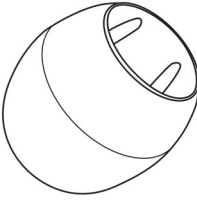
LISTE DES PIÈCES DE MONTAGE
HARDWARE LIST

PIÈCE / PART #	IMAGE	DESCRIPTION	QTY / QTÉ
A		ASSEMBLING BOLT - $\text{Ø } 3/8'' \text{ X } 1\ 1/2''$ BOULON D'ASSEMBLAGE - $\text{Ø } 3/8'' \text{ X } 1\ 1/2''$	1
B		ASSEMBLING BOLT - $\text{Ø } 1/4'' \text{ X } 3/4''$ BOULON D'ASSEMBLAGE - $\text{Ø } 1/4'' \text{ X } 3/4''$	16
C		SUPPORT - $\text{Ø } 3\ 3/8''$ SUPPORT - $\text{Ø } 3\ 3/8''$	1
D		CAP - $\text{Ø } 1/2''$ CAPUCHON - $\text{Ø } 1/2''$	12
E		CAP - $\text{Ø } 7/8''$ CAPUCHON - $\text{Ø } 7/8''$	4

LISTE DES PIÈCES DE MONTAGE
HARDWARE LIST

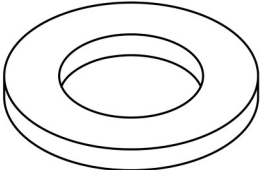
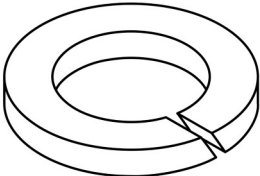
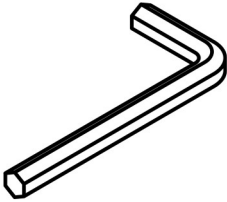
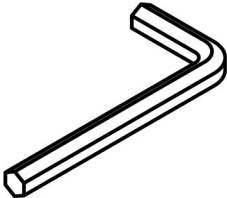
PIÈCE / PART #	IMAGE	DESCRIPTION	QTY / QTÉ
F		CAP - Ø 1/2" CAPUCHON - Ø 1/2"	4
G		METAL WASHER RONDELLE DE MÉTAL	1
H		LOCK WASHER ENTRETOISE DE MÉTAL	1
I		HEX KEY - M5 , 4M CLÉ HEXAGONALE - M5 , 4M	1
J		HEX KEY - M4 , 3M CLÉ HEXAGONALE - M4 , 3M	1



OUTIL DE VÉRIFICATION DE DIMENSIONS DES PIÈCES
HARDWARE DIMENSIONS VERIFICATION TOOL

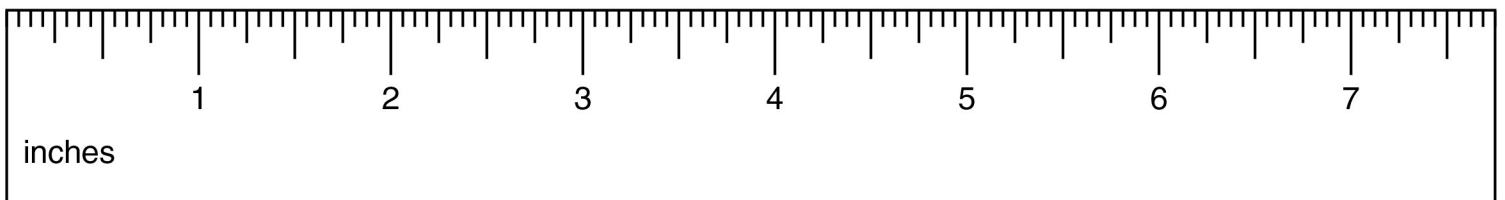

ÉTAPE / STEP 1

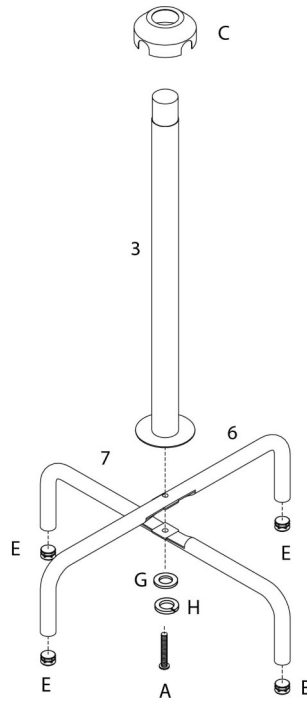

ÉTAPE / STEP 2

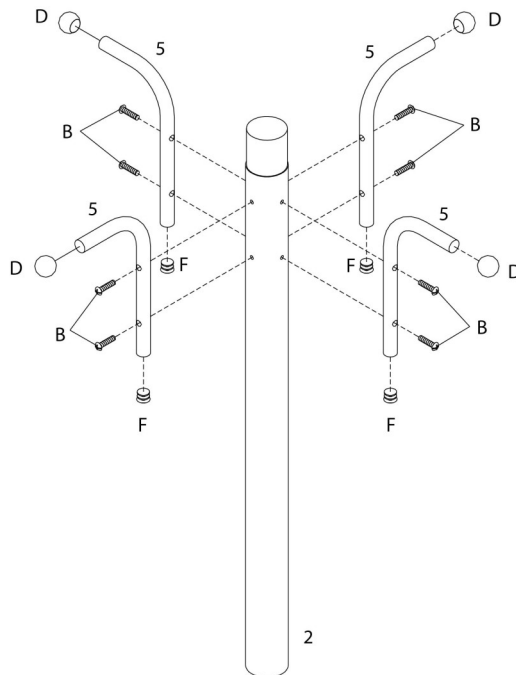

ÉTAPE / STEP 3

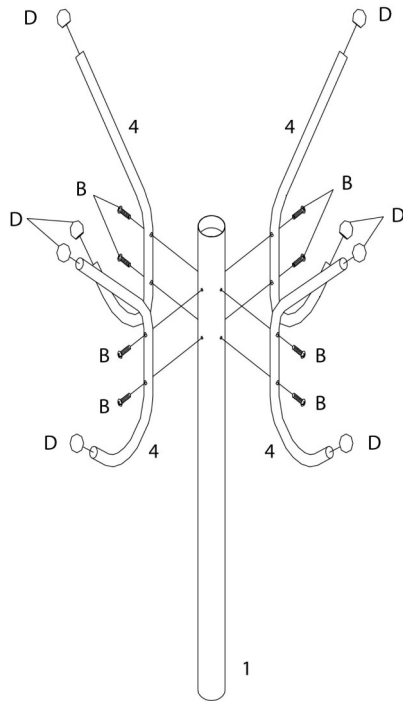

ÉTAPE / STEP 4

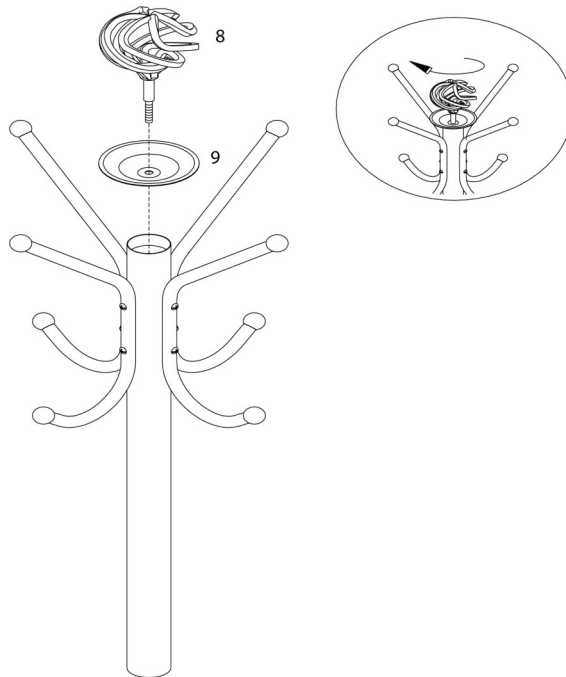

ÉTAPE / STEP 5

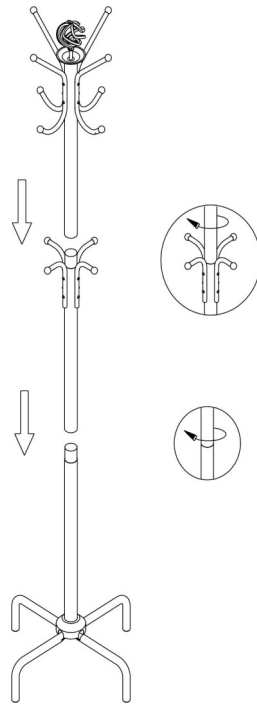

ÉTAPE / STEP 6

