



INSTRUCTIONS D'ASSEMBLAGE
ASSEMBLY INSTRUCTIONS

MONARCH
SPECIALTIES INC.

I 2310

BAR MAISON -
30"DIA / MARBRE CAPPUCCINO / METAL CAFE

HOME BAR -
30"DIA / CAPPUCCINO MARBLE / COFFEE METAL



**POUR DE L'ASSISTANCE OU POUR COMMANDER
DES PIÈCES CONTACTEZ NOTRE DÉPARTEMENT
DE SERVICE À LA CLIENTÈLE.**

**FOR ASSISTANCE OR TO ORDER PARTS
CONTACT OUR CUSTOMER SERVICE DEPARTMENT**

WWW.MONARCHSERVICE.COM

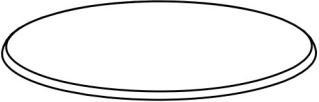
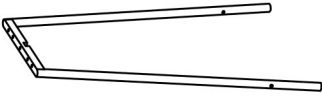
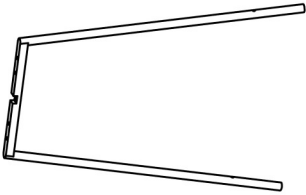
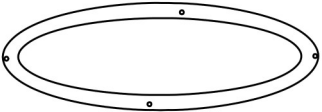
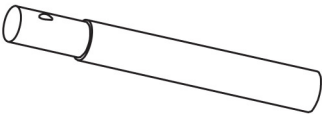

LISTE DES PIÈCES
PARTS LIST

PIÈCE / PART #	IMAGE	DESCRIPTION	QTY / QTÉ
1		BAR TOP SURFACE DU BAR	1
2		TABLE LEG PATTE DE TABLE	1
3		TABLE LEG PATTE DE TABLE	1
4		FOOT REST APPUI DU PIED	1
5		TABLE LEG FOR EXTENSION PATTE DE TABLE POUR EXTENSION	4

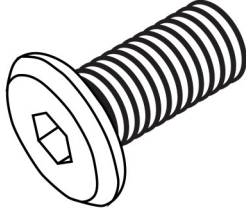
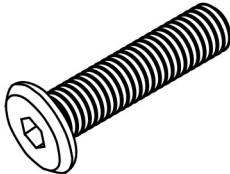
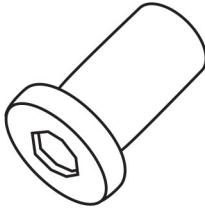
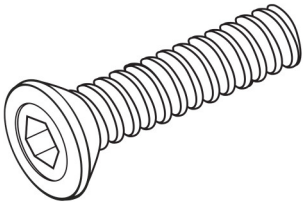
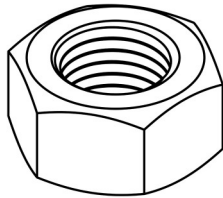
LISTE DES PIÈCES DE MONTAGE
HARDWARE LIST

PIÈCE / PART #	IMAGE	DESCRIPTION	QTY / QTÉ
A		ASSEMBLING BOLT - Ø 1/4" X 1/2" BOULON D'ASSEMBLAGE - Ø 1/4" X 1/2"	4
B		ASSEMBLING BOLT - Ø 1/4" X 1 1/8" BOULON D'ASSEMBLAGE - Ø 1/4" X 1 1/8"	12
C		BARREL NUT - Ø 1/4" X 3/4" ÉCROU DE CANON - Ø 1/4" X 3/4"	4
D		ASSEMBLING BOLT - Ø 1/4" X 1 1/8" BOULON D'ASSEMBLAGE - Ø 1/4" X 1 1/8"	1
E		HEX NUT - Ø 1/4" ÉCROU HEXAGONALE - Ø 1/4"	1

LISTE DES PIÈCES DE MONTAGE
HARDWARE LIST

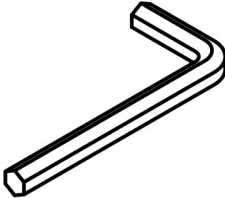
PIÈCE / PART #	IMAGE	DESCRIPTION	QTY / QTÉ
F		<p align="center">CAP - Ø 1" CAPUCHON - Ø 1"</p>	4
G		<p align="center">SPANNER CLÉ ANGLAISE</p>	1
H		<p align="center">HEX KEY CLÉ HEXAGONALE</p>	1



OUTIL DE VÉRIFICATION DE DIMENSIONS DES PIÈCES
HARDWARE DIMENSIONS VERIFICATION TOOL



ÉTAPE / STEP 1

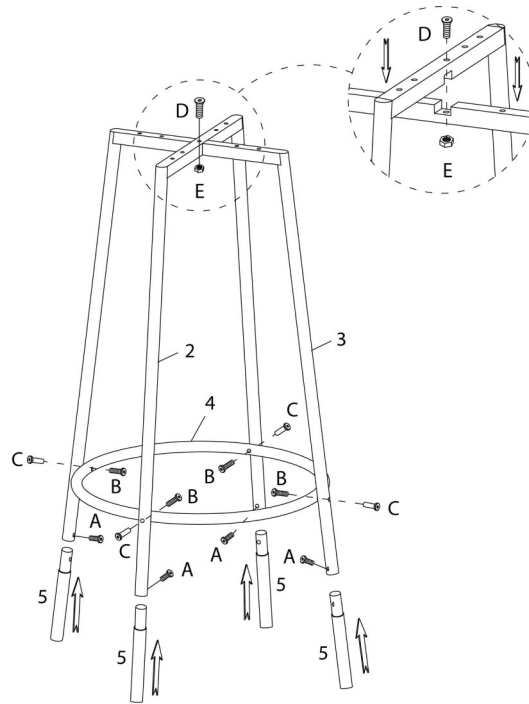

ÉTAPE / STEP 2

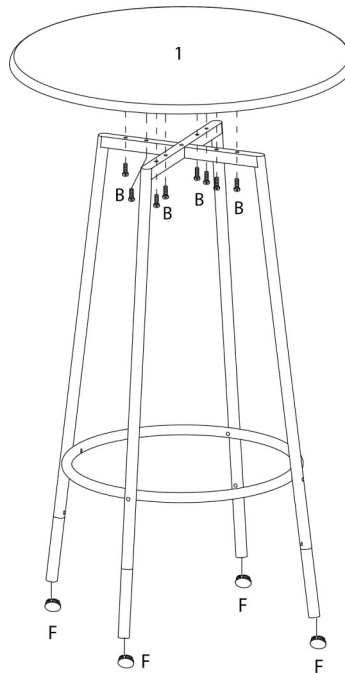

ÉTAPE / STEP 3

