



**INSTRUCTIONS D'ASSEMBLAGE**  
**ASSEMBLY INSTRUCTIONS**

---

**M**ONARCH  
SPECIALTIES INC.

# I 2376

---

**BAR MAISON -**  
**24"X 36" / DESSUS BLANC ET METAL**

**HOME BAR -**  
**24"X 36" / WHITE TOP AND METAL SPACESAVER**



**POUR DE L'ASSISTANCE OU POUR COMMANDER  
DES PIÈCES CONTACTEZ NOTRE DÉPARTEMENT  
DE SERVICE À LA CLIENTÈLE.**

**FOR ASSISTANCE OR TO ORDER PARTS  
CONTACT OUR CUSTOMER SERVICE DEPARTMENT**

**WWW.MONARCHSERVICE.COM**

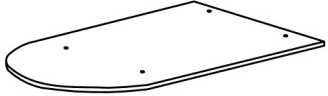
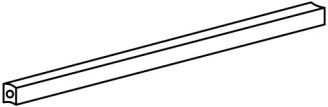
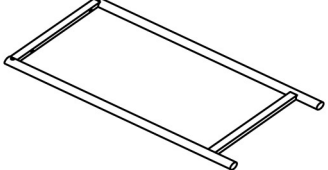
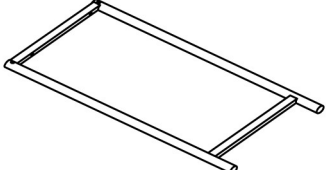
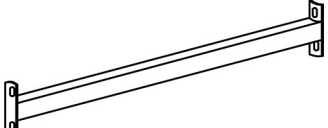

**LISTE DES PIÈCES**  
**PARTS LIST**

PIÈCE / PART #	IMAGE	DESCRIPTION	QTY / QTÉ
1		<p align="center"><b>BAR TOP</b> <b>SURFACE DU BAR</b></p>	1
2		<p align="center"><b>SUPPORT BAR</b> <b>BARRE DE SOUTIEN</b></p>	2
3		<p align="center"><b>SIDE FRAME</b> <b>CADRE DE CÔTÉ</b></p>	1
4		<p align="center"><b>SIDE FRAME</b> <b>CADRE DE CÔTÉ</b></p>	1
5		<p align="center"><b>CROSSBAR</b> <b>BARRE TRANSVERSALE</b></p>	2

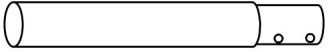
**LISTE DES PIÈCES**  
**PARTS LIST**

PIÈCE / PART #	IMAGE	DESCRIPTION	QTY / QTÉ
6		TABLE LEG FOR EXTENSION PATTE DE TABLE POUR EXTENSION	4

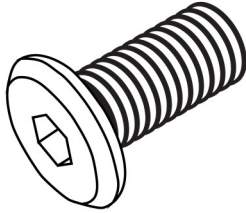
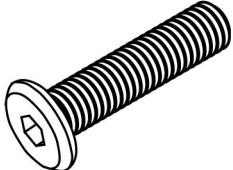
**LISTE DES PIÈCES DE MONTAGE**  
**HARDWARE LIST**

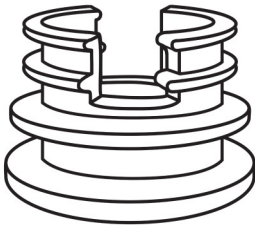
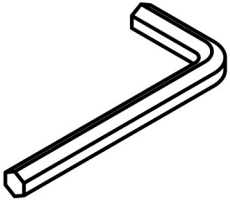
PIÈCE / PART #	IMAGE	DESCRIPTION	QTY / QTÉ
<b>A</b>		<b>ASSEMBLING BOLT -</b> <b>Ø 1/4" X 3/4"</b> <b>BOULON D'ASSEMBLAGE -</b> <b>Ø 1/4" X 3/4"</b>	<b>16</b>
<b>B</b>		<b>ASSEMBLING BOLT -</b> <b>Ø 1/4" X 1 3/4"</b> <b>BOULON D'ASSEMBLAGE -</b> <b>Ø 1/4" X 1 3/4"</b>	<b>4</b>
<b>C</b>		<b>ASSEMBLING BOLT -</b> <b>Ø 1/4" X 1 1/8"</b> <b>BOULON D'ASSEMBLAGE -</b> <b>Ø 1/4" X 1 1/8"</b>	<b>4</b>
<b>D</b>		<b>FLOOR PROTECTOR -</b> <b>Ø 1"</b> <b>PROTECTEUR DE PLANCHER -</b> <b>Ø 1"</b>	<b>4</b>
<b>E</b>		<b>HEX KEY</b> <b>CLÉ HEXAGONALE</b>	<b>1</b>

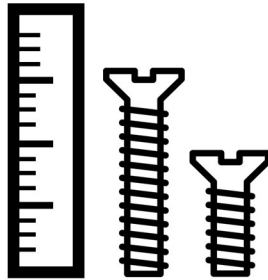

OUTIL DE VÉRIFICATION DE DIMENSIONS DES PIÈCES  
HARDWARE DIMENSIONS VERIFICATION TOOL

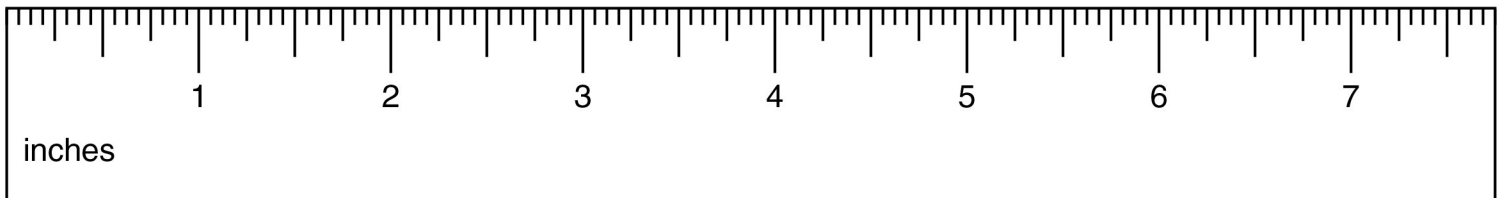

ÉTAPE / STEP 1

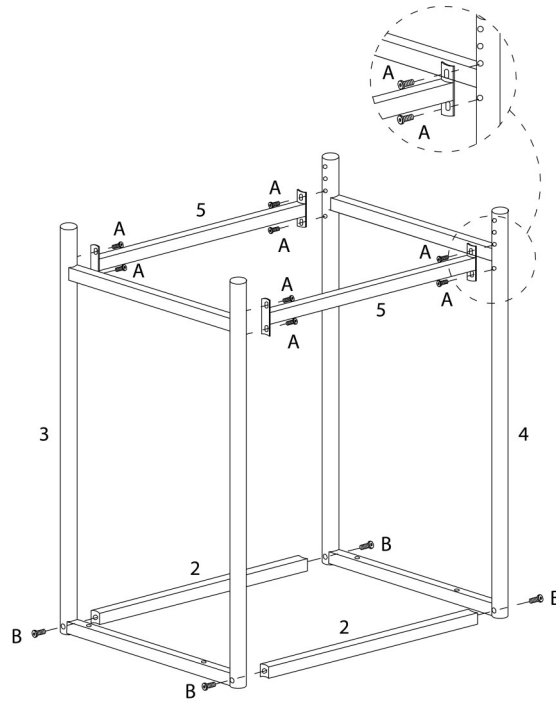

ÉTAPE / STEP 2

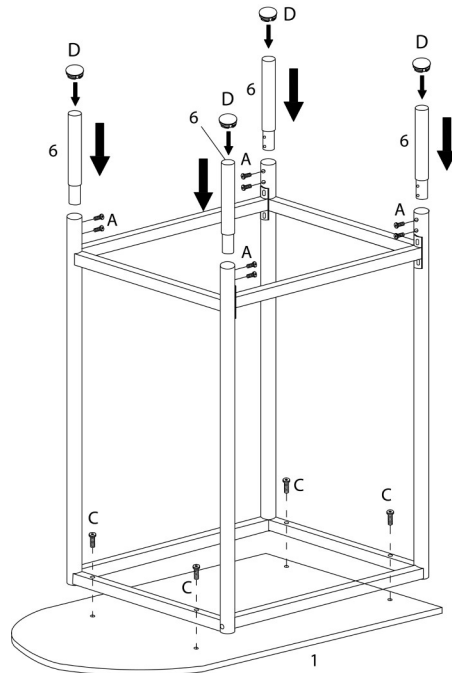

ÉTAPE / STEP 3

