



INSTRUCTIONS D'ASSEMBLAGE
ASSEMBLY INSTRUCTIONS

MONARCH
SPECIALTIES INC.

I 7250

CHAISE DE BUREAU -
GRIS MICRO-FIBRE / DOSSIER EXECUTIF

OFFICE CHAIR -
GREY MICROFIBER / HIGH BACK EXECUTIVE





POUR DE L'ASSISTANCE OU POUR COMMANDER
DES PIÈCES CONTACTEZ NOTRE DÉPARTEMENT
DE SERVICE À LA CLIENTÈLE.

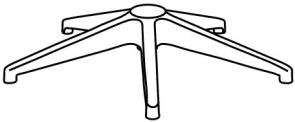

FOR ASSISTANCE OR TO ORDER PARTS
CONTACT OUR CUSTOMER SERVICE DEPARTMENT

WWW.MONARCHSERVICE.COM

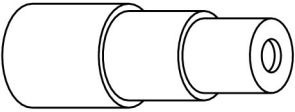
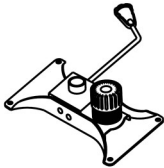
LISTE DES PIÈCES
PARTS LIST

PIÈCE / PART #	IMAGE	DESCRIPTION	QTY / QTÉ
1		CASTOR ROULLETTE	5
2		BASE BASE	1
3		GASLIFT ASCENSEUR À ESSENCE	1
4		TELESCOPIC COLUMN COVER COUVERTURE DE COLONNE TÉLÉSCOPIQUE	1
5		CHAIR MECHANISM SEAT PLATE MÉCANISME DE SIÈGE	1

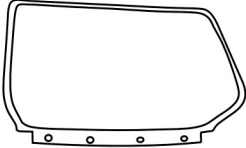
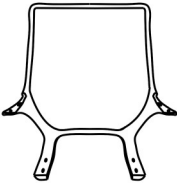
LISTE DES PIÈCES
PARTS LIST

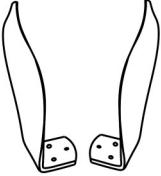
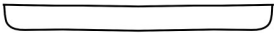
PIÈCE / PART #	IMAGE	DESCRIPTION	QTY / QTÉ
6		<p align="center">BACK REST DOSSIER</p>	1
7		<p align="center">BACK DOSSIER</p>	1
8		<p align="center">SEAT CUSHION COUSSIN DU SIÈGE</p>	1
9		<p align="center">ARM REST ACCOUDOIR</p>	2
10		<p align="center">SCREW CAP CAPUCHON DE VIS</p>	1

LISTE DES PIÈCES DE MONTAGE
HARDWARE LIST

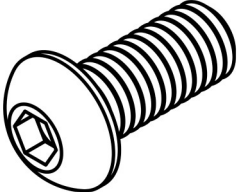
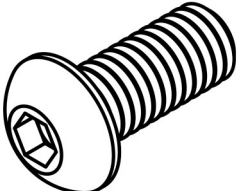
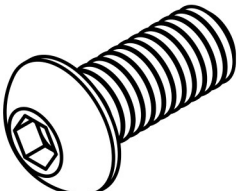
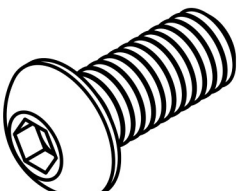
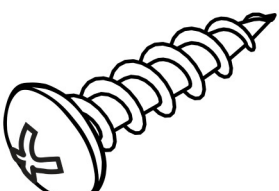
PIÈCE / PART #	IMAGE	DESCRIPTION	QTY / QTÉ
A		<p align="center">ASSEMBLING BOLT - Ø 1/4" X 3/4"</p> <p align="center">BOULON D'ASSEMBLAGE - Ø 1/4" X 3/4"</p>	4
B		<p align="center">ASSEMBLING BOLT - Ø 1/4" X 1"</p> <p align="center">BOULON D'ASSEMBLAGE - Ø 1/4" X 1"</p>	6
C		<p align="center">ASSEMBLING BOLT - Ø 1/4" X 1 3/8"</p> <p align="center">BOULON D'ASSEMBLAGE - Ø 1/4" X 1 3/8"</p>	4
D		<p align="center">ASSEMBLING BOLT - Ø 1/4" X 5/8"</p> <p align="center">BOULON D'ASSEMBLAGE - Ø 1/4" X 5/8"</p>	4
E		<p align="center">ASSEMBLING SCREW - Ø 1/4" X 3/4"</p> <p align="center">VIS D'ASSEMBLAGE - Ø 1/4" X 3/4"</p>	4

LISTE DES PIÈCES DE MONTAGE
HARDWARE LIST

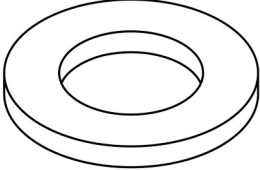
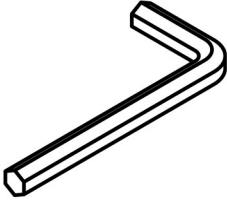
PIÈCE / PART #	IMAGE	DESCRIPTION	QTY / QTÉ
F		METAL WASHER RONDELLE DE MÉTAL	10
G		HEX KEY CLÉ HEXAGONALE	1

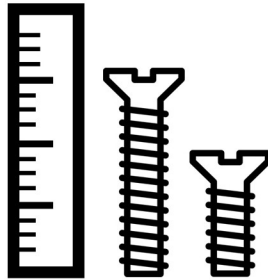

OUTIL DE VÉRIFICATION DE DIMENSIONS DES PIÈCES
HARDWARE DIMENSIONS VERIFICATION TOOL

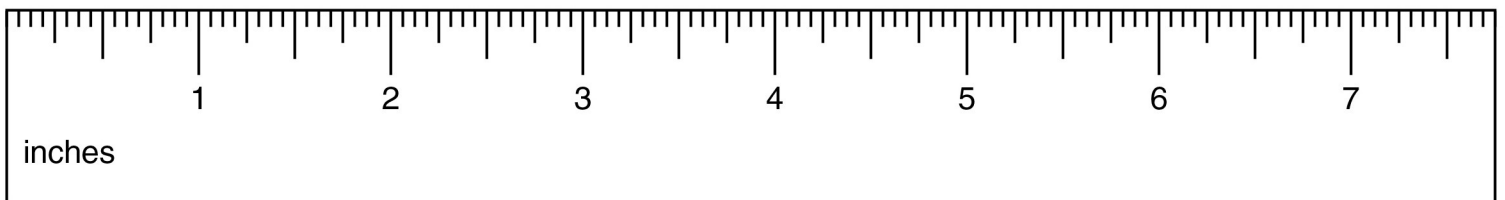

ÉTAPE / STEP 1

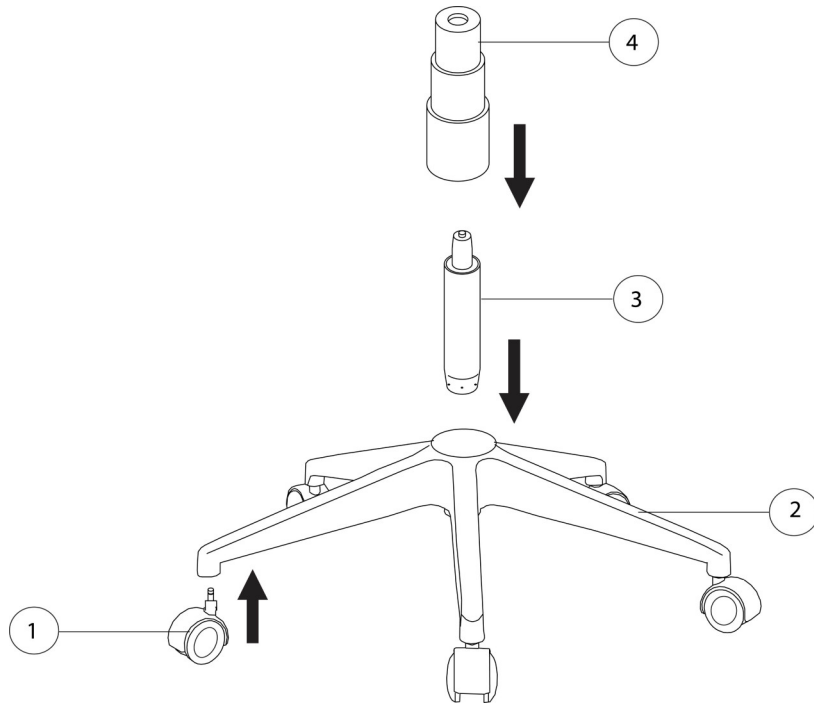

ÉTAPE / STEP 2

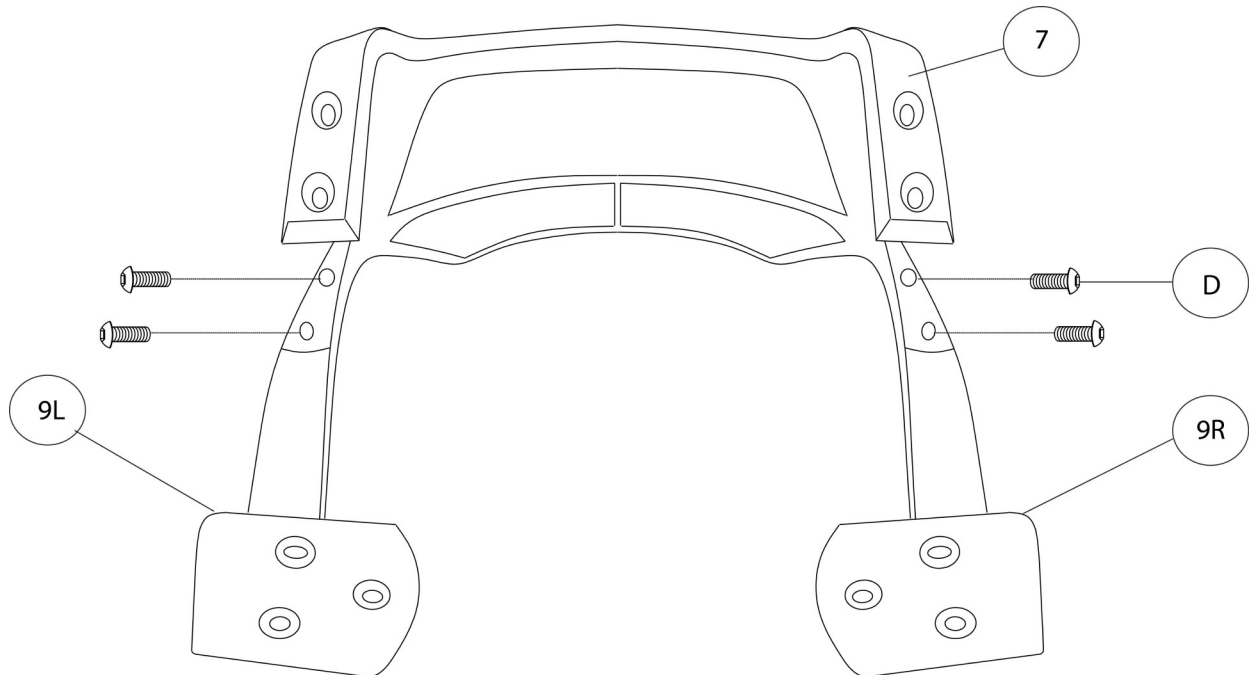

ÉTAPE / STEP 3

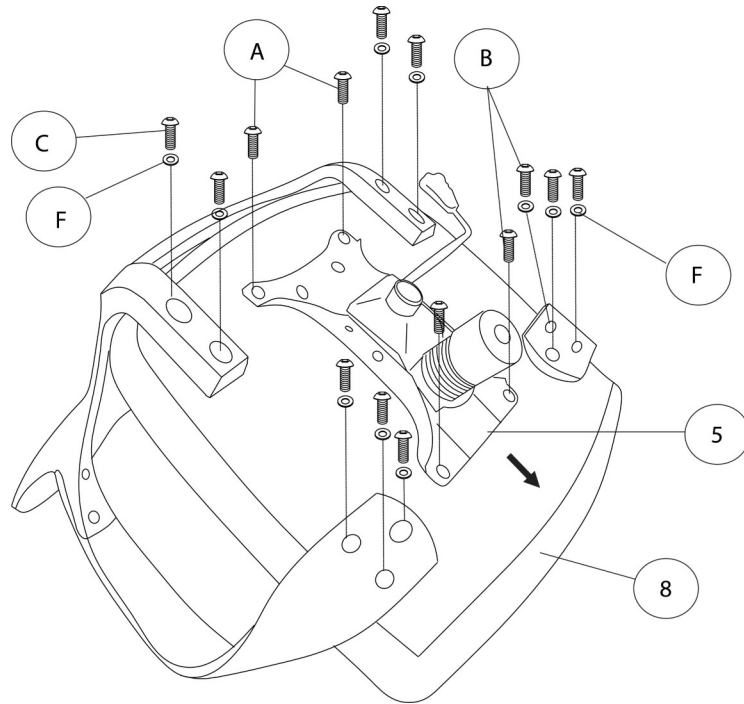

ÉTAPE / STEP 4

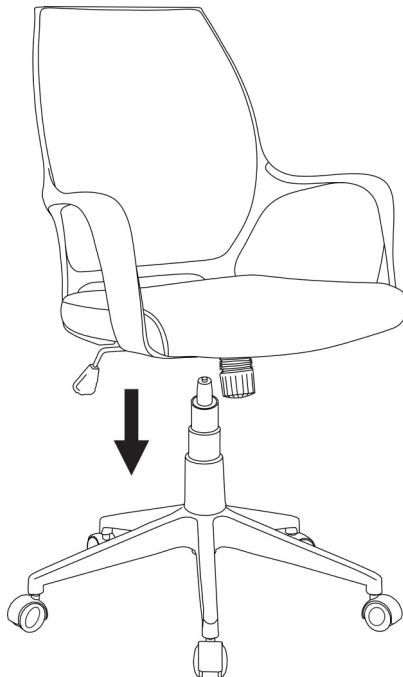

ÉTAPE / STEP 5

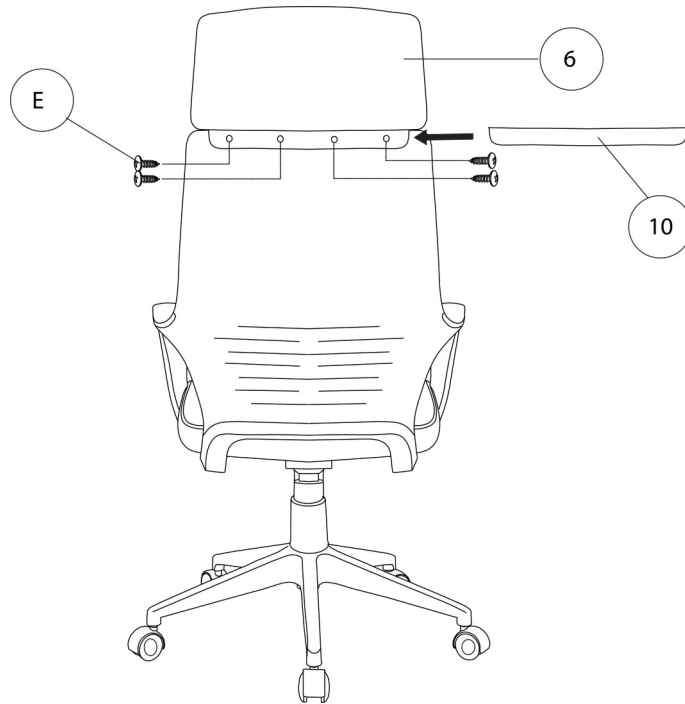

ÉTAPE / STEP 6

