



INSTRUCTIONS D'ASSEMBLAGE
ASSEMBLY INSTRUCTIONS

MONARCH
SPECIALTIES INC.

I 7110

BUREAU -
30"L / JUVENILE BLANC / METAL BLANC

COMPUTER DESK -
30"L / JUVENILE WHITE / WHITE METAL



**POUR DE L'ASSISTANCE OU POUR COMMANDER
DES PIÈCES CONTACTEZ NOTRE DÉPARTEMENT
DE SERVICE À LA CLIENTÈLE.**

**FOR ASSISTANCE OR TO ORDER PARTS
CONTACT OUR CUSTOMER SERVICE DEPARTMENT**

WWW.MONARCHSERVICE.COM

LISTE DES PIÈCES
PARTS LIST

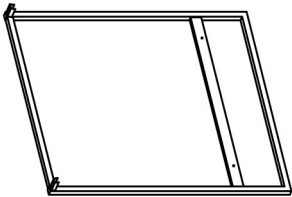
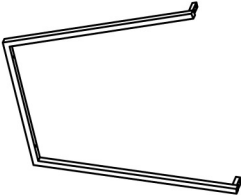
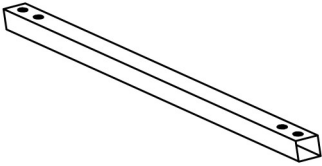
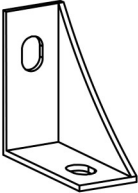
PIÈCE / PART #	IMAGE	DESCRIPTION	QTY / QTÉ
1		TABLE TOP SURFACE DE TABLE	1
2		FRAME CADRE	1
3		FRAME CADRE	1
4		SUPPORT BAR BARRE DE SOUTIEN	2
5		CONNECTOR CONNECTEUR	4

LISTE DES PIÈCES DE MONTAGE
HARDWARE LIST

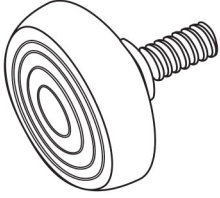
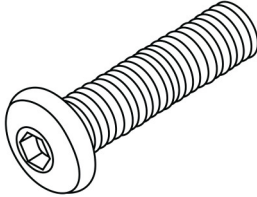
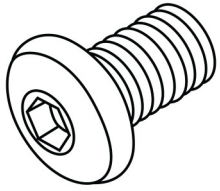
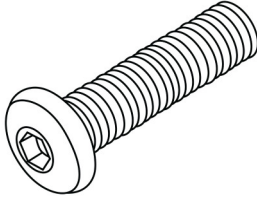
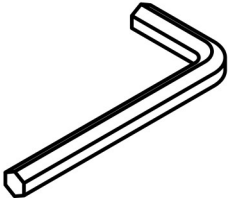
PIÈCE / PART #	IMAGE	DESCRIPTION	QTY / QTÉ
A		ADJUSTABLE LEG - Ø 1/4" X 3/4" PATTE AJUSTABLE - Ø 1/4" X 3/4"	4
B		ASSEMBLING BOLT - Ø 1/4" X 1 7/8" BOULON D'ASSEMBLAGE - Ø 1/4" X 1 7/8"	2
C		ASSEMBLING BOLT - Ø 1/4" X 1/2" BOULON D'ASSEMBLAGE - Ø 1/4" X 1/2"	16
D		ASSEMBLING BOLT - Ø 1/4" X 1 1/8" BOULON D'ASSEMBLAGE - Ø 1/4" X 1 1/8"	2
E		HEX KEY CLÉ HEXAGONALE	1

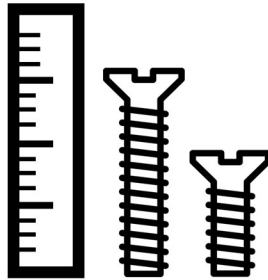

OUTIL DE VÉRIFICATION DE DIMENSIONS DES PIÈCES
HARDWARE DIMENSIONS VERIFICATION TOOL

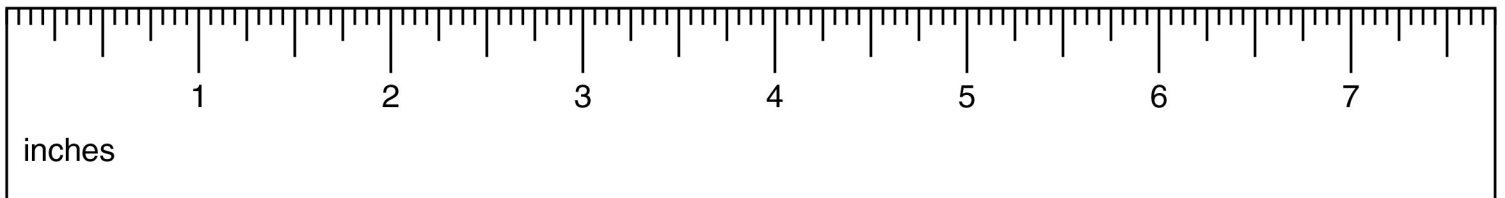

ÉTAPE / STEP 1

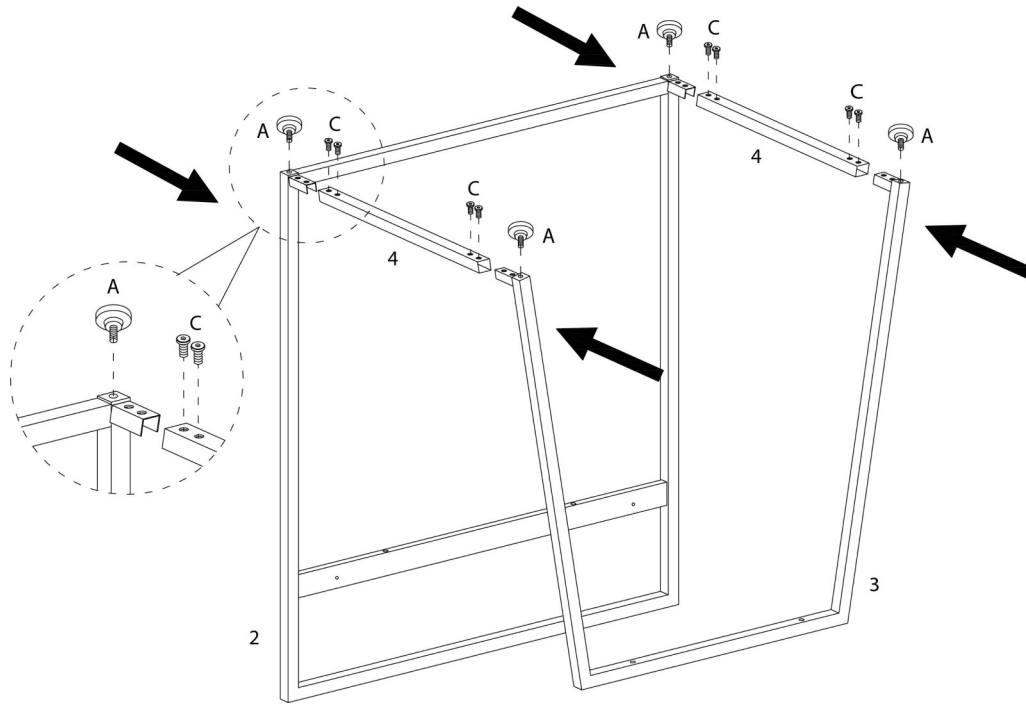

ÉTAPE / STEP 2

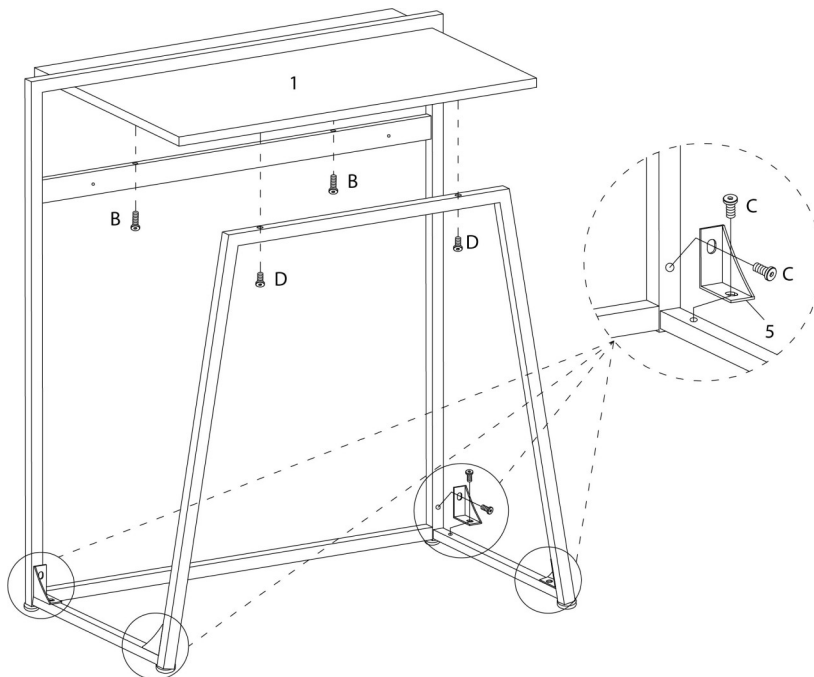

ÉTAPE / STEP 3

