



INSTRUCTIONS D'ASSEMBLAGE
ASSEMBLY INSTRUCTIONS

MONARCH
SPECIALTIES INC.

I 7261

CHAISE DE BUREAU -
MECHE BLANC JUVENILE / MULTI-POSITION

OFFICE CHAIR -
WHITE MESH JUVENILE / MULTI-POSITION



POUR DE L'ASSISTANCE OU POUR COMMANDER
DES PIÈCES CONTACTEZ NOTRE DÉPARTEMENT
DE SERVICE À LA CLIENTÈLE.



FOR ASSISTANCE OR TO ORDER PARTS
CONTACT OUR CUSTOMER SERVICE DEPARTMENT

WWW.MONARCHSERVICE.COM

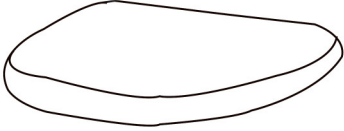
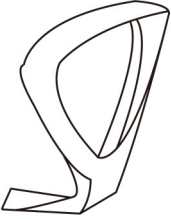
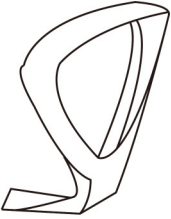
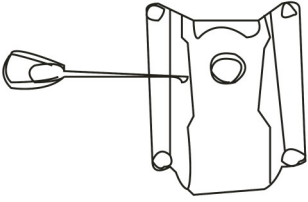
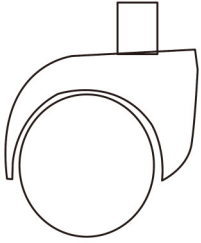
LISTE DES PIÈCES
PARTS LIST

PIÈCE / PART #	IMAGE	DESCRIPTION	QTY / QTÉ
1		CHAIR SEAT SIÈGE	1
2		FRONT FACING LEFT ARMREST ACCOUDOIR AVANT GAUCHE	1
3		FRONT FACING RIGHT ARMREST ACCOUDOIR AVANT DROIT	1
4		CHAIR MECHANISM SEAT PLATE MÉCANISME DE SIÈGE	1
5		CASTOR ROULLETTE	5

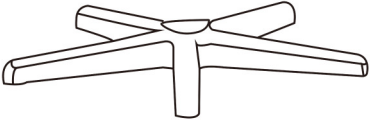
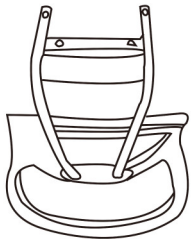
LISTE DES PIÈCES
PARTS LIST

PIÈCE / PART #	IMAGE	DESCRIPTION	QTY / QTÉ
6		GASLIFT ASCENSEUR À ESSENCE	1
7		BASE BASE	1
8		BACK REST DOSSIER	1
9		TELESCOPIC COLUMN COVER COUVERTURE DE COLONNE TÉLÉSCOPIQUE	1

LISTE DES PIÈCES DE MONTAGE
HARDWARE LIST

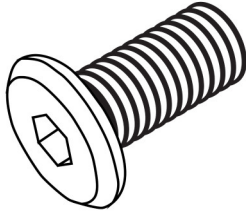
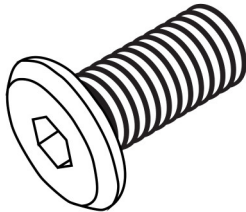
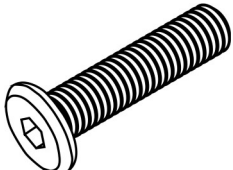
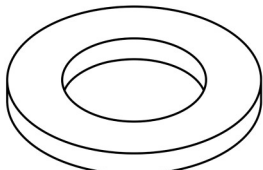
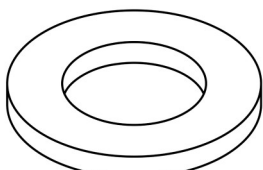
PIÈCE / PART #	IMAGE	DESCRIPTION	QTY / QTÉ
A		<p align="center">ASSEMBLING BOLT - Ø 1/4" X 1"</p> <p align="center">BOULON D'ASSEMBLAGE - Ø 1/4" X 1"</p>	6
B		<p align="center">ASSEMBLING BOLT - Ø 1/4" X 3/4"</p> <p align="center">BOULON D'ASSEMBLAGE - Ø 1/4" X 3/4"</p>	6
C		<p align="center">ASSEMBLING BOLT - Ø 1/4" X 1 1/8"</p> <p align="center">BOULON D'ASSEMBLAGE - Ø 1/4" X 1 1/8"</p>	2
D		<p align="center">METAL WASHER - Ø 1/4" X 3/4"</p> <p align="center">RONDELLE DE MÉTAL - Ø 1/4" X 3/4"</p>	8
E		<p align="center">METAL WASHER - Ø 1/4" X 5/8"</p> <p align="center">RONDELLE DE MÉTAL - Ø 1/4" X 5/8"</p>	6

LISTE DES PIÈCES DE MONTAGE
HARDWARE LIST

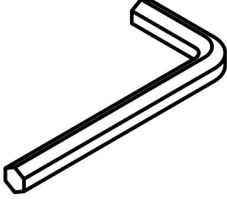
PIÈCE / PART #	IMAGE	DESCRIPTION	QTY / QTÉ
F		HEX KEY CLÉ HEXAGONALE	1



OUTIL DE VÉRIFICATION DE DIMENSIONS DES PIÈCES
HARDWARE DIMENSIONS VERIFICATION TOOL

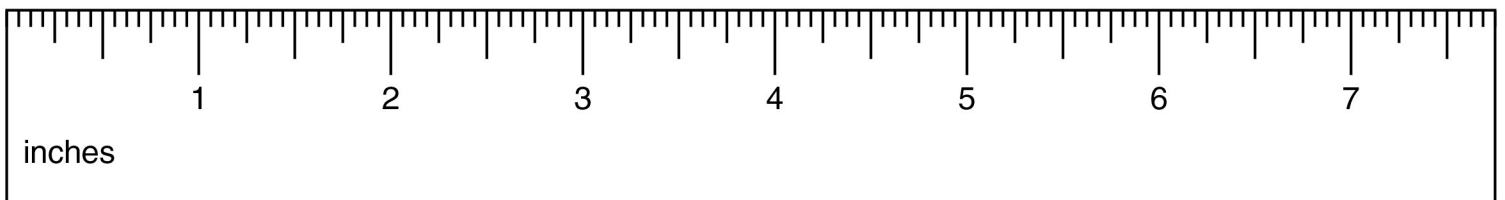

ÉTAPE / STEP 1

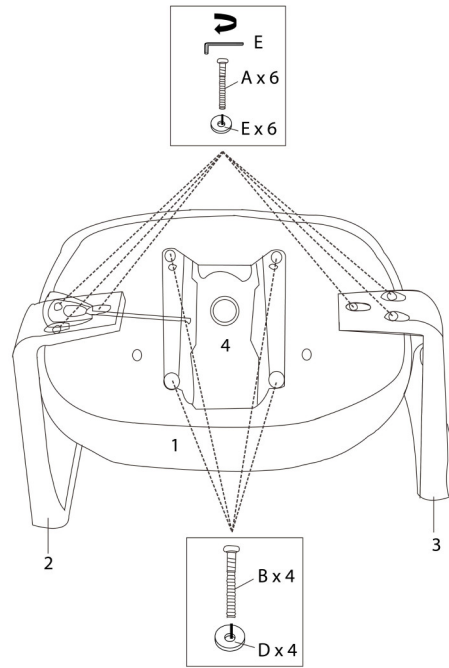

ÉTAPE / STEP 2

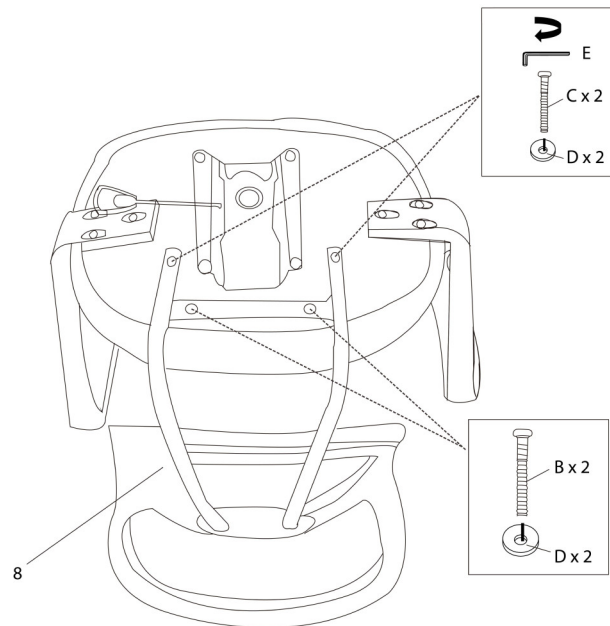

ÉTAPE / STEP 3

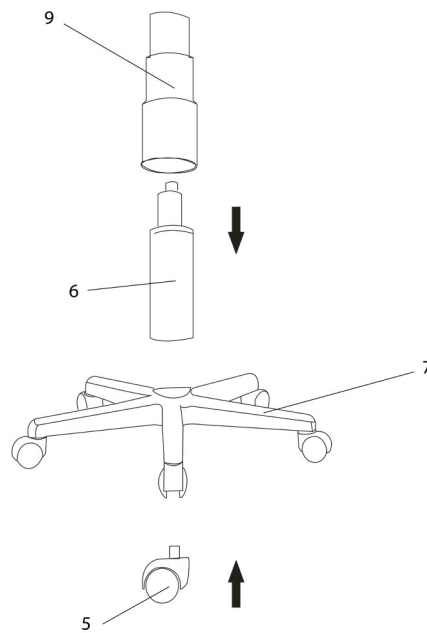

ÉTAPE / STEP 4

