

Seoul gazebo 10' x 14' B101424 (2019) Assembly Instructions

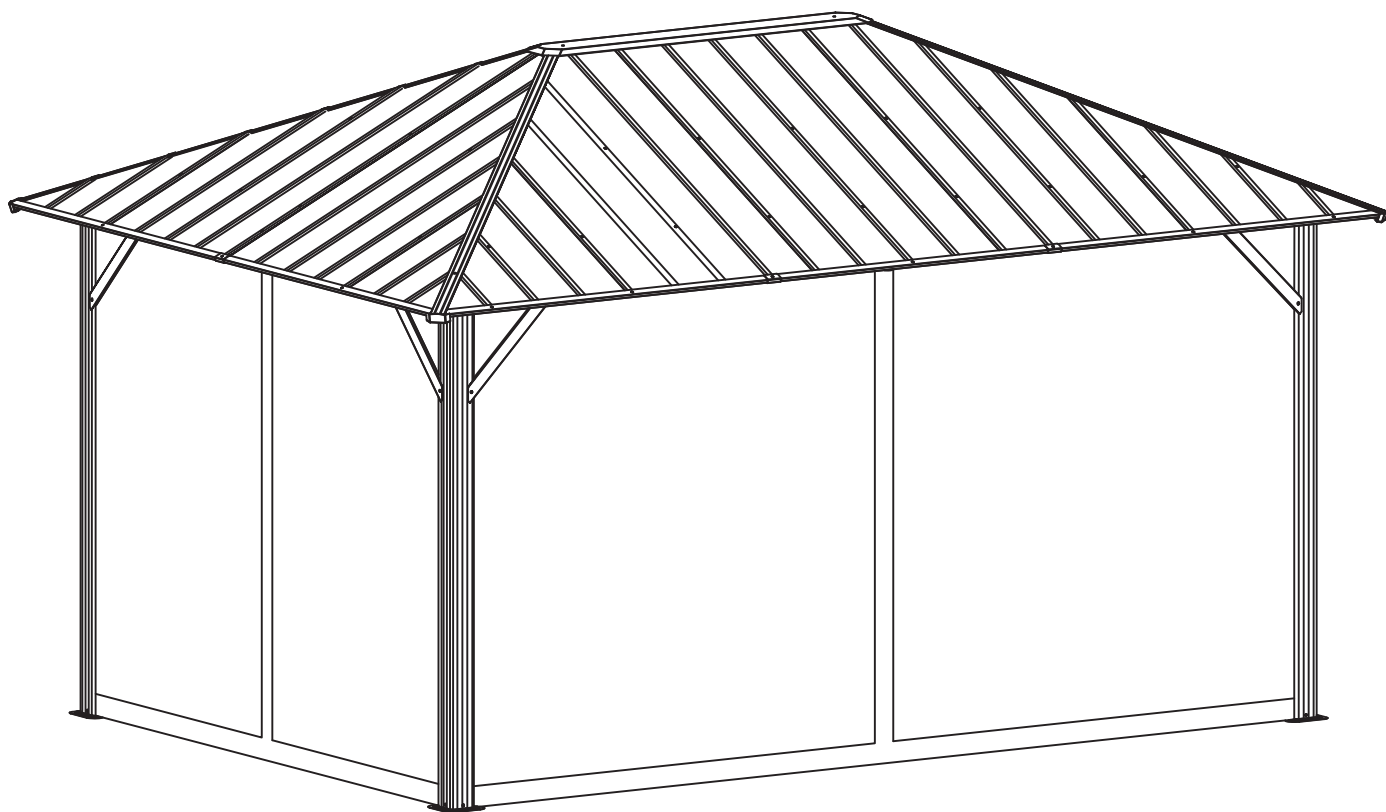

MEUBLES DE JARDIN
CORRIVEAU
OUTDOOR FURNITURE

IMPORTANT:

Please read and follow all safety statements, warnings, assembly instructions, use & care directions before attempting to assemble. Each of the recommendations must be followed to ensure the utmost solidity.

Security Rules

Warning:

Keep flame and heat sources away from the gazebo fabric. The fabric may burn if it is exposed to prolonged contact with a source of heat. The application of any foreign substance to the gazebo fabric may render the flame-resistant properties ineffective.

Regulation

It is the responsibility of the consumer being in accordance with city regulation, construction code, zoning or any limitations and obtaining permit prior assembling gazebo.

Recommendation

- When assembling and using this product, basic safety precautions should always be followed to reduce the risk of personal injury and damage to parts.
- Do not use the gazebo during extreme weather conditions.
- Before beginning assembly of product, make sure all parts are present. Compare parts with package contents list. If any part is missing or damaged, do not attempt to assemble the product.
- Some parts may contain sharp edges. Use of protective gloves is always recommended.
- When installing and assembling your gazebo, it is recommended that 2 or more adults are involved.
- Considering at least five hours to complete installation, even well anchored, a gazebo unit that is not finished assembly can get or create damages to nearby environment.
- Verify that all nuts and bolts are tightly secured before and during use.
- Use proper tools and equipment for a safe and compliant installation. Never climb, sit or stand on structure while assembling.
- Even if this gazebo is built for all year round, the snow must be removed from the roof at all time.
- Mosquito net and curtains (optional) must be removed from the unit in freezing period.
- Anchoring bolts or other anchoring devices are not supplied.
- Keep away from any electric installation or transportation device.
- Always recommended to keep assembly manual for further reference.

Care

Avoid using a pressure washer. The use of a mild soap with warm water is the best solution for the frame only. A clear water rinse is necessary then. Never use soap on fabric, this will reduce their durability, consequently their lifespan and general look. The use of a soft brush and warm water are an excellent solution for cleaning the fabric.

Warranty

Covered

We warrant the frame and fabric to be free of manufacturing defects to the original purchaser for one year.

Not covered

This warranty does not cover commercial use, improper care, neglected storage, vandalism, chemical, acts of nature, fire, oxidation, stains, freeze damage, improper packaging for return and unreasonable or abusive use. Normal discoloration and build-up snow are not covered either.

Customer service:

Consumer







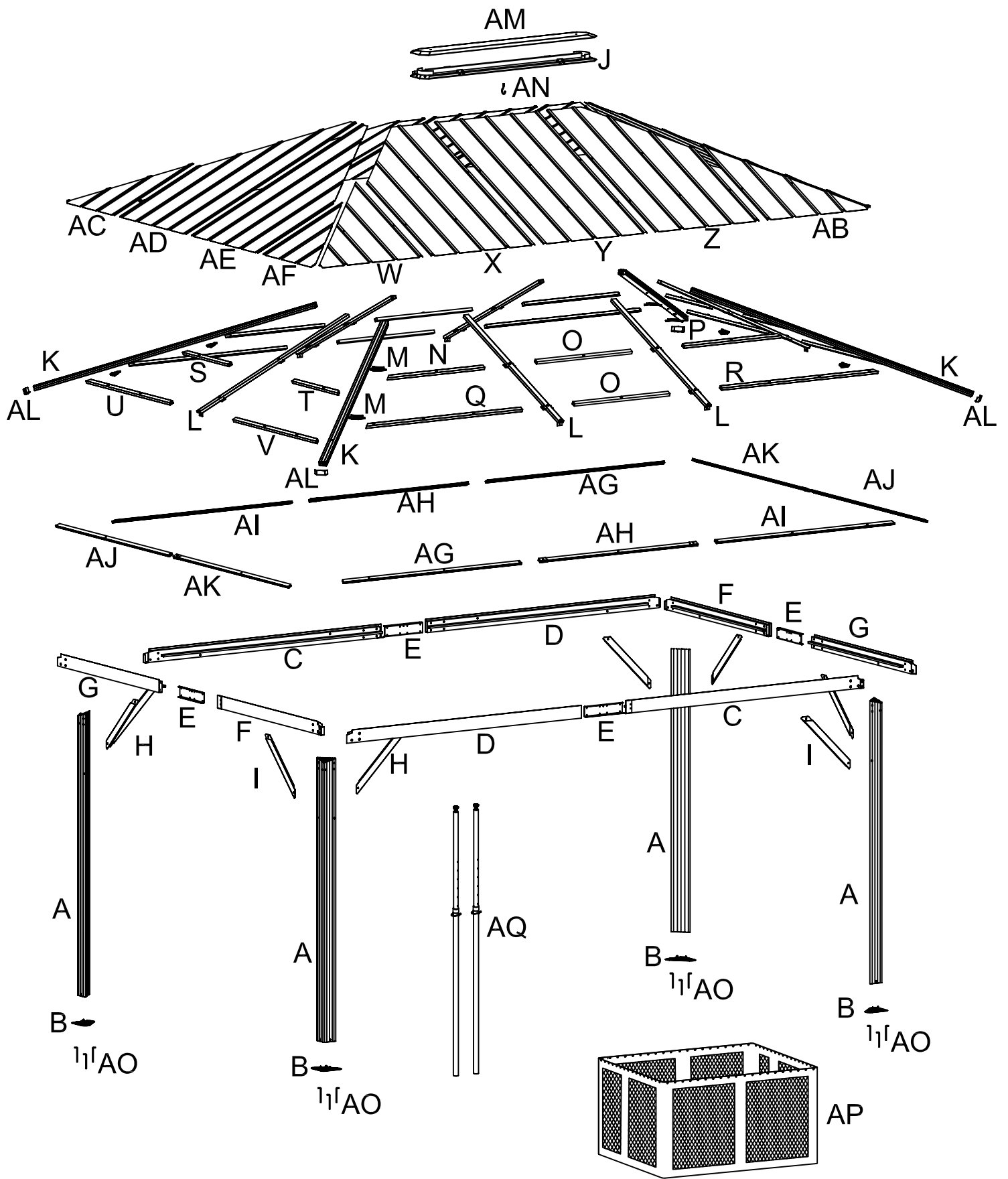

For each part request, please contact your retailer with a description of the problem, pictures and consumer invoice copy, to ensure the proper information to be proceed.



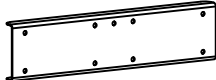

Seller

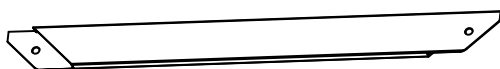
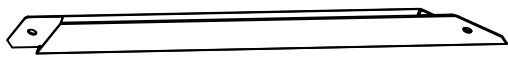



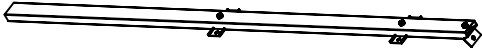
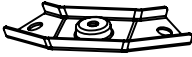
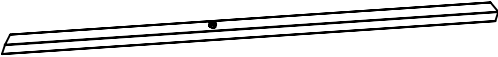
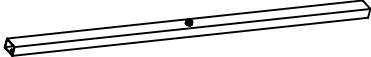
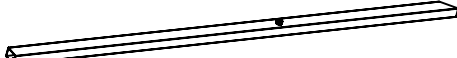

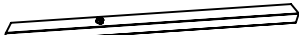
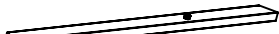
In addition to all the information already provided by the consumer, any parts requested must mention the person responsible for the client's file, the retailer name, address, branch if applicable, e-mail address, fax and phone number.



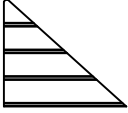
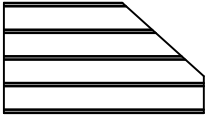
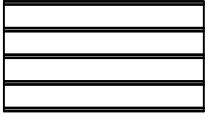

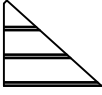

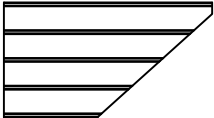
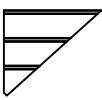
PARTS LIST:





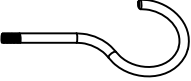
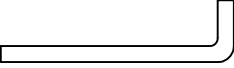
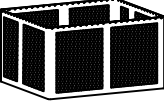
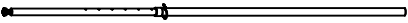

No.	Description	Drawing	Qty
A	Post		4
B	Base flange		4
C	Long crossbar		2
D	Long crossbar		2
E	Connector		4
F	Short crossbar		2
G	Short crossbar		2
H	Right brace		4
I	Left brace		4
J	Roof connector		1
K	Corner roof tube		4

No.	Description	Drawing	Qty
L	Roof support tube		6
M	Corner connector		8
N	Roof support tube for 14' side		2
O	Roof support tube for 14' side		4
P	Roof support tube for 14' side		2
Q	Roof support tube for 14' side		2
R	Roof support tube for 14' side		2
S	Roof support tube for 10' side		2
T	Roof support tube for 10' side		2
U	Roof support tube for 10' side		2
V	Roof support tube for 10' side		2

No.	Description	Drawing	Qty
W	Left roof panel for 14' side		2
X	Left roof panel for 14' side		2
Y	Middle roof panel for 14' side		2
Z	Right roof panel for 14' side		2
AB	Right roof panel for 14' side		2
AC	Left roof panel for 10' side		2
AD	Left roof panel for 10' side		2
AE	Right roof panel for 10' side		2
AF	Right roof panel for 10' side		2
AG	Eave profile		2
AH	Eave profile		2

No.	Description	Drawing	Qty
AI	Eave profile		2
AJ	Eave profile		2
AK	Eave profile		2
AL	Corner connector		4
AM	Roof cap		1
AN	Hook		1
AO	Stake		12
AP	Mosquito net		1
AQ	Winter post		2

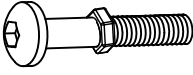
Hardware Kit:

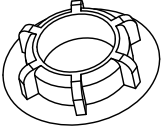
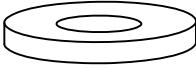
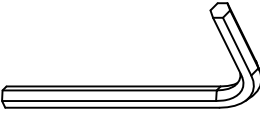
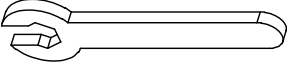
No.	Description	Drawing	Qty
AA	Bolt M6 X 15mm		178
BB	Bolt M6 X 20mm		20
CC	Bolt M6 X 30mm		2
DD	Bolt M6 X 50mm		4
EE	Half-thread screw M6 X 30mm		24
FF	M6 Nut		20
GG	Plastic cap		24
HH	Plastic washer		72
II	Allen key		2
JJ	Spanner		1

A  x 4

B  x 4

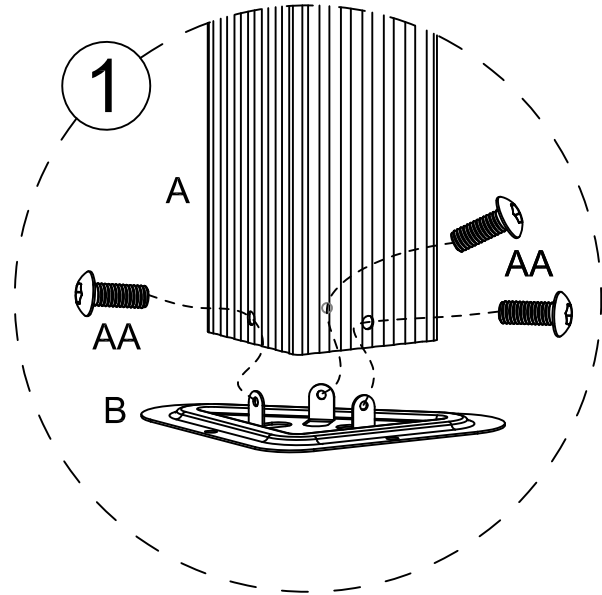
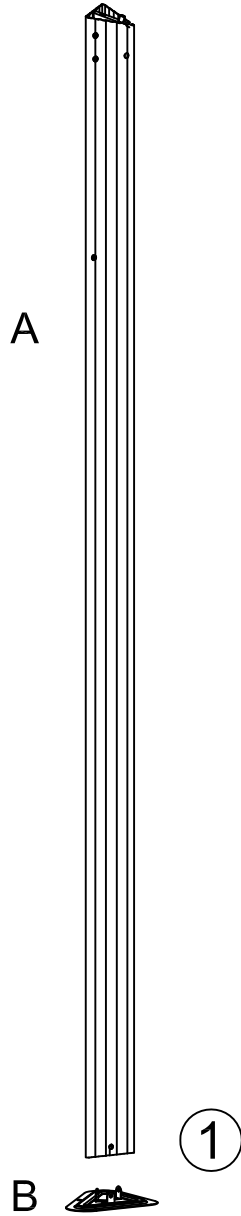

Step 1:

Secure base flange (B) to the bottom of post (A) by using bolts (AA). Repeat the step for all rest posts. Bolts can be tight completely.

C  x 2

D  x 2

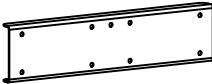
E  x 4

F  x 2

G  x 2

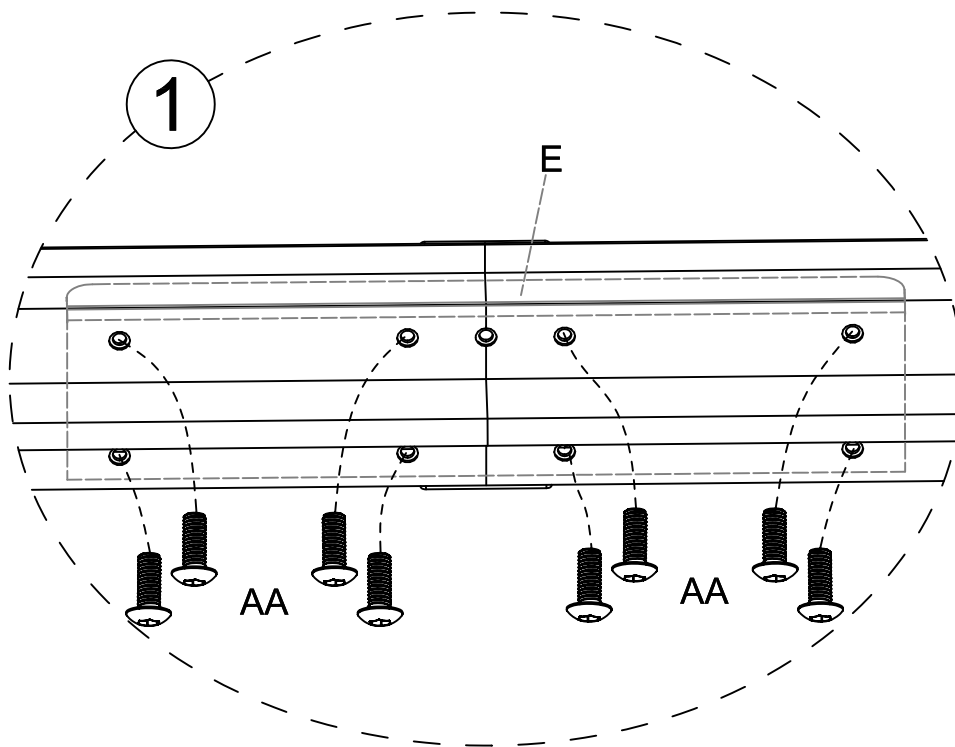
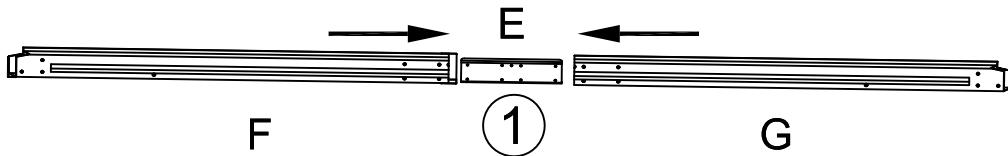
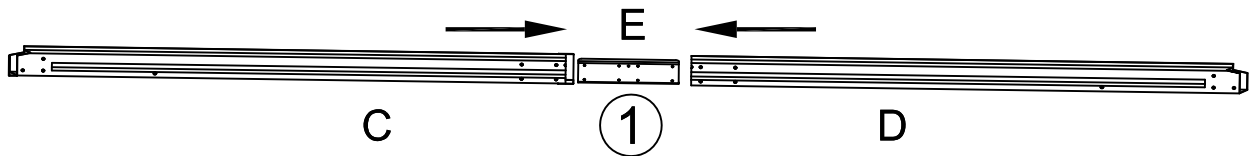

Step 2:

1. Insert the connector (E) into a long crossbar (C) and a long crossbar (D) as figure shown, and secure with bolts (AA). Bolts can be tight completely.

2. Insert the connector (E) into a short crossbar (F) and a short crossbar (G) as figure shown, and secure with bolts (AA). Bolts can be tight completely.

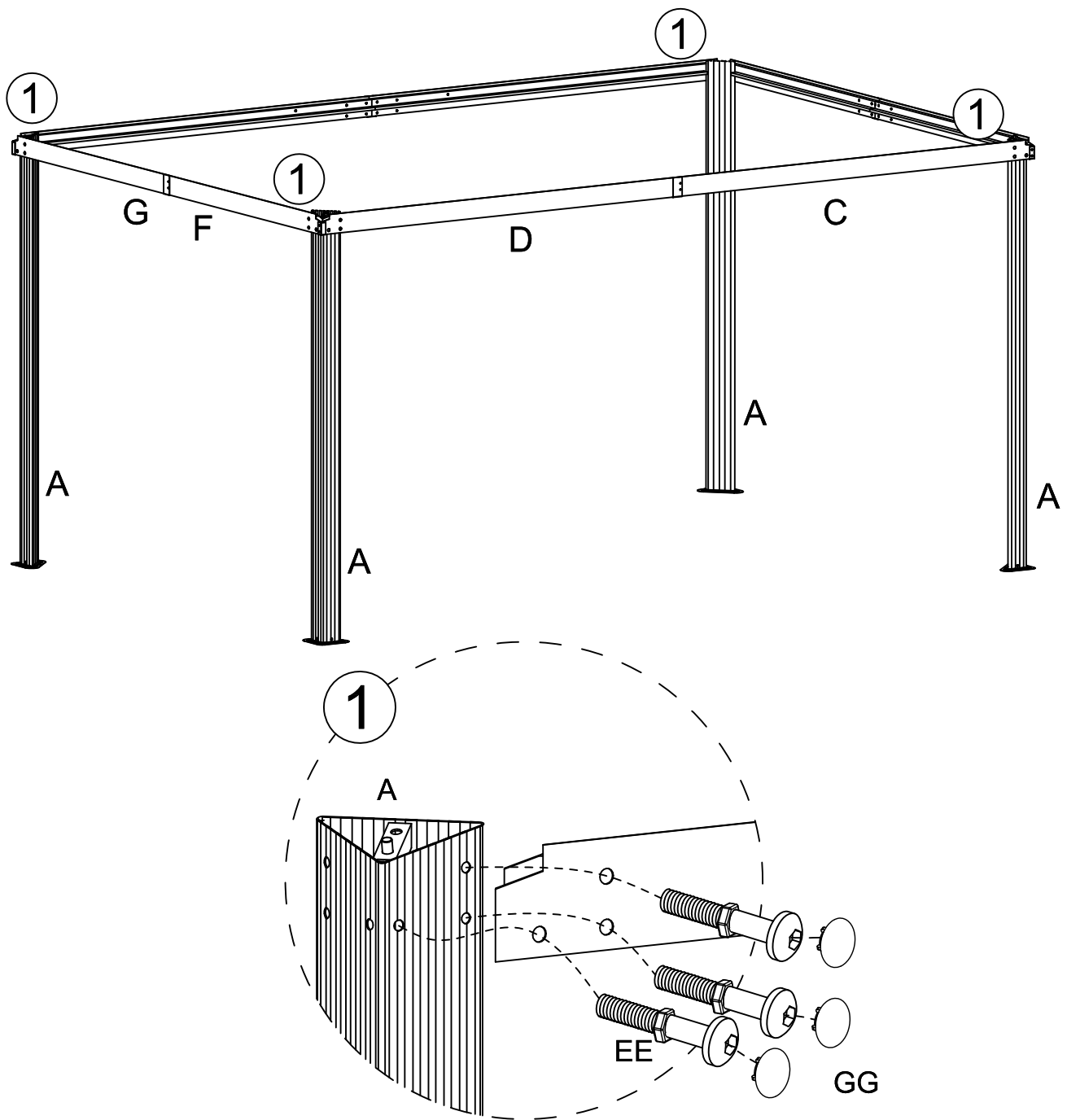

Step 3:

1. Secure long crossbars set (C & D) on two posts (A) by using half thread screws (EE). Do not tight bolts completely yet. Redo same procedure for the opposite side.

2. Secure a short crossbar set (F & G) on two posts (A) by using half thread screws (EE). Do not tight bolts completely yet. Redo same procedure for the opposite side.

3. Install plastic caps (GG) as fig. 1 shown.

Note: Please check above fig. carefully and make sure all the parts are in right position. For your security, you may need 4 people for this step.

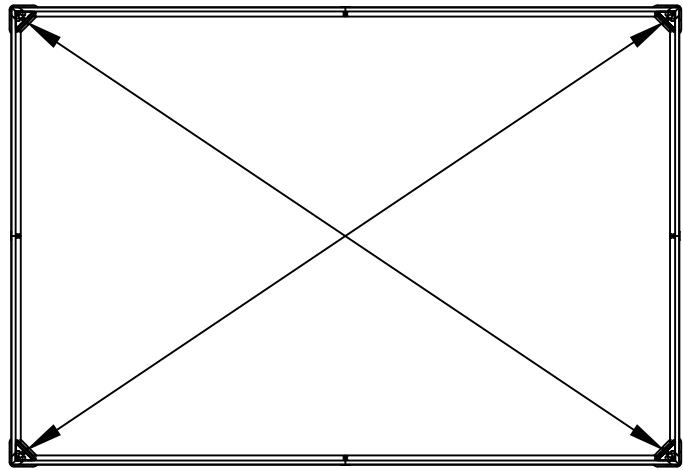
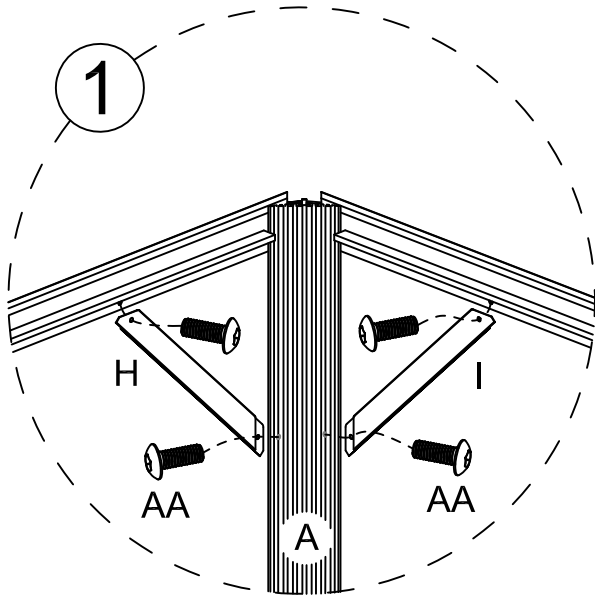
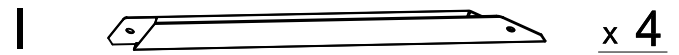
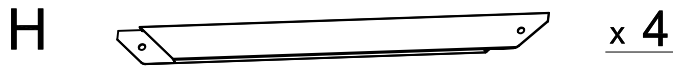

This is important to get square angles in crossbars corners so diagonal measurements (X) should be taken at top of posts in corners and get the same for both. This care refer to get an easy assembly.

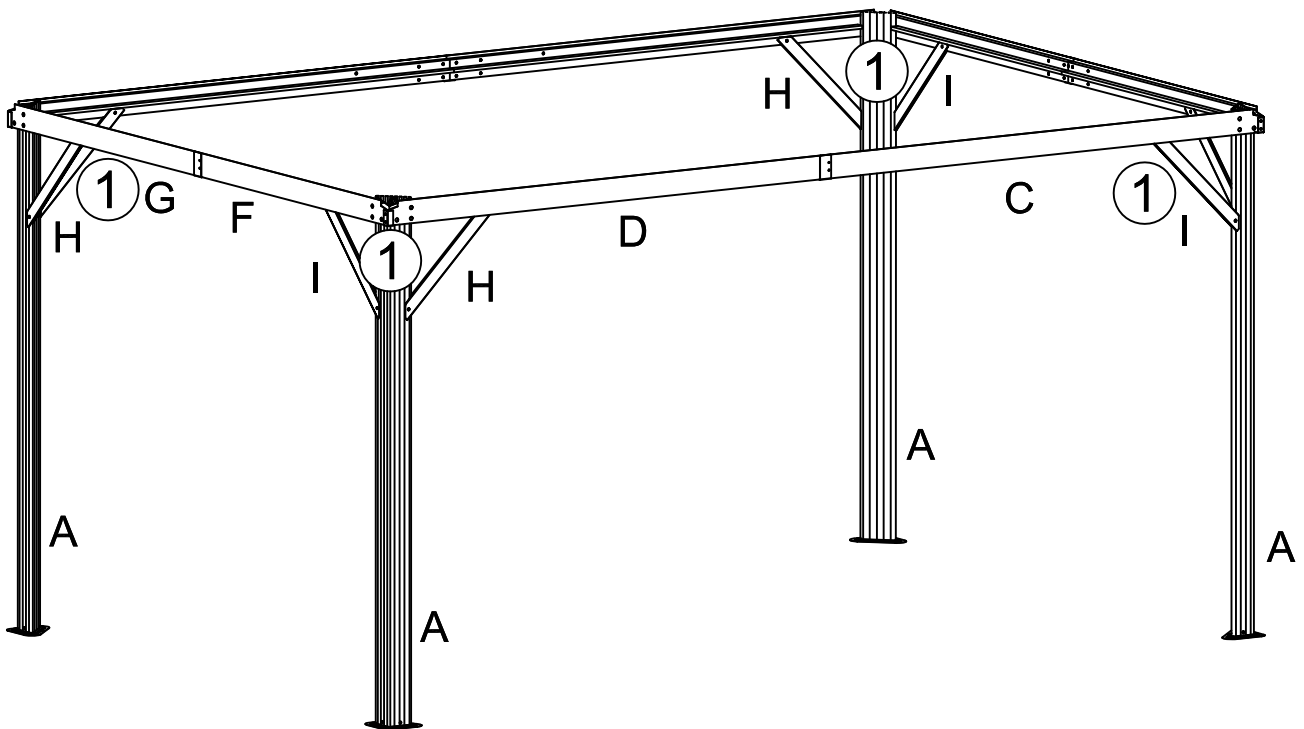





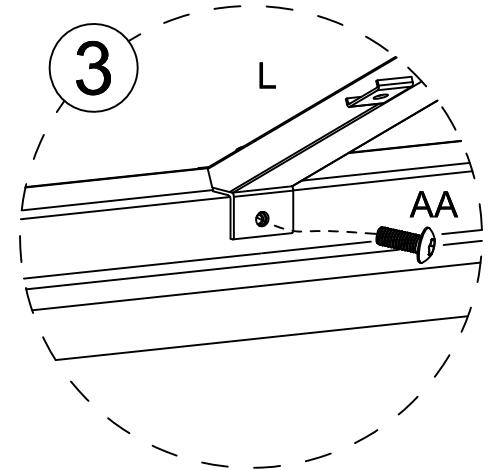
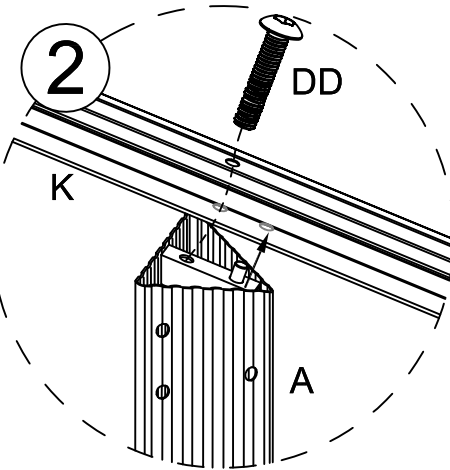
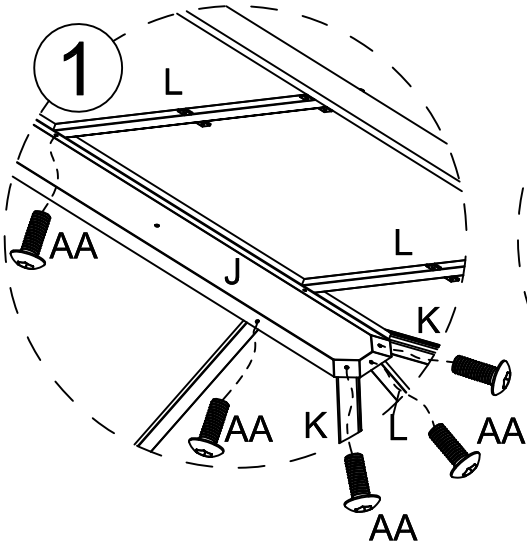
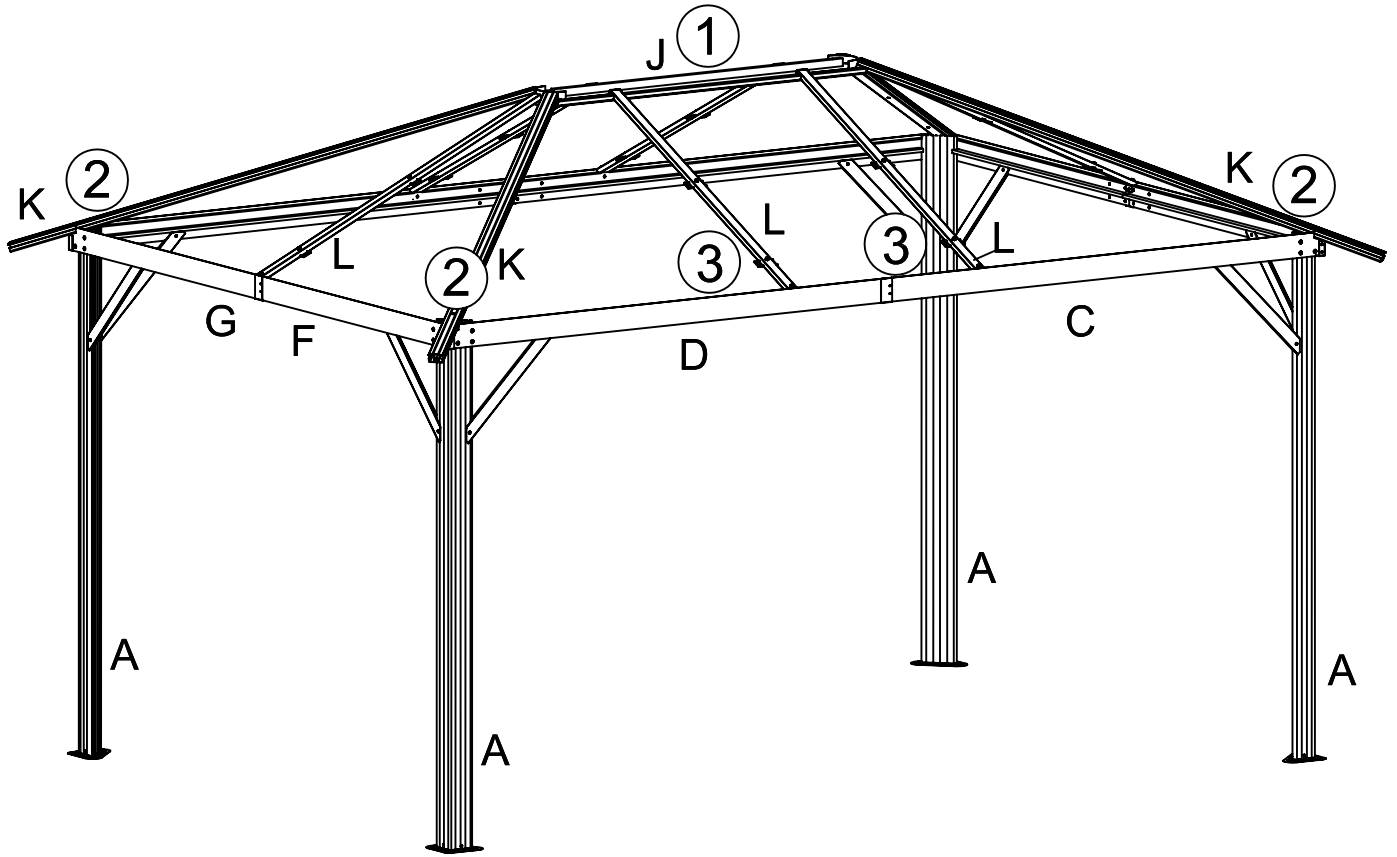
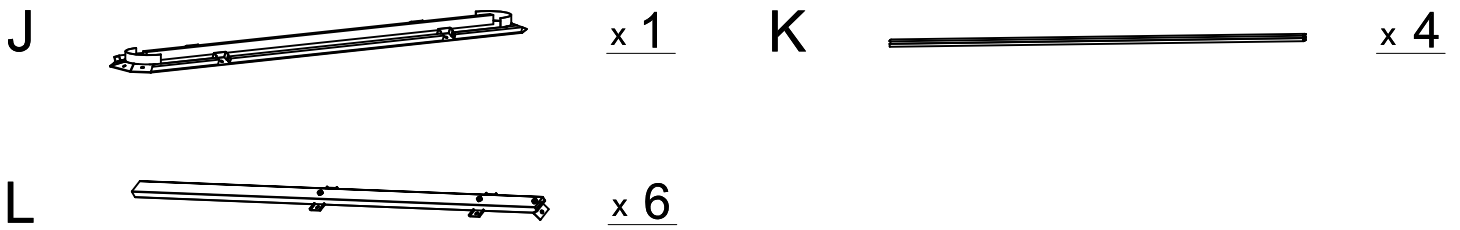





Step 4:

Secure left and right braces (I & H) to posts (A) by using bolts (AA) as fig.1 shown. Do not tight bolts yet. Then secure other end of braces (I & H) to short and long assembly crossbars (GFDC) by using bolts (AA) as fig.1. Prior final crossbars tightening, ensure assembly is fully aligned. Then, tight all loose bolts.



Step 5:

1. Secure corner roof tubes (K) to roof connector (J) using bolts (AA) as shown in fig. 1. Do not tight bolts completely yet. Lay down the corner roof tubes (K) on crossbars four corners and secure by using bolts (DD) as shown in fig. 2. Tight corner bolts but not full.
2. Secure roof support tubes (L) to roof connector (J) using bolts (AA) as shown in fig. 1. Do not tight bolts completely yet. Lay down other end of the roof support tubes (L) on crossbars and secure by using bolts (AA) as shown in fig. 3. Tight corner bolts but not full.

M		x 8	N		x 2
O		x 4	P		x 2
Q		x 2	R		x 2
S		x 2	T		x 2
U		x 2	V		x 2

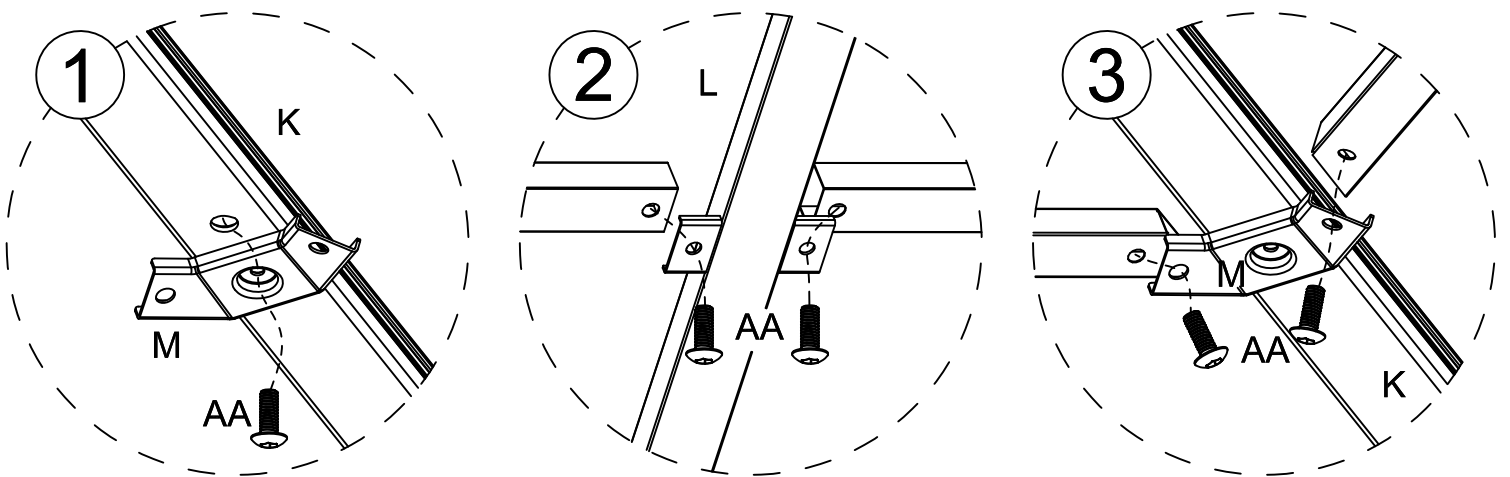
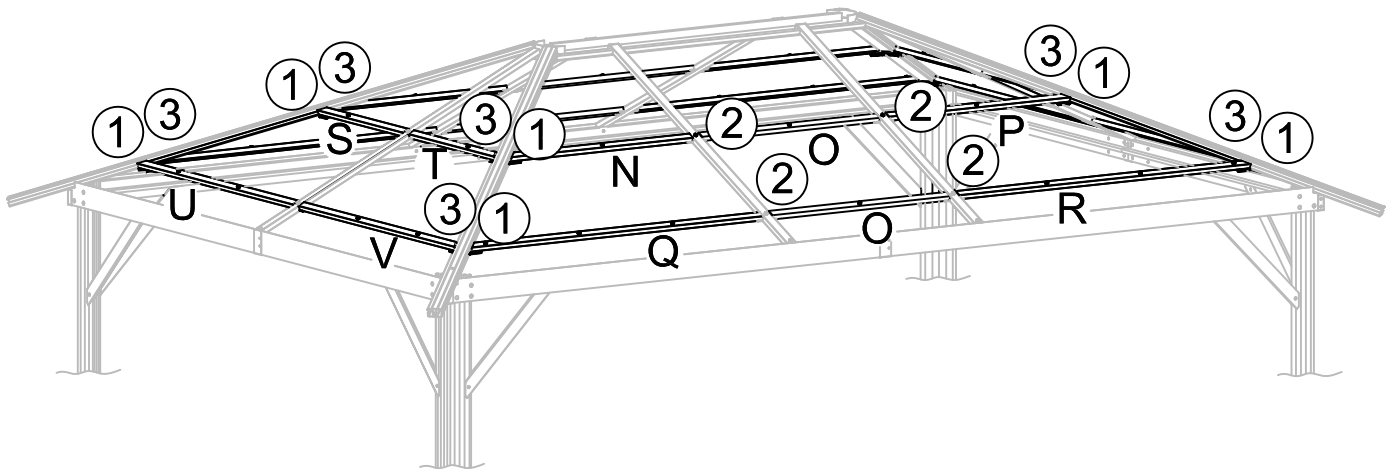

Step 6:

1. Secure corner connectors (M) on the corner roof tubes (K) by using bolts (AA). Align the parts in position as fig. 1 shown.

2. Secure roof support tubes (N & O & P & Q & R & S & T & U & V) on the connectors (M) & roof support tubes (L) by using bolts (AA). Align the parts in position as fig. 2 & 3 shown.

AM



x 1

AN

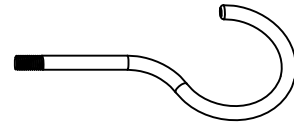



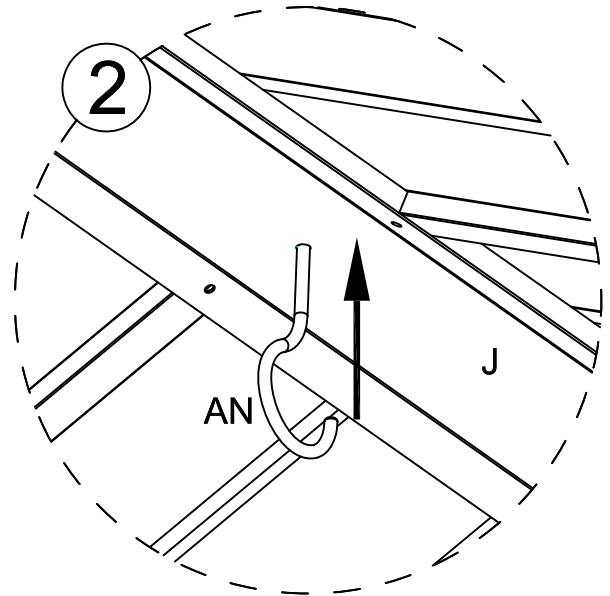
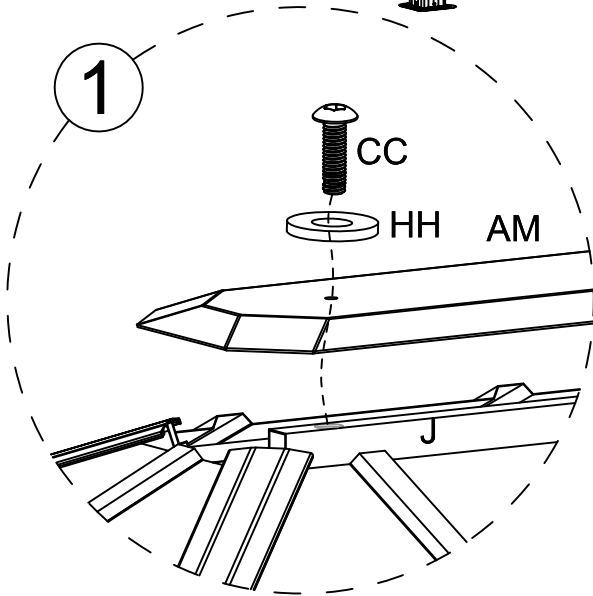
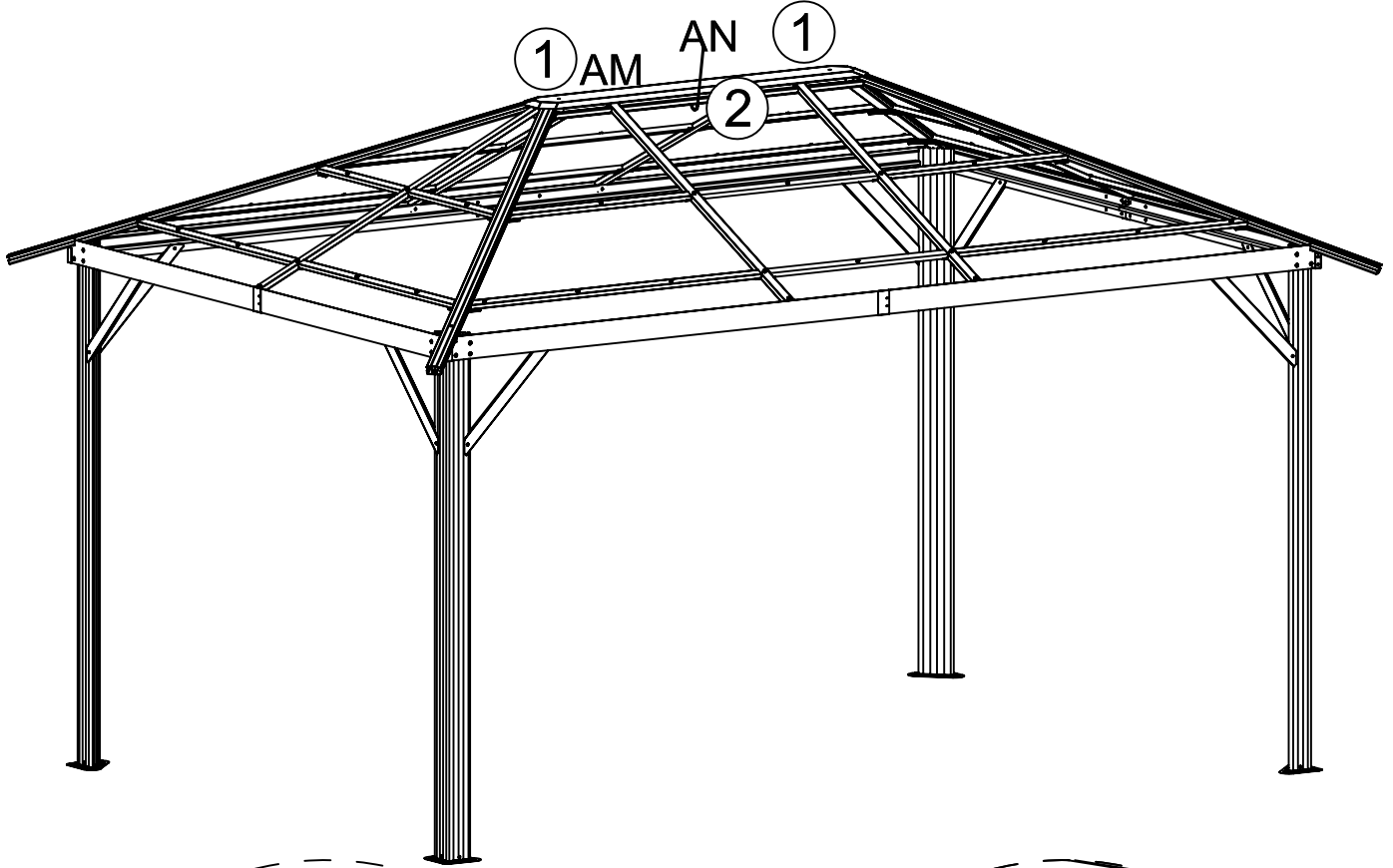

x 1

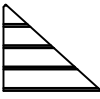
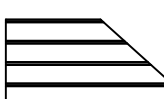
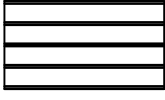
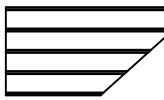
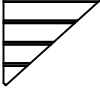

Step 7:

- 1. Insert bolts (CC) & plastic washers (HH) through roof cap (AM), and secure with roof connector (J) as shown. Tight bolts.
- 2. Secure hook (AN) to roof connector (J) as shown and tight hook.

W		x 2	X		x 2
Y		x 2	Z		x 2
AB		x 2	AG		x 2
AH		x 2	AI		x 2

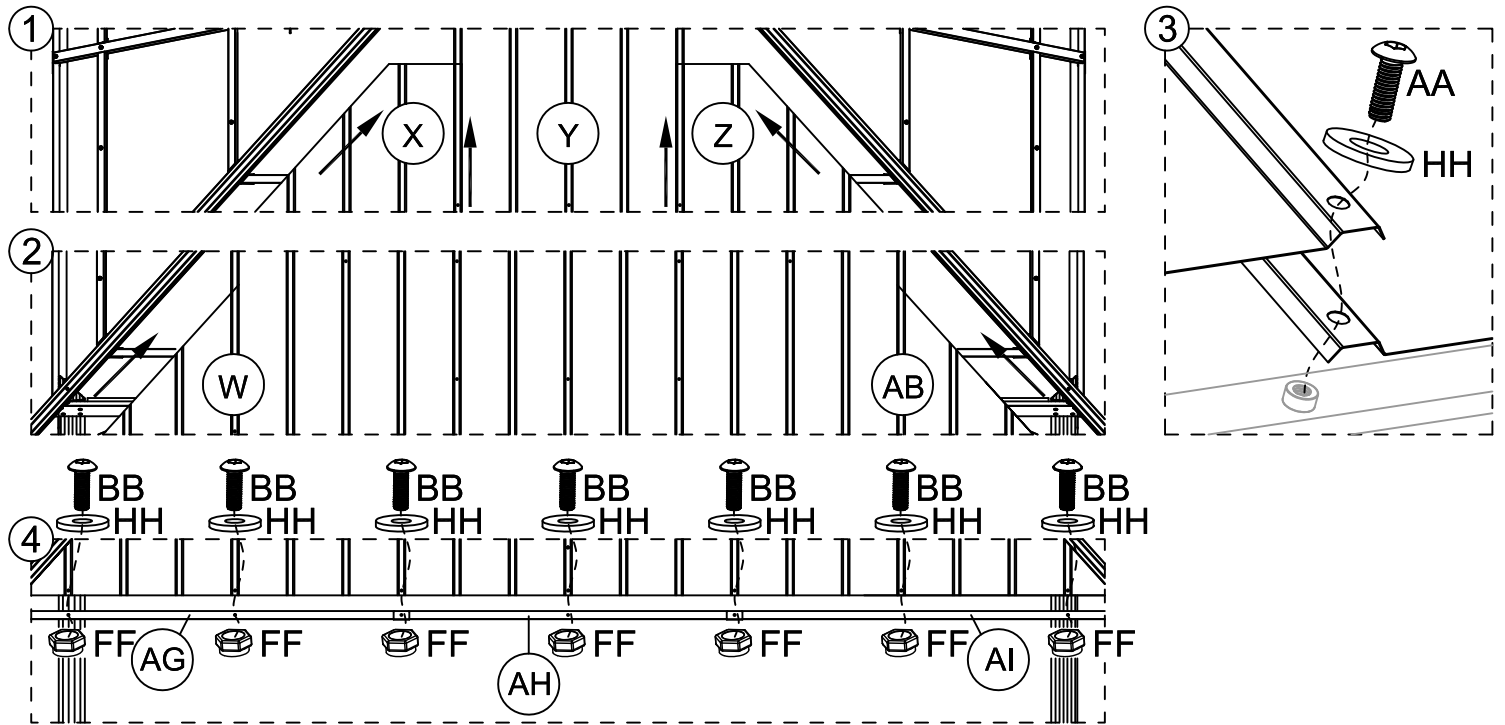
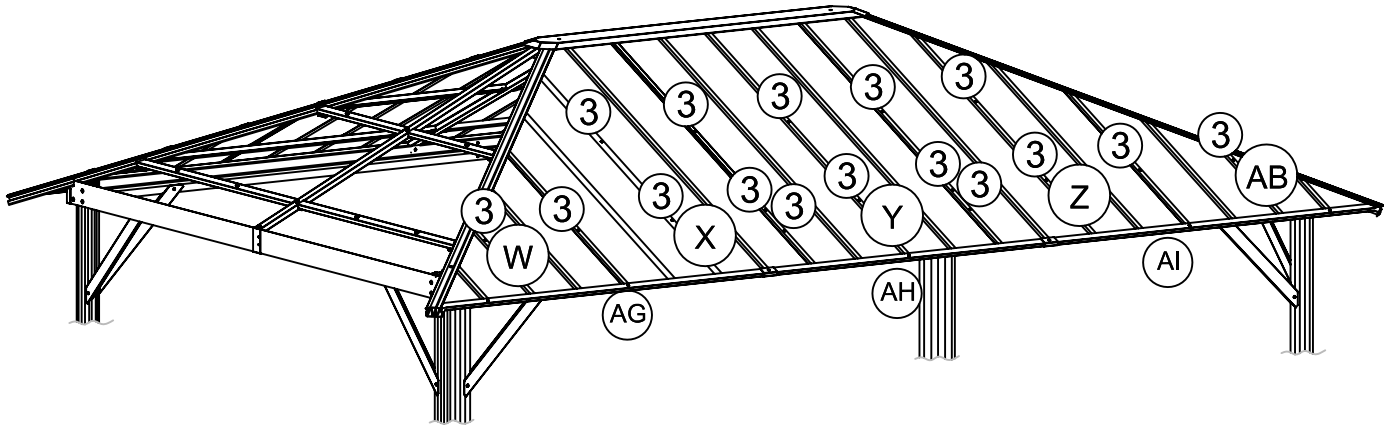







Step 8:

1.Lay down a middle roof panel (Y) on middle of the roof on the roof support tube (L) and under the roof cap (AM), and insert into corner roof tubes (K) groove. Note the left & right roof panels (X & Z) need to overlap. Use bolts (AA) and plastic washers (HH) to secure with roof support tubes (L & N & O & P & Q & R) as fig.1. & 3 shown.

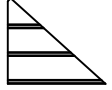
2.Then insert left & right roof panels (W & AB) into corner roof tubes (K) groove. Note the left & right roof panels (X & Z) need to overlap. Use bolts (AA) and plastic washers (HH) to secure with roof support tubes (Q & R) as fig.2 & 3 shown. Finally insert eave profiles (AG & AH & AI) at the end as fig.4 shown and secure with bolts (BB), plastic washers (HH) & nuts (FF).

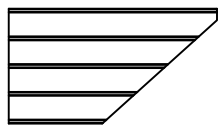
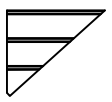
Repeat the steps 1 to 2 for opposite side.

Notes: Install clockwise to prevent the panels slide off.

AC		x 2	AD		x 2
AE		x 2	AF		x 2
AJ		x 2	AK		x 2
AL		x 4			

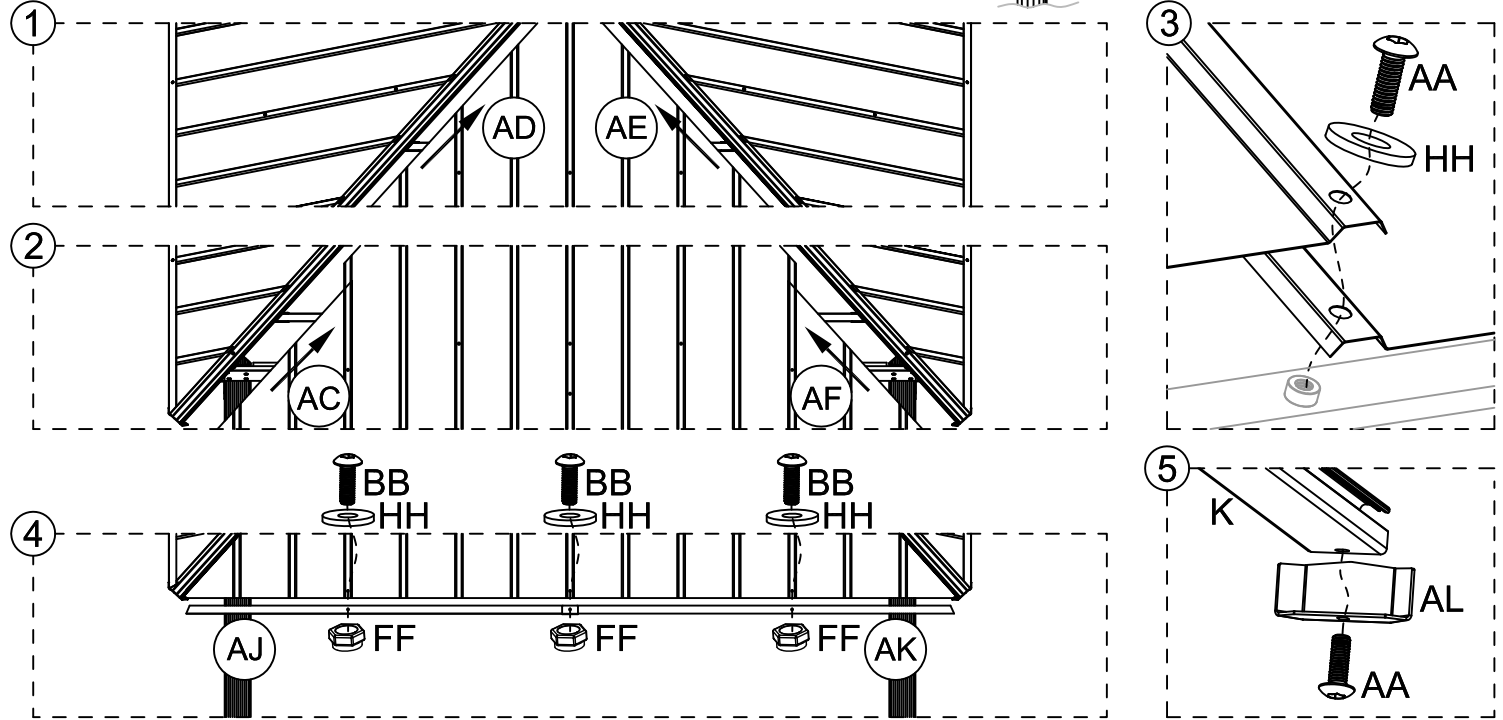
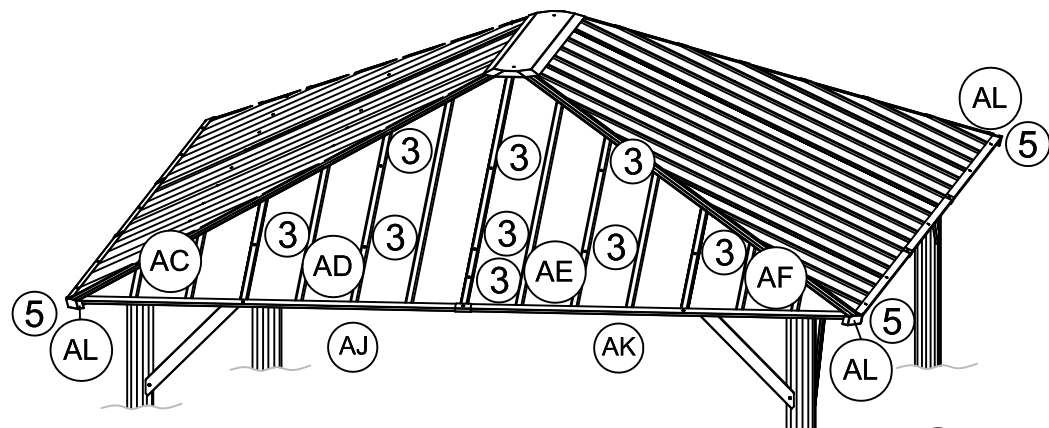

Step 9:

1. Lay down adjacent left & right roof panels (AD & AE) on middle of roof on the roof support tube (L) and under the roof cap (AM), and insert into corner roof tubes (K) groove. Note the left and right roof panels (AD & AE) need to overlap. Use bolts (AA) & plastic washers (HH) to secure with roof support tubes (L & S & T U & V) as fig.1 & 3 shown.
 2. Then insert left & right roof panels (AC & AF) into corner roof tubes (K) groove. Note the left & right roof panels (AD & AE) need to overlap. Use bolts (AA) & plastic washers (HH) to secure with roof support tubes (U & V) as fig 3. shown. Insert eave profiles (AJ & AK) at the end as fig.4 shown and secure with bolts (BB), plastic washers (HH) & nuts (FF).
 3. Finally insert bolts (AA) through corner connectors (AL), secure with corner roof tubes (K) as fig. 5 shown. Repeat the steps 1 to 3 for opposite side.
- Notes: Install clockwise to prevent the panels slide off.

AO

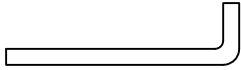

x 12

AP

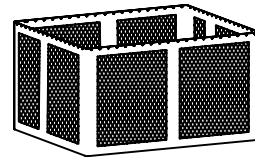

x 1

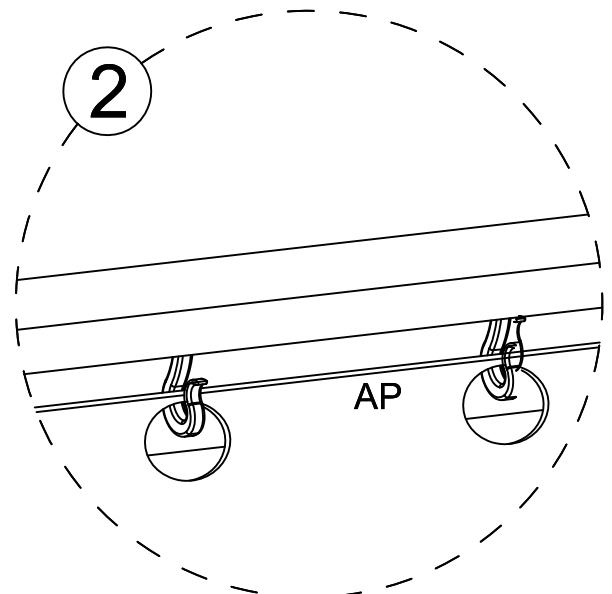
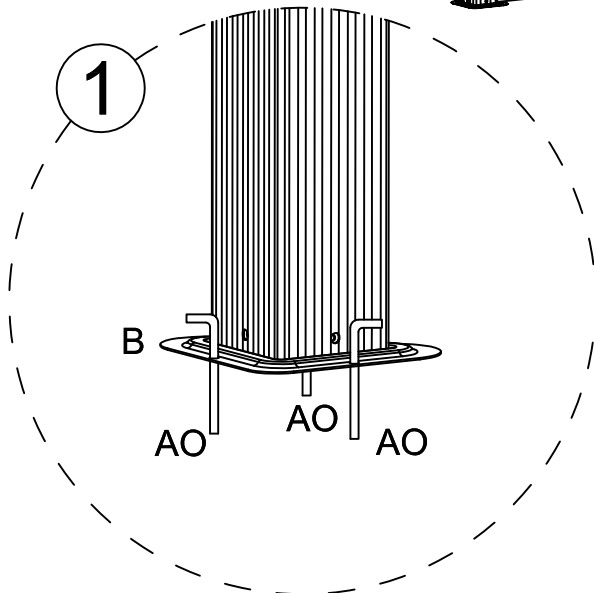
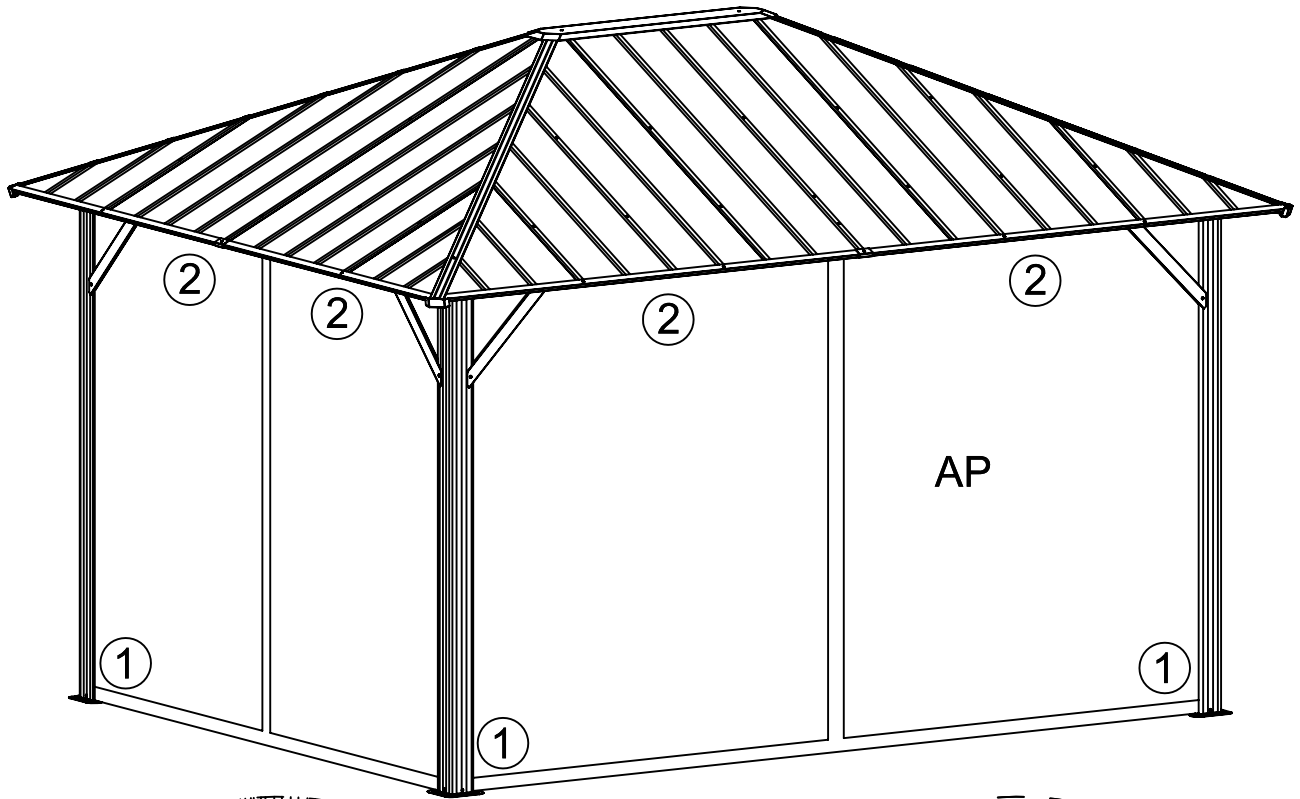
**Step 10:**

1. Hang the mosquito net (AP) by hooks properly.
2. Secure stakes (AO) through base flanges (B) into the ground.
Depend of patio surface, use proper anchoring devices. Anchors are not supplied.

3. Remove all gazebo assembly stickers.

4. Final tightening of all remaining untight bolts.

Please ensure posts and ground are perpendicular with each other once the unit is assembled. Enjoy your leisure time with the gazebo.

Winter Post

The use of a winter post allows additional support to the structure of the gazebo, meaning a delay for cleaning snow from the roof. The warranty does not cover a collapsing of the frame caused by snow build up.

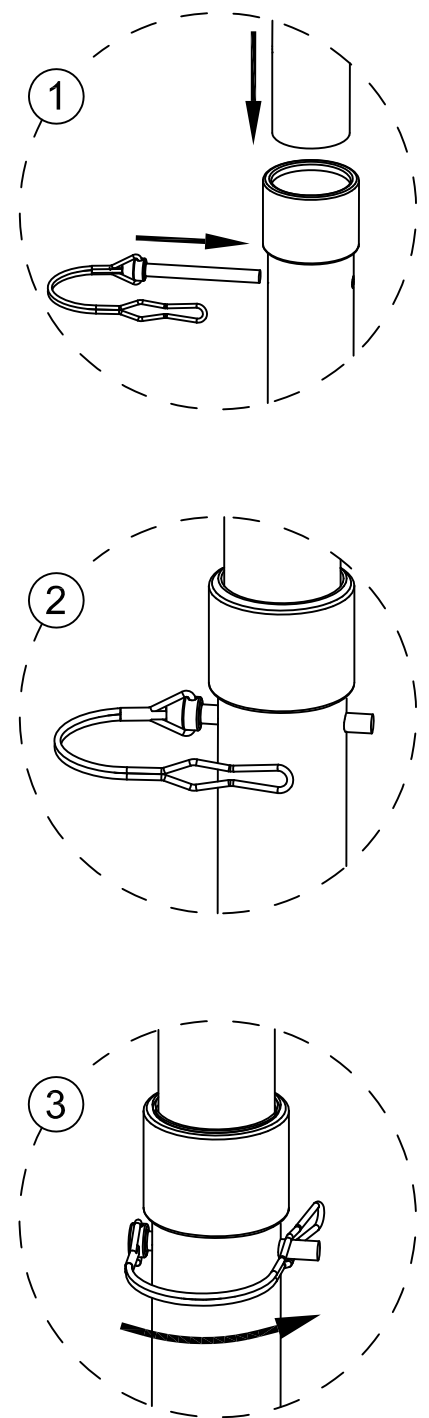
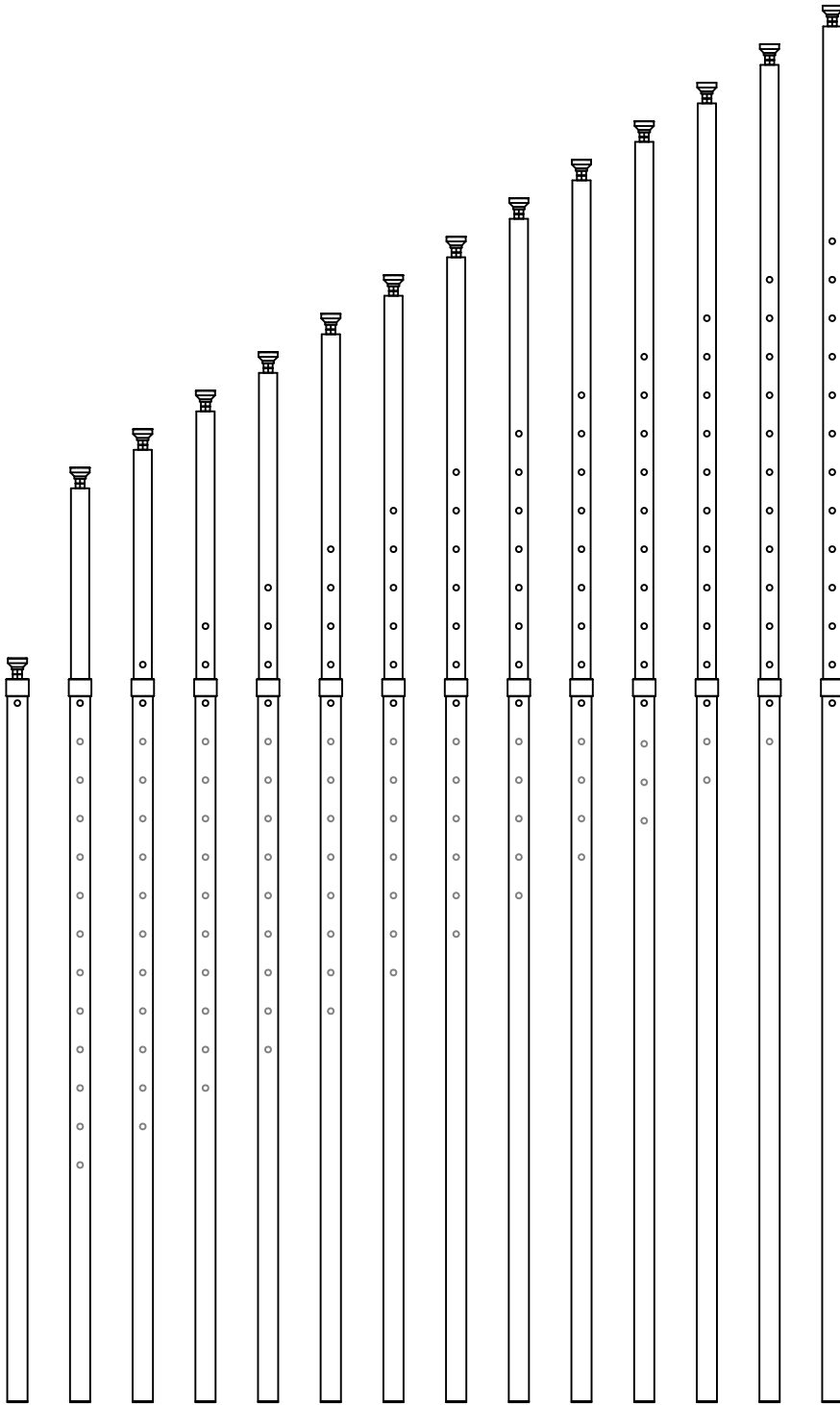

Adjust the height

AQ

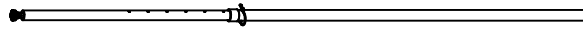

x 2

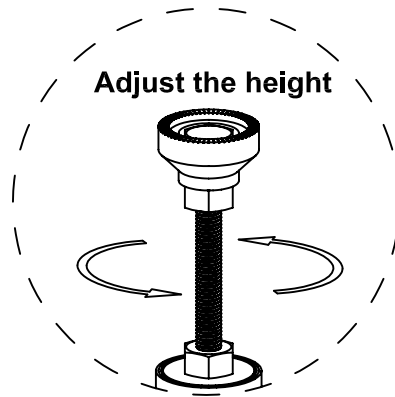
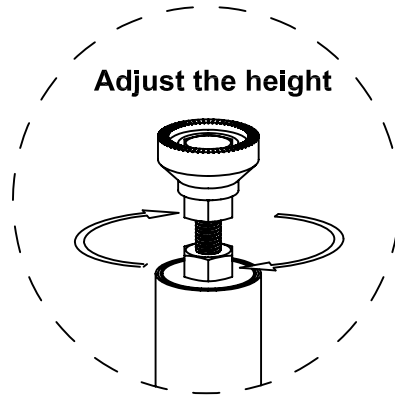
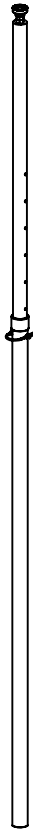

Rotary screw adjust the height

