

SN-1212

FEATURES:

- * Shower Niche
- * Material: Stainless Steel
- * Polished chrome finish
- * Warranty: One Year Limited Warranty



CODES / STANDARDS APPLICABLE

- * CSA B45
- * ASME A112.19.2

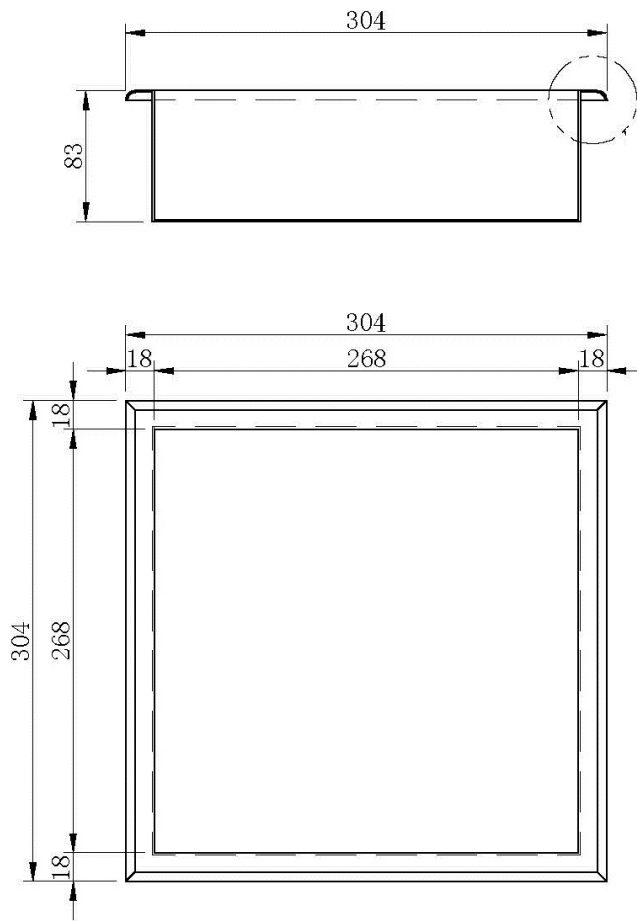

JOB INFORMATION:

Job Name _____

Date Specified _____

Contractor _____

Specifications and drawings provided on this sheet are for illustration only. Cantrio Concepts will not be held responsible for cutouts made without the actual product or product template.

Dimensions may vary within industry standard tolerances. Cantrio Concepts reserves the right to make changes without notice.