



**INSTRUCTIONS D'ASSEMBLAGE**  
**ASSEMBLY INSTRUCTIONS**

---

**M**ONARCH  
SPECIALTIES INC.

# I 2506

---

**MEUBLE TV -**  
**36" L / METAL NOIR ET VERRE TREMPE NOIR**

**TV STAND -**  
**36" L / BLACK METAL WITH TEMPERED BLACK GLASS**







**POUR DE L'ASSISTANCE OU POUR COMMANDER  
DES PIÈCES CONTACTEZ NOTRE DÉPARTEMENT  
DE SERVICE À LA CLIENTÈLE.**

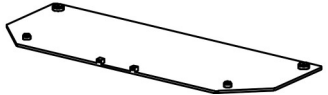

**FOR ASSISTANCE OR TO ORDER PARTS  
CONTACT OUR CUSTOMER SERVICE DEPARTMENT**

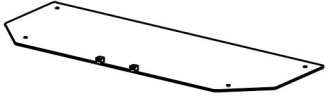
**WWW.MONARCHSERVICE.COM**

**LISTE DES PIÈCES**  
**PARTS LIST**

PIÈCE / PART #	IMAGE	DESCRIPTION	QTY / QTÉ
1		GLASS TOP SURFACE EN VERRE	1
2		GLASS SHELF ÉTAGÈRE EN VERRE	1
3		GLASS SHELF ÉTAGÈRE EN VERRE	1
4		BACK PANEL PANNEAU ARRIÈRE	1
5		SUPPORT BAR BARRE DE SOUTIEN	4

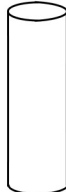
**LISTE DES PIÈCES**  
**PARTS LIST**

PIÈCE / PART #	IMAGE	DESCRIPTION	QTY / QTÉ
6		SUPPORT BAR BARRE DE SOUTIEN	4
7		LEG PATTE	2
8		LEG PATTE	2

**LISTE DES PIÈCES DE MONTAGE**  
**HARDWARE LIST**

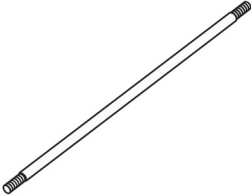
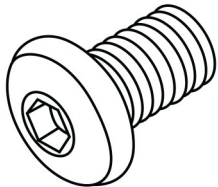
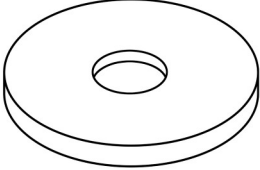
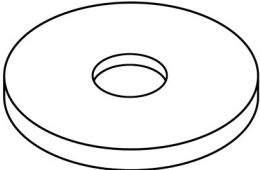
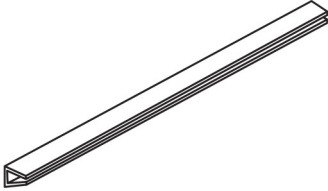
PIÈCE / PART #	IMAGE	DESCRIPTION	QTY / QTÉ
A		<p align="center">THREADED ROD - 20 5/8"</p> <p align="center">TIGE FILETÉE - 20 5/8"</p>	4
B		<p align="center">ASSEMBLING BOLT - Ø 1/4" X 3/8"</p> <p align="center">BOULON D'ASSEMBLAGE - Ø 1/4" X 3/8"</p>	4
C		<p align="center">PLASTIC WASHER - Ø 1 1/2"</p> <p align="center">RONDELLE DE PLASTIQUE - Ø 1 1/2"</p>	8
D		<p align="center">PLASTIC WASHER - Ø 1"</p> <p align="center">RONDELLE DE PLASTIQUE - Ø 1"</p>	8
E		<p align="center">RUBBER CAOUTCHOUC</p>	2

**LISTE DES PIÈCES DE MONTAGE**  
**HARDWARE LIST**

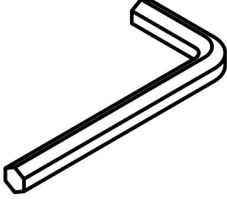
PIÈCE / PART #	IMAGE	DESCRIPTION	QTY / QTÉ
F		HEX KEY CLÉ HEXAGONALE	1



OUTIL DE VÉRIFICATION DE DIMENSIONS DES PIÈCES  
HARDWARE DIMENSIONS VERIFICATION TOOL

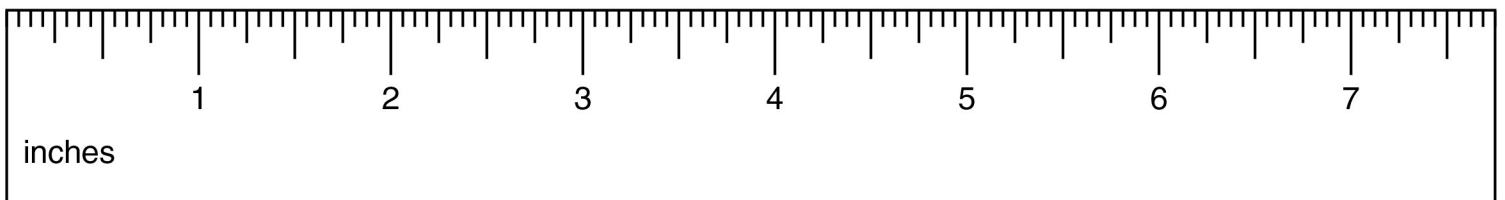

ÉTAPE / STEP 1

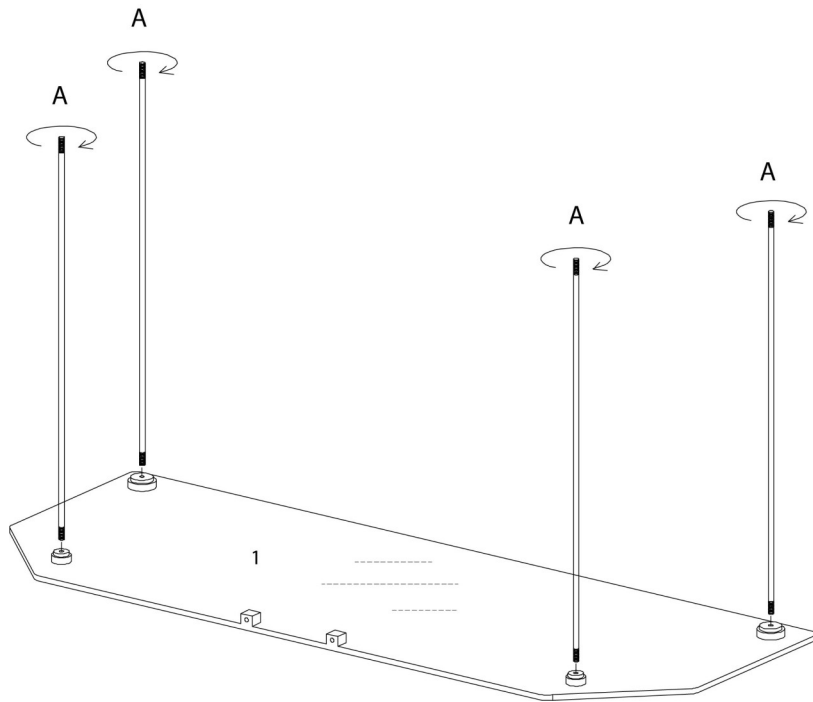

ÉTAPE / STEP 2

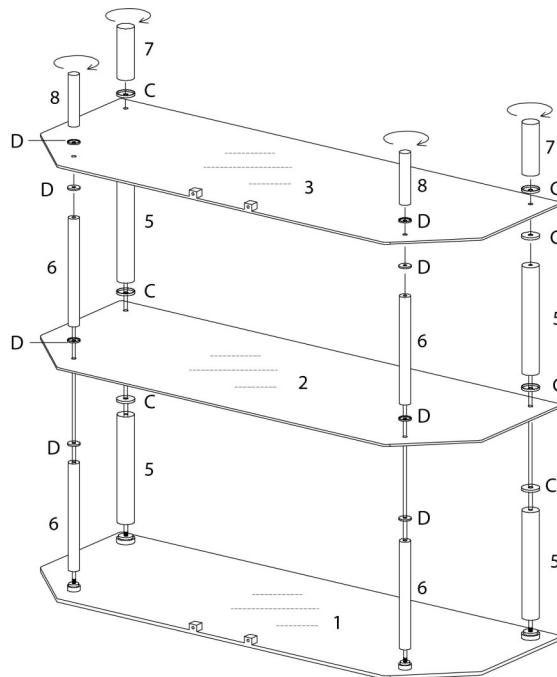

ÉTAPE / STEP 3

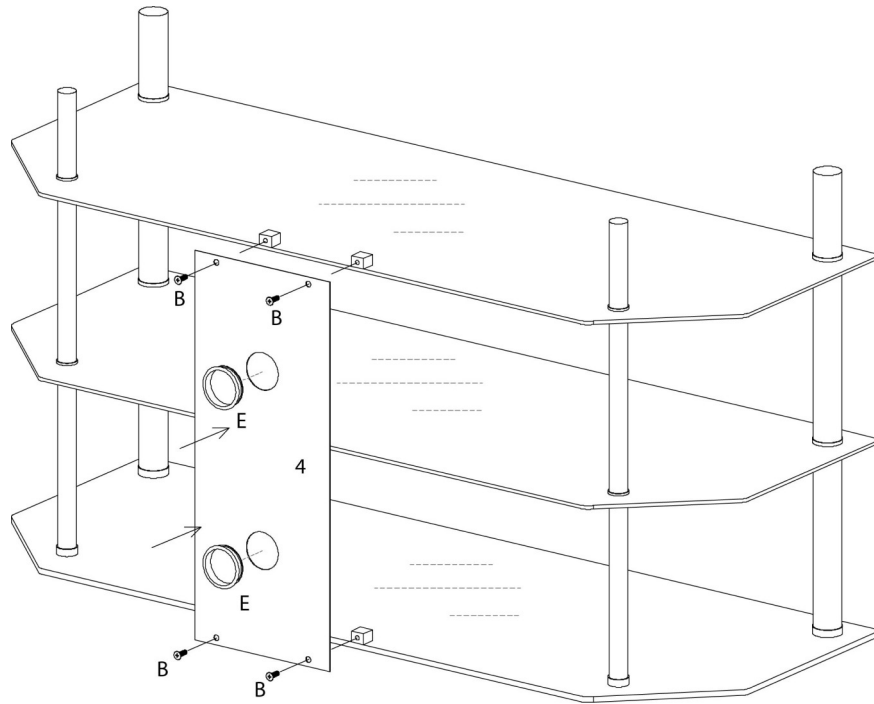



ÉTAPE / STEP 4

