



INSTRUCTIONS D'ASSEMBLAGE
ASSEMBLY INSTRUCTIONS

MONARCH
SPECIALTIES INC.

I 2500

MEUBLE TV -
60" L / METAL NOIR AVEC VERRE TREMPE NOIR

TV STAND -
60" L / BLACK METAL WITH BLACK TEMPERED
GLASS







POUR DE L'ASSISTANCE OU POUR COMMANDER
DES PIÈCES CONTACTEZ NOTRE DÉPARTEMENT
DE SERVICE À LA CLIENTÈLE.

FOR ASSISTANCE OR TO ORDER PARTS
CONTACT OUR CUSTOMER SERVICE DEPARTMENT

WWW.MONARCHSERVICE.COM

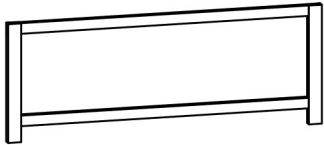
LISTE DES PIÈCES
PARTS LIST

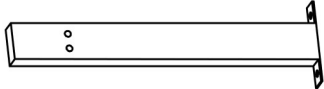
| PIÈCE / PART # | IMAGE | DESCRIPTION | QTY / QTÉ |
|----------------|---|--|-----------|
| 1 |  | GLASS TOP SURFACE EN VERRE | 1 |
| 2 |  | GLASS SHELF ÉTAGÈRE EN VERRE | 1 |
| 3 |  | FRAME CADRE | 1 |
| 4 |  | TOP FRAME CADRE DE SURFACE | 1 |
| 5 |  | BACK LEG SUPPORT BARRE DE SOUTIEN ARRIERE (TABLE) | 2 |

LISTE DES PIÈCES
PARTS LIST

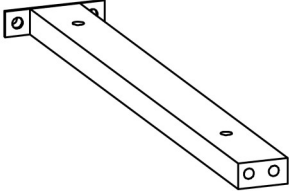
| PIÈCE / PART # | IMAGE | DESCRIPTION | QTY / QTÉ |
|----------------|---|---------------------------------|-----------|
| 6 |  | SUPPORT BAR BARRE DE SOUTIEN | 2 |

LISTE DES PIÈCES DE MONTAGE
HARDWARE LIST

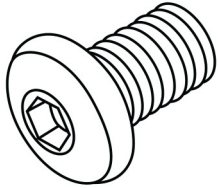
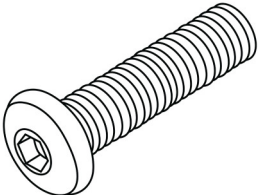
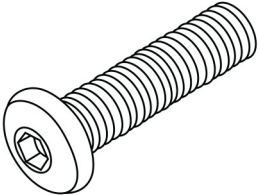
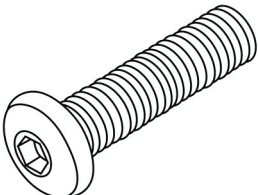
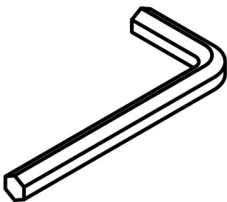
| PIÈCE / PART # | IMAGE | DESCRIPTION | QTY / QTÉ |
|----------------|---|---|-----------|
| A |  | <p align="center">ASSEMBLING BOLT - Ø 1/4" X 1/2"</p> <p align="center">BOULON D'ASSEMBLAGE - Ø 1/4" X 1/2"</p> | 12 |
| B |  | <p align="center">ASSEMBLING BOLT - Ø 1/4" X 1"</p> <p align="center">BOULON D'ASSEMBLAGE - Ø 1/4" X 1"</p> | 4 |
| C |  | <p align="center">ASSEMBLING BOLT - Ø 1/4" X 1 3/4"</p> <p align="center">BOULON D'ASSEMBLAGE - Ø 1/4" X 1 3/4"</p> | 4 |
| D |  | <p align="center">ASSEMBLING BOLT - Ø 1/4" X 2 1/8"</p> <p align="center">BOULON D'ASSEMBLAGE - Ø 1/4" X 2 1/8"</p> | 4 |
| E |  | <p align="center">HEX KEY</p> <p align="center">CLÉ HEXAGONALE</p> | 1 |

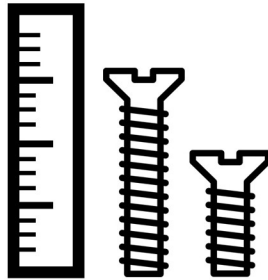

OUTIL DE VÉRIFICATION DE DIMENSIONS DES PIÈCES
HARDWARE DIMENSIONS VERIFICATION TOOL

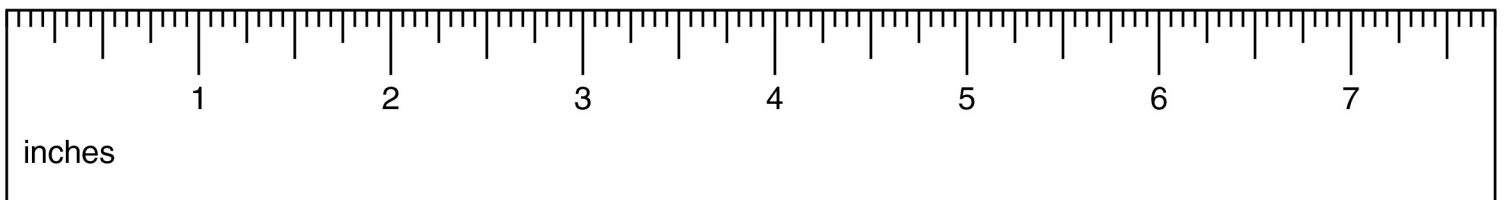

ÉTAPE / STEP 1

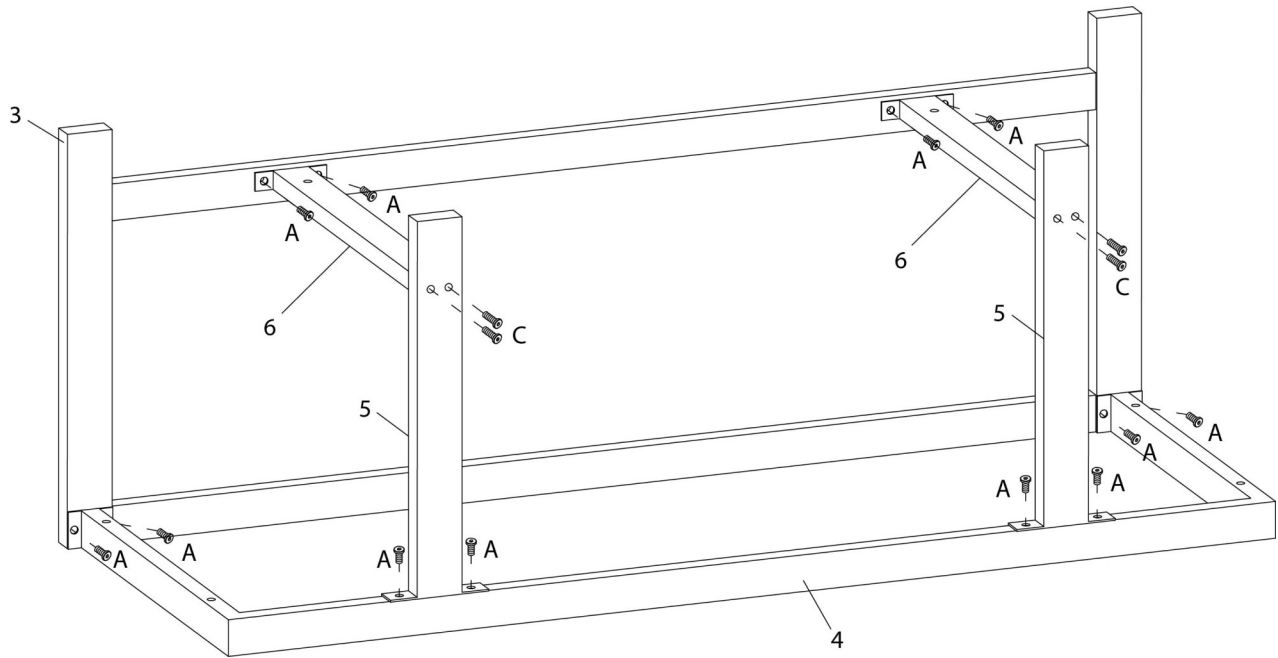

ÉTAPE / STEP 2

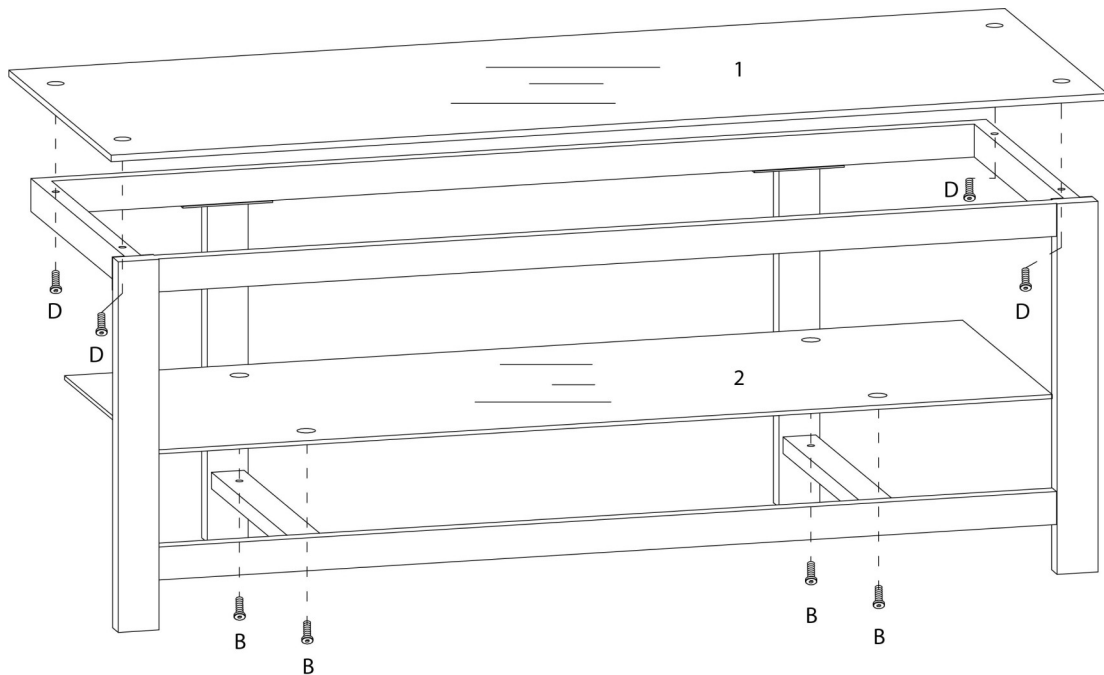

ÉTAPE / STEP 3

