



**INSTRUCTIONS D'ASSEMBLAGE**  
**ASSEMBLY INSTRUCTIONS**

---

**M**ONARCH  
SPECIALTIES INC.

# I 2068

---

**TABLE D'APPOINT -**  
**22"H / BLANC / ARGENT / VERRE TREMPE**

**ACCENT TABLE -**  
**22"H / WHITE / SILVER / TEMPERED GLASS**



**POUR DE L'ASSISTANCE OU POUR COMMANDER  
DES PIÈCES CONTACTEZ NOTRE DÉPARTEMENT  
DE SERVICE À LA CLIENTÈLE.**

**FOR ASSISTANCE OR TO ORDER PARTS  
CONTACT OUR CUSTOMER SERVICE DEPARTMENT**

**[WWW.MONARCHSERVICE.COM](http://WWW.MONARCHSERVICE.COM)**

---

**LISTE DES PIÈCES**  
**PARTS LIST**

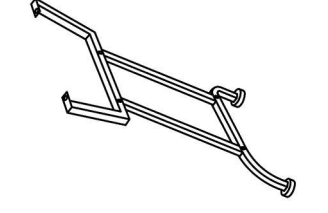
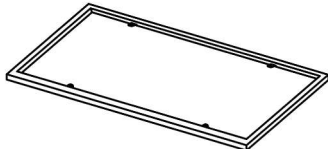
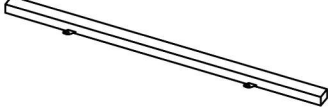
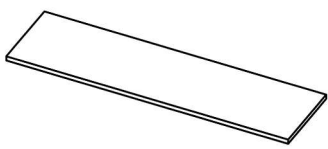
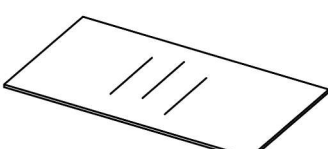
PIÈCE / PART #	IMAGE	DESCRIPTION	QTY / QTÉ
1		<p>METAL LEG            PATTE EN METAL</p>	2
2		<p>TOP FRAME            CADRE DE SURFACE</p>	1
3		<p>CROSSBAR            BARRE TRANSVERSALE</p>	4
4		<p>SHELF PANEL            PANNEAU DE TABLETTE</p>	2
5		<p>GLASS PANEL            PANNEAU EN VERRE</p>	1

**LISTE DES PIÈCES DE MONTAGE**  
**HARDWARE LIST**

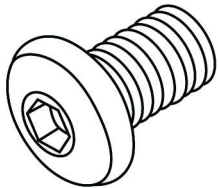
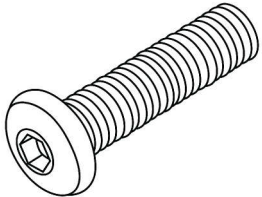
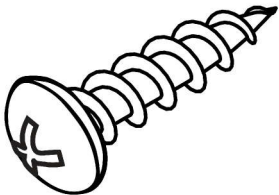
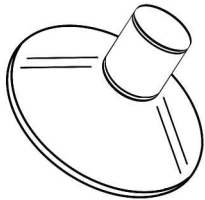
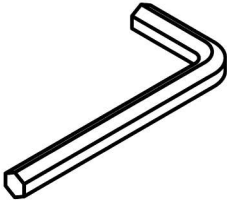
PIÈCE / PART #	IMAGE	DESCRIPTION	QTY / QTÉ
<b>A</b>		<b>ASSEMBLING BOLT -</b> <b>Ø1/4" X 1/2"</b> <b>BOULON D'ASSEMBLAGE -</b> <b>Ø1/4" X 1/2"</b>	<b>4</b>
<b>B</b>		<b>ASSEMBLING BOLT -</b> <b>Ø1/4" X 1 3/8"</b> <b>BOULON D'ASSEMBLAGE -</b> <b>Ø1/4" X 1 3/8"</b>	<b>8</b>
<b>C</b>		<b>ASSEMBLING SCREW -</b> <b>1/2"</b> <b>VIS D'ASSEMBLAGE -</b> <b>1/2"</b>	<b>8</b>
<b>D</b>		<b>SUCTION CUP -</b> <b>Ø3/4"</b> <b>VENTOUSE -</b> <b>Ø3/4"</b>	<b>4</b>
<b>E</b>		<b>HEX KEY</b> <b>CLÉ HEXAGONALE</b>	<b>1</b>

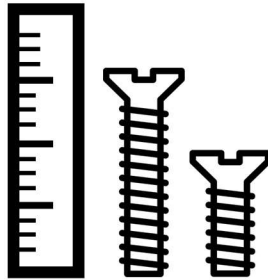

OUTIL DE VÉRIFICATION DE DIMENSIONS DES PIÈCES  
HARDWARE DIMENSIONS VERIFICATION TOOL

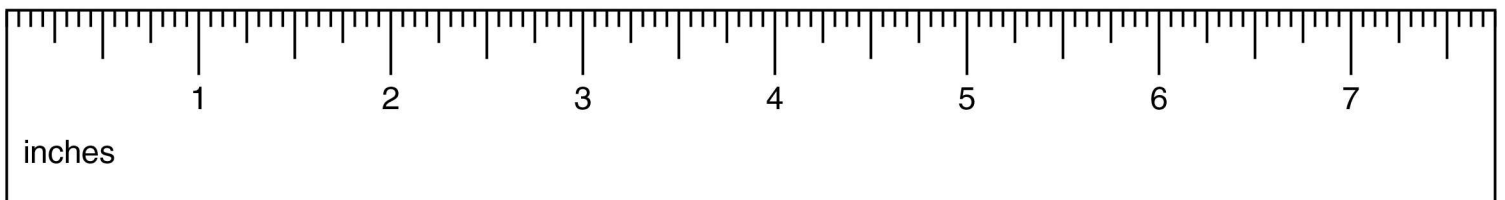

ÉTAPE / STEP 1

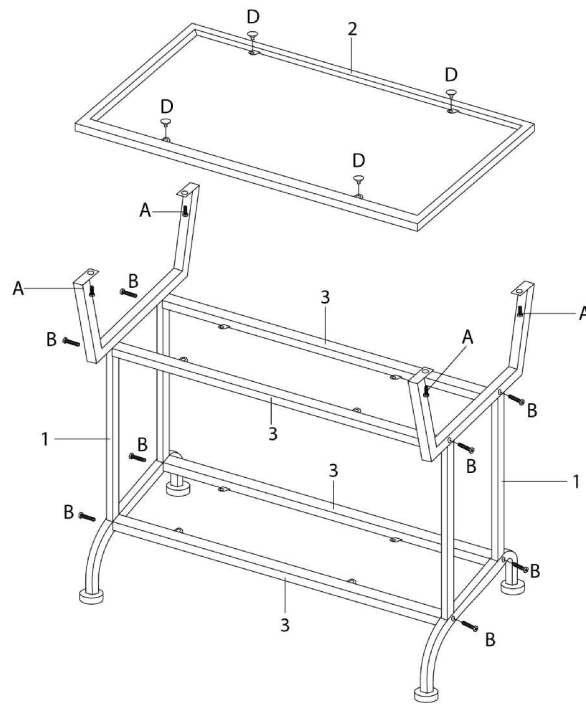

ÉTAPE / STEP 2

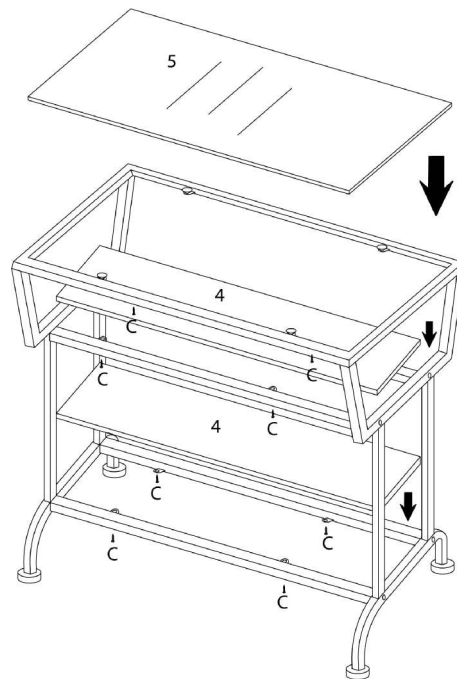

ÉTAPE / STEP 3

