



**INSTRUCTIONS D'ASSEMBLAGE**  
**ASSEMBLY INSTRUCTIONS**

---

**M**ONARCH  
SPECIALTIES INC.

**I 3187**

---

**TABLE D'APPOINT -**  
**GRIS ET METAL CHROME**

**ACCENT TABLE -**  
**GREY WITH CHROME METAL**





**POUR DE L'ASSISTANCE OU POUR COMMANDER  
DES PIÈCES CONTACTEZ NOTRE DÉPARTEMENT  
DE SERVICE À LA CLIENTÈLE.**

**FOR ASSISTANCE OR TO ORDER PARTS  
CONTACT OUR CUSTOMER SERVICE DEPARTMENT**

**WWW.MONARCHSERVICE.COM**

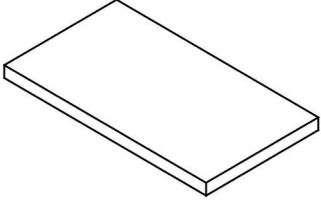
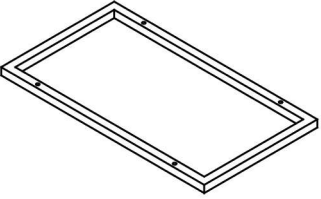
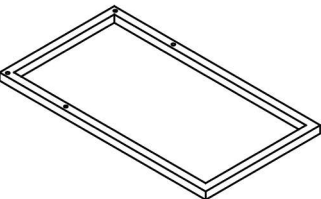
**LISTE DES PIÈCES**  
**PARTS LIST**

PIÈCE / PART #	IMAGE	DESCRIPTION	QTY / QTÉ
1		TABLE TOP SURFACE DE TABLE	1
2		TOP FRAME CADRE DE SURFACE	1
3		BOTTOM FRAME CADRE DU BAS	1
4		FRONT FACING LEFT LEG PATTE AVANT GAUCHE	1
5		FRONT FACING RIGHT LEG PATTE AVANT DROITE	1

**LISTE DES PIÈCES DE MONTAGE**  
**HARDWARE LIST**

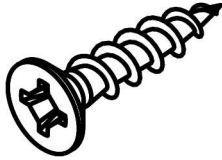
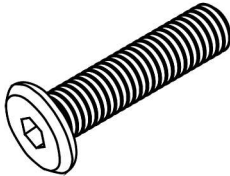
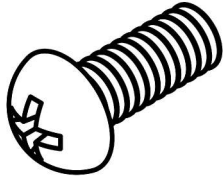
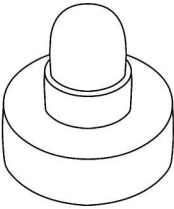
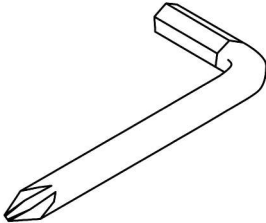
PIÈCE / PART #	IMAGE	DESCRIPTION	QTY / QTÉ
<b>A</b>		<b>ASSEMBLING SCREW -</b> <b>Ø3/8" X 1 1/4"</b>  <b>VIS D'ASSEMBLAGE -</b> <b>Ø3/8" X 1 1/4"</b>	<b>4</b>
<b>B</b>		<b>ASSEMBLING BOLT -</b> <b>Ø1/4" X 7/8"</b>  <b>BOULON D'ASSEMBLAGE -</b> <b>Ø1/4" X 7/8"</b>	<b>4</b>
<b>C</b>		<b>ASSEMBLING BOLT -</b> <b>Ø1/8" X 1/2"</b>  <b>BOULON D'ASSEMBLAGE -</b> <b>Ø1/8" X 1/2"</b>	<b>4</b>
<b>D</b>		<b>FLOOR PROTECTOR -</b> <b>Ø1/4"</b>  <b>PROTECTEUR DE PLANCHER -</b> <b>Ø1/4"</b>	<b>4</b>
<b>E</b>		<b>HEX KEY</b>  <b>CLÉ HEXAGONALE</b>	<b>1</b>

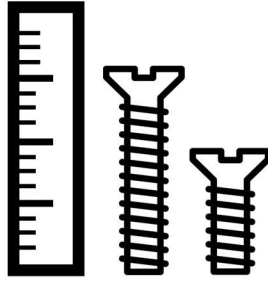

OUTIL DE VÉRIFICATION DE DIMENSIONS DES PIÈCES  
HARDWARE DIMENSIONS VERIFICATION TOOL

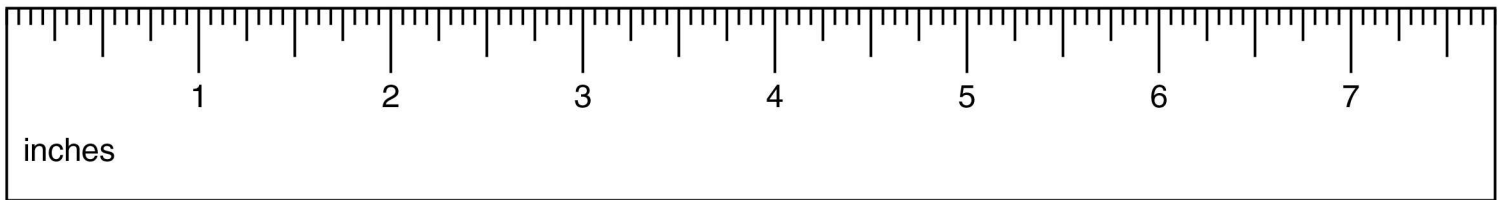

ÉTAPE / STEP 1

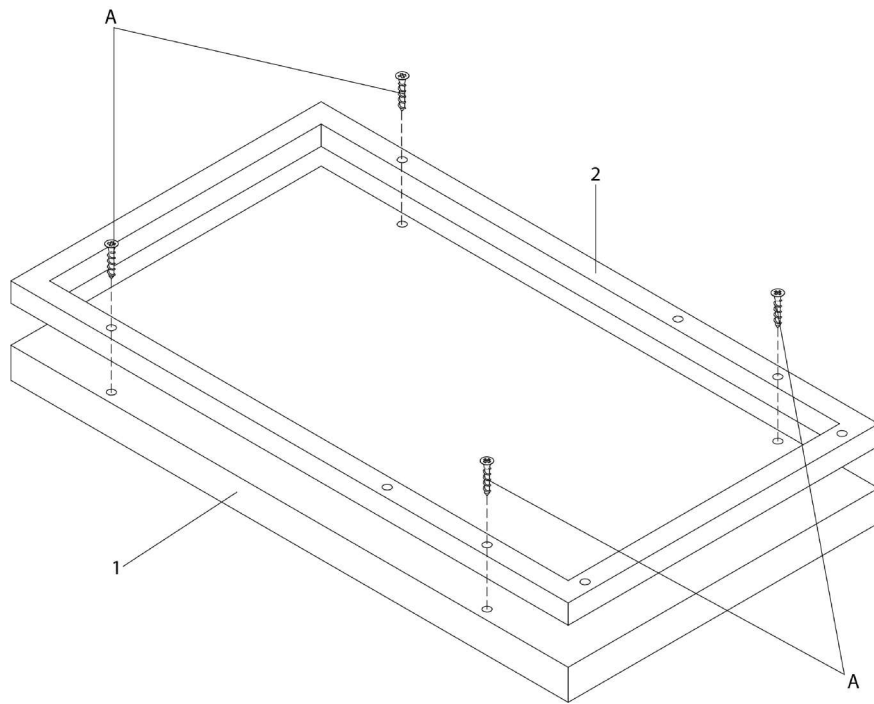

ÉTAPE / STEP 2

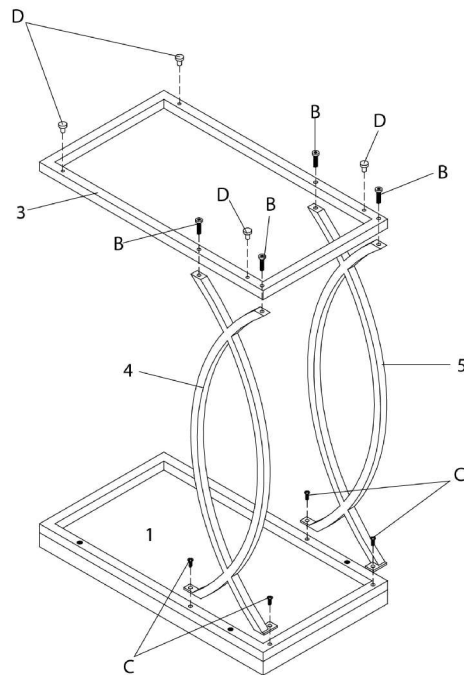

ÉTAPE / STEP 3

