



INSTRUCTIONS D'ASSEMBLAGE
ASSEMBLY INSTRUCTIONS

MONARCH
SPECIALTIES INC.

I 3204

TABLE D'APPOINT -
METAL CHROME / NATUREL ET TIROIR

ACCENT TABLE -
CHROME METAL / NATURAL WITH A DRAWER



**POUR DE L'ASSISTANCE OU POUR COMMANDER
DES PIÈCES CONTACTEZ NOTRE DÉPARTEMENT
DE SERVICE À LA CLIENTÈLE.**

**FOR ASSISTANCE OR TO ORDER PARTS
CONTACT OUR CUSTOMER SERVICE DEPARTMENT**

WWW.MONARCHSERVICE.COM

LISTE DES PIÈCES
PARTS LIST

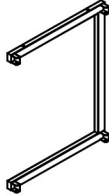
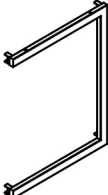
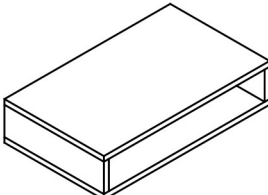
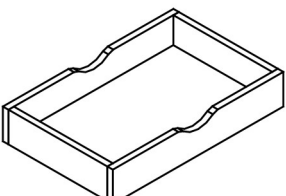
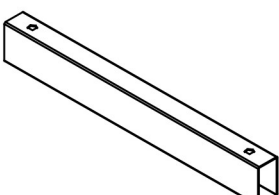
PIÈCE / PART #	IMAGE	DESCRIPTION	QTY / QTÉ
1		FRONT FACING LEFT LEG PATTE AVANT GAUCHE	1
2		FRONT FACING RIGHT LEG PATTE AVANT DROITE	1
3		TABLE TOP SURFACE DE TABLE	1
4		DRAWER TIROIR	1
5		STRETCHER CHÂSSIS	4

LISTE DES PIÈCES DE MONTAGE
HARDWARE LIST

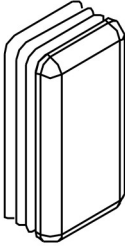
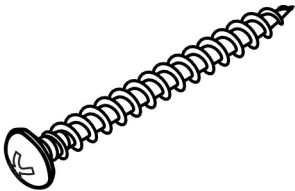
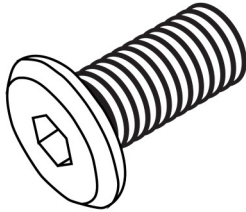
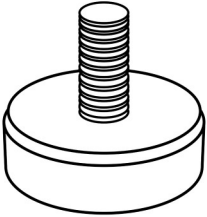
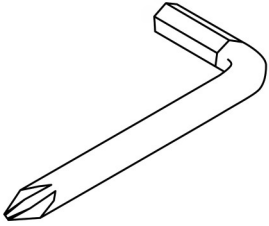
PIÈCE / PART #	IMAGE	DESCRIPTION	QTY / QTÉ
A		CAP - 1/2" X 1" CAPUCHON - 1/2" X 1"	4
B		ASSEMBLING SCREW - Ø1/8" X 1 3/8" VIS D'ASSEMBLAGE - Ø1/8" X 1 3/8"	4
C		ASSEMBLING BOLT - Ø1/4" X 1/2" BOULON D'ASSEMBLAGE - Ø1/4" X 1/2"	8
D		ADJUSTABLE LEG - Ø1/4" X 3/8" PATTE AJUSTABLE - Ø1/4" X 3/8"	4
E		HEX KEY CLÉ HEXAGONALE	1

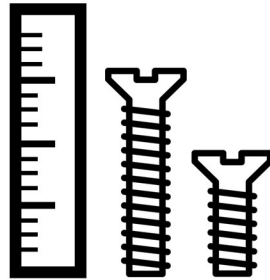

OUTIL DE VÉRIFICATION DE DIMENSIONS DES PIÈCES
HARDWARE DIMENSIONS VERIFICATION TOOL

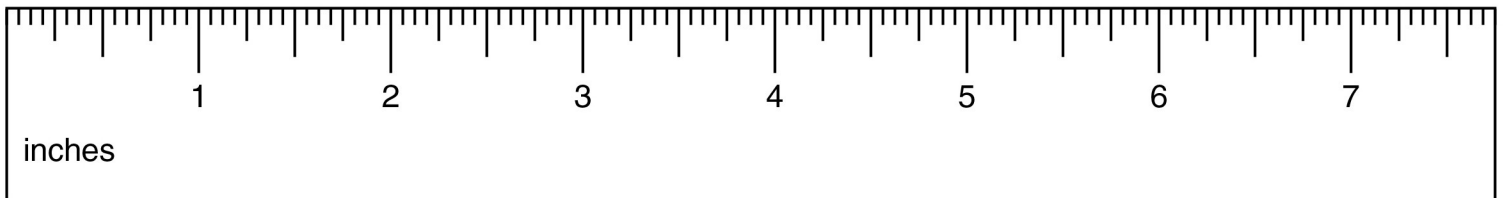

ÉTAPE / STEP 1

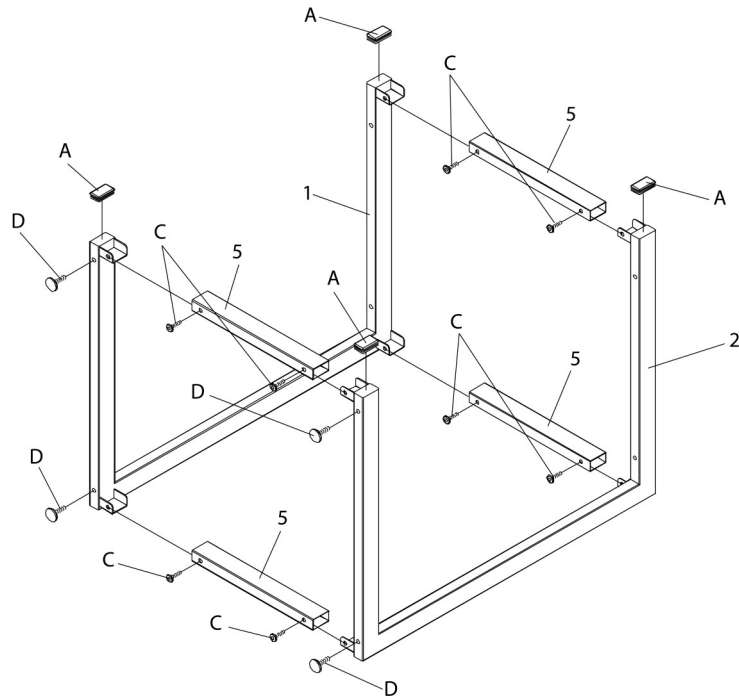

ÉTAPE / STEP 2

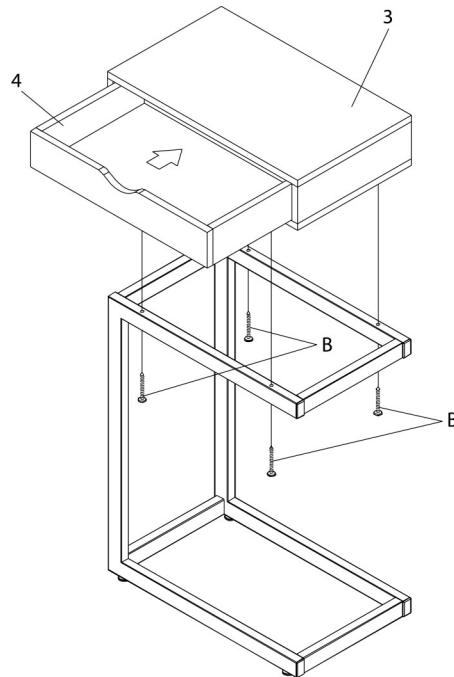

ÉTAPE / STEP 3

