



INSTRUCTIONS D'ASSEMBLAGE
ASSEMBLY INSTRUCTIONS

MONARCH
SPECIALTIES INC.

I 3240

TABLE D'APPOINT -
OVALE / CHROME / VERRE TREMPE GIVRE

ACCENT TABLE -
OVAL / CHROME / FROSTED TEMPERED GLASS



**POUR DE L'ASSISTANCE OU POUR COMMANDER
DES PIÈCES CONTACTEZ NOTRE DÉPARTEMENT
DE SERVICE À LA CLIENTÈLE.**

**FOR ASSISTANCE OR TO ORDER PARTS
CONTACT OUR CUSTOMER SERVICE DEPARTMENT**

WWW.MONARCHSERVICE.COM

LISTE DES PIÈCES
PARTS LIST

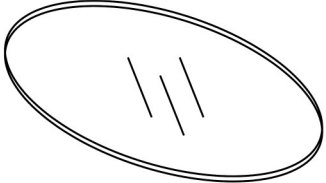
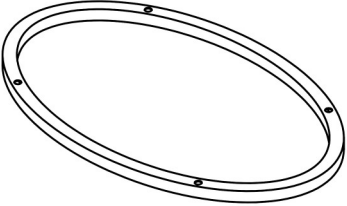
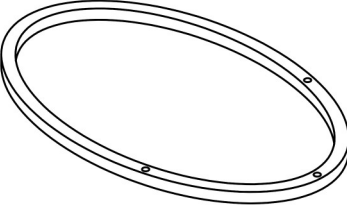
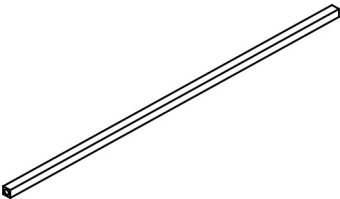
PIÈCE / PART #	IMAGE	DESCRIPTION	QTY / QTÉ
1		<p align="center">GLASS TOP SURFACE EN VERRE</p>	1
2		<p align="center">TOP FRAME CADRE DE SURFACE</p>	1
3		<p align="center">BOTTOM FRAME CADRE DU BAS</p>	1
4		<p align="center">SUPPORT BAR BARRE DE SOUTIEN</p>	3

LISTE DES PIÈCES DE MONTAGE
HARDWARE LIST

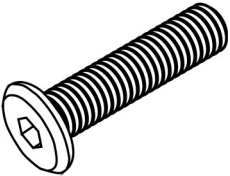
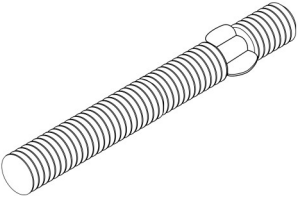
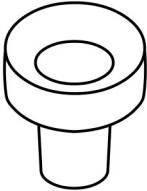
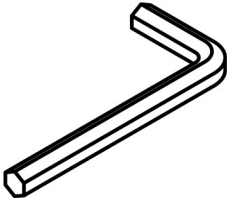
PIÈCE / PART #	IMAGE	DESCRIPTION	QTY / QTÉ
A		<p>SUCTION CUP - Ø1/2" X 1/2"</p> <p>VENTOUSE - Ø1/2" X 1/2"</p>	4
B		<p>ASSEMBLING BOLT - Ø1/4" X 1 1/4"</p> <p>BOULON D'ASSEMBLAGE - Ø1/4" X 1 1/4"</p>	3
C		<p>THREADED ROD - Ø1/4" X 1"</p> <p>TIGE FILETÉE - Ø1/4" X 1"</p>	3
D		<p>CLEAR BUMPER - Ø1/2" X 1/2"</p> <p>COUSSINET TRANSPARENT - Ø1/2" X 1/2"</p>	4
E		<p>HEX KEY</p> <p>CLÉ HEXAGONALE</p>	1

LISTE DES PIÈCES DE MONTAGE
HARDWARE LIST

PIÈCE / PART #	IMAGE	DESCRIPTION	QTY / QTÉ
F		SPANNER CLÉ ANGLAISE	1

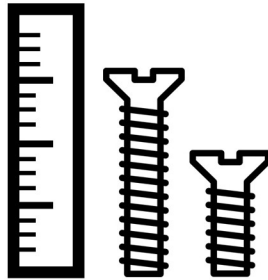

OUTIL DE VÉRIFICATION DE DIMENSIONS DES PIÈCES
HARDWARE DIMENSIONS VERIFICATION TOOL

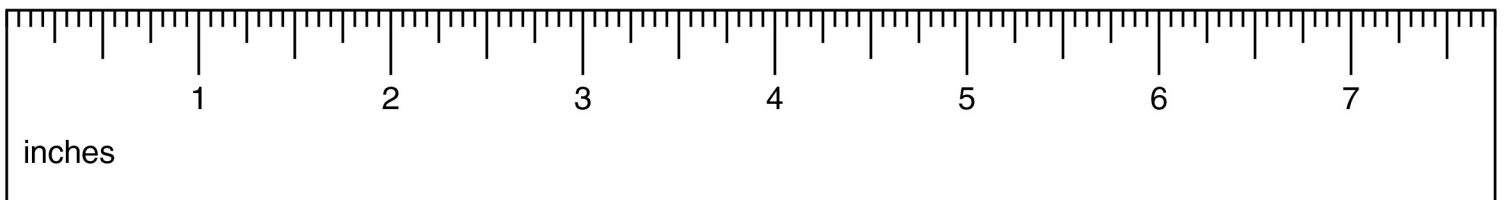

ÉTAPE / STEP 1

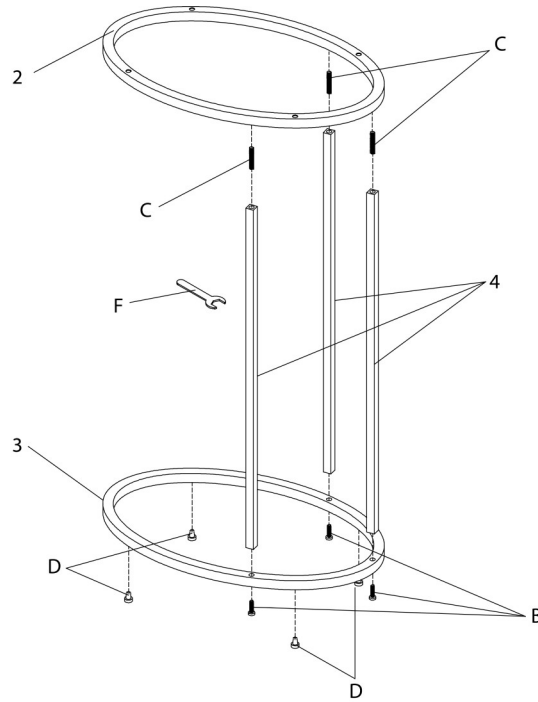

ÉTAPE / STEP 2

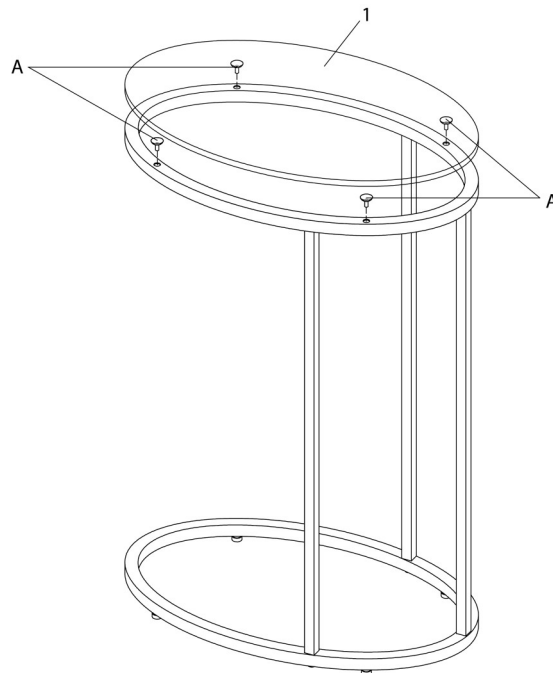

ÉTAPE / STEP 3

