



INSTRUCTIONS D'ASSEMBLAGE  
ASSEMBLY INSTRUCTIONS

---

**M**ONARCH  
SPECIALTIES INC.

# I 3396

---

TABLE DE BOUT / NICKEL NOIR / DESSUS MIROIR

END TABLE -  
BLACK NICKEL METAL / MIRROR TOP



POUR DE L'ASSISTANCE OU POUR COMMANDER  
DES PIÈCES CONTACTEZ NOTRE DÉPARTEMENT  
DE SERVICE À LA CLIENTÈLE.

FOR ASSISTANCE OR TO ORDER PARTS  
CONTACT OUR CUSTOMER SERVICE DEPARTMENT

[WWW.MONARCHSERVICE.COM](http://WWW.MONARCHSERVICE.COM)

---

**LISTE DES PIÈCES**  
**PARTS LIST**

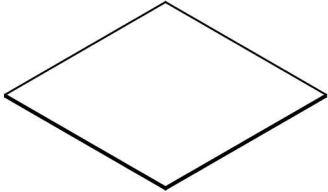
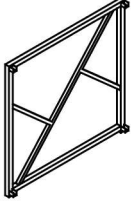
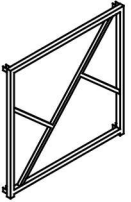
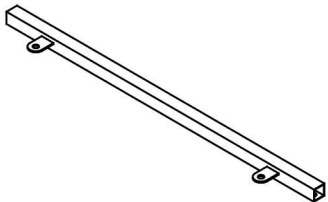
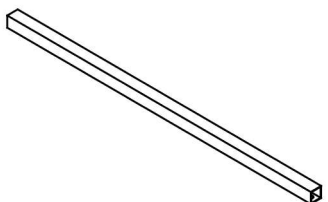
PIÈCE / PART #	IMAGE	DESCRIPTION	QTY / QTÉ
1		MIRROR TOP MIRROR TOP	1
2		METAL LEG PATTE EN METAL	1
3		METAL LEG PATTE EN METAL	1
4		CROSSBAR BARRE TRANSVERSALE	2
5		CROSSBAR BARRE TRANSVERSALE	2

**LISTE DES PIÈCES DE MONTAGE**  
**HARDWARE LIST**

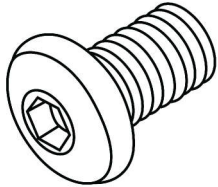
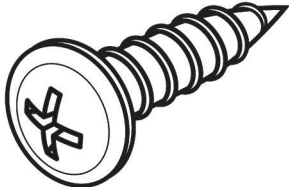
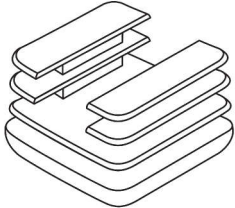
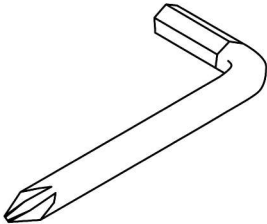
PIÈCE / PART #	IMAGE	DESCRIPTION	QTY / QTÉ
A		<p align="center">ASSEMBLING BOLT - Ø1/4" X 1/2"</p> <p align="center">BOULON D'ASSEMBLAGE - Ø1/4" X 1/2"</p>	12
B		<p align="center">ASSEMBLING SCREW - Ø1/2" X 3/8"</p> <p align="center">VIS D'ASSEMBLAGE - Ø1/2" X 3/8"</p>	4
C		<p align="center">FLOOR PROTECTOR - 3/4" X 3/4"</p> <p align="center">PROTECTEUR DE PLANCHER - 3/4" X 3/4"</p>	4
D		<p align="center">HEX KEY</p> <p align="center">CLÉ HEXAGONALE</p>	1

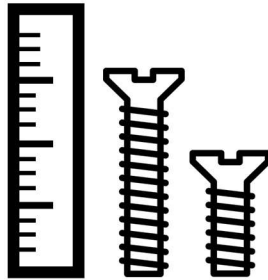

OUTIL DE VÉRIFICATION DE DIMENSIONS DES PIÈCES  
HARDWARE DIMENSIONS VERIFICATION TOOL

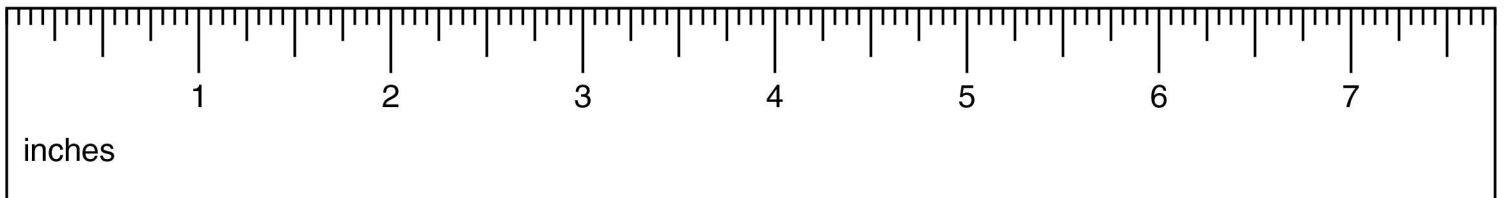

ÉTAPE / STEP 1

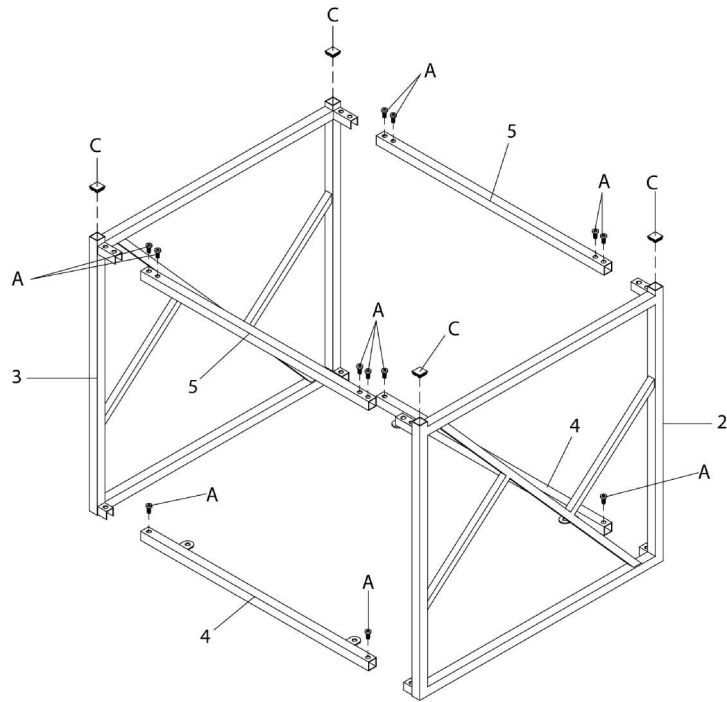

ÉTAPE / STEP 2

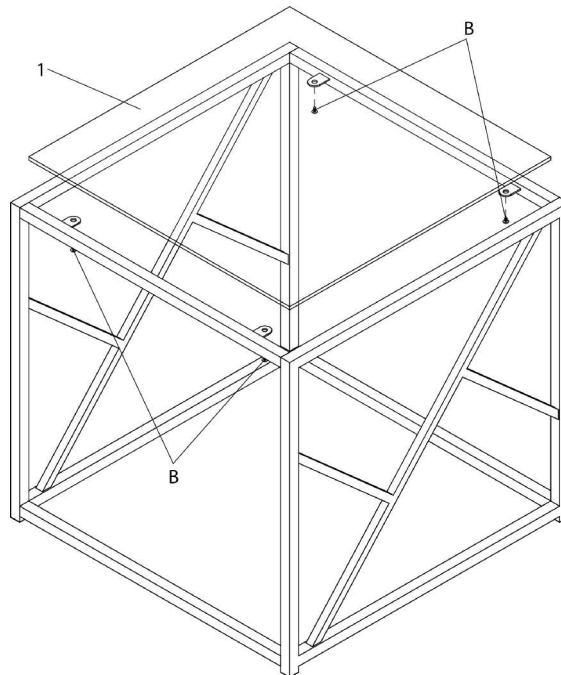

ÉTAPE / STEP 3

