



**INSTRUCTIONS D'ASSEMBLAGE**  
**ASSEMBLY INSTRUCTIONS**

---

**MONARCH**  
SPECIALTIES INC.

**I 3287**

---

**TABLES GIGOGNES -**  
**ENS. 2PCS / BLANC LUSTRE / VERRE TREMPE**

**NESTING TABLE -**  
**2PCS SET / GLOSSY WHITE / TEMPERED GLASS**



**POUR DE L'ASSISTANCE OU POUR COMMANDER**  
**DES PIÈCES CONTACTEZ NOTRE DÉPARTEMENT**  
**DE SERVICE À LA CLIENTÈLE.**

**FOR ASSISTANCE OR TO ORDER PARTS**  
**CONTACT OUR CUSTOMER SERVICE DEPARTMENT**

**[WWW.MONARCHSERVICE.COM](http://WWW.MONARCHSERVICE.COM)**

---

**LISTE DES PIÈCES**  
**PARTS LIST**

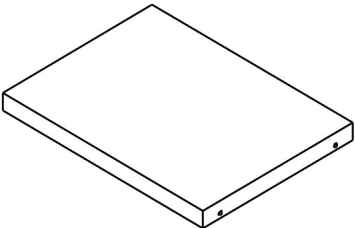
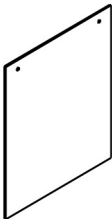
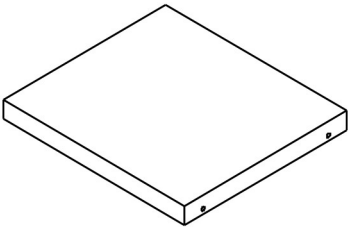
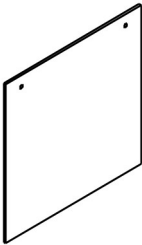
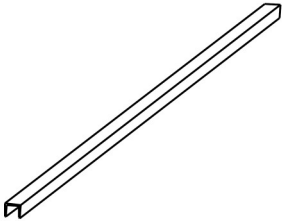
PIÈCE / PART #	IMAGE	DESCRIPTION	QTY / QTÉ
1		TABLE TOP (LARGE) DESSUS DE TABLE (GRAND)	1
2		GLASS PANEL (LARGE) PANNEAU EN VERRE (GRAND)	2
3		TABLE TOP (SMALL) DESSUS DE TABLE (PETIT)	1
4		GLASS PANEL (SMALL) PANNEAU EN VERRE (PETIT)	2
5		PLASTIC BAR (LONG) BARRE EN PLASTIQUE (LONG)	2

**LISTE DES PIÈCES**  
**PARTS LIST**

PIÈCE / PART #	IMAGE	DESCRIPTION	QTY / QTÉ
6		PLASTIC BAR (SHORT) BARRE EN PLASTIQUE (COURT)	2

**LISTE DES PIÈCES DE MONTAGE**  
**HARDWARE LIST**

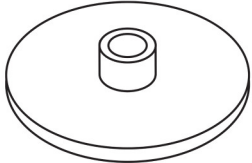
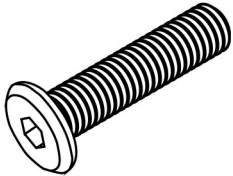
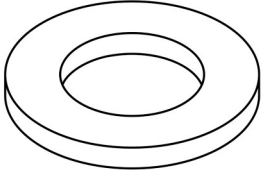
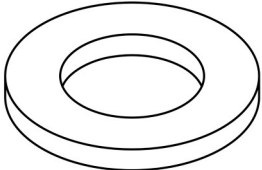
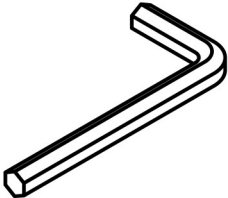
PIÈCE / PART #	IMAGE	DESCRIPTION	QTY / QTÉ
<b>A</b>		CAP - Ø1/4" X 1 3/8"  CAPUCHON - Ø1/4" X 1 3/8"	<b>8</b>
<b>B</b>		ASSEMBLING BOLT - Ø1/4" X 1 7/8"  BOULON D'ASSEMBLAGE - Ø1/4" X 1 7/8"	<b>8</b>
<b>C</b>		PLASTIC WASHER - Ø3/8"  RONDELLE DE PLASTIQUE - Ø3/8"	<b>16</b>
<b>D</b>		METAL WASHER - Ø1/4"  RONDELLE DE MÉTAL - Ø1/4"	<b>8</b>
<b>E</b>		HEX KEY  CLÉ HEXAGONALE	<b>1</b>



OUTIL DE VÉRIFICATION DE DIMENSIONS DES PIÈCES  
HARDWARE DIMENSIONS VERIFICATION TOOL

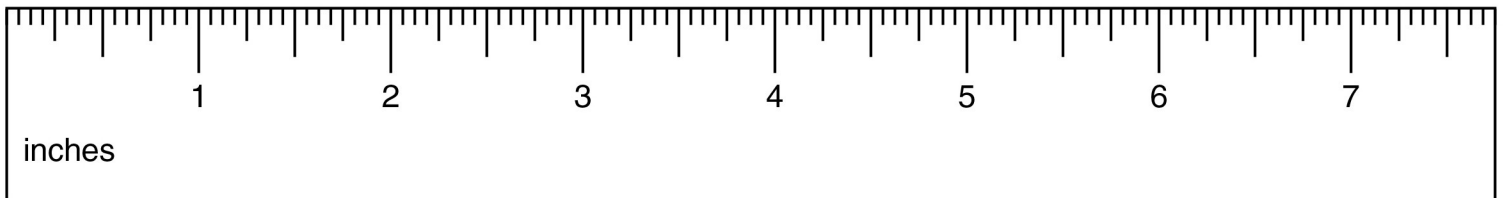

ÉTAPE / STEP 1

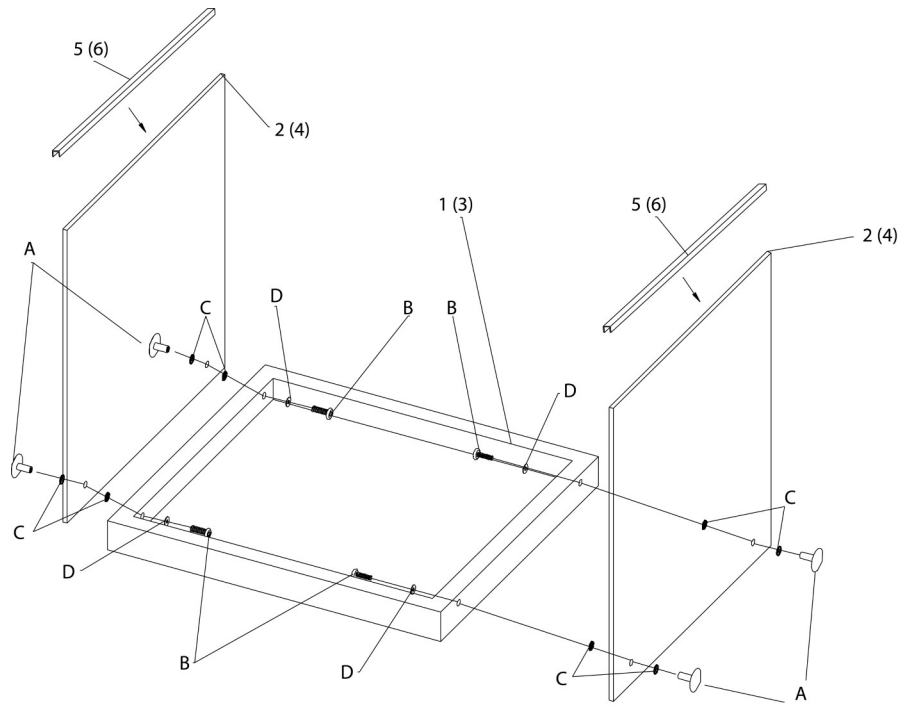

ÉTAPE / STEP 2

