

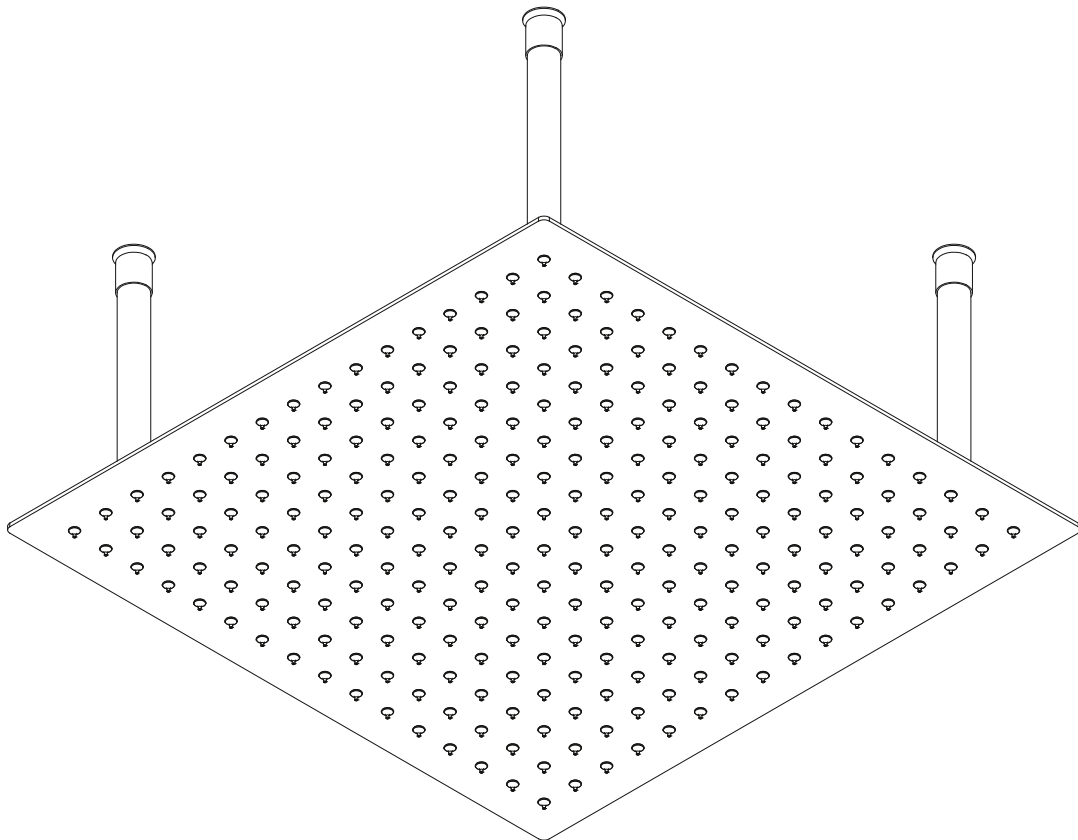

SHOWER HEAD INSTALLATION INSTRUCTION



Parts List

Ax1

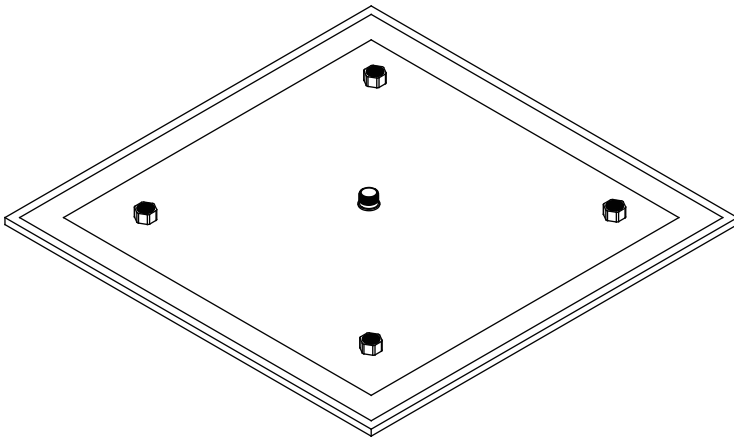

Bx1

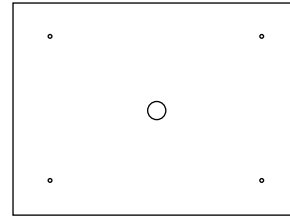

Template not included, create your own if needed.

Cx4



D 1 x4

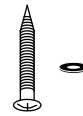

D 2 x4



Ex4



Fx1



You Will Need The Following Tools

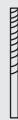
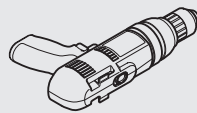
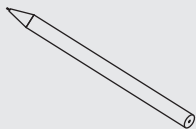

Ø6mm

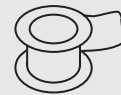
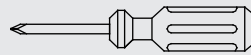

According to drilling drawing sheet to (B) mark the 4 drilling positions ①, then use the $\text{\O}6\text{mm}$ drill to drill holes on the wall according to the marked hole position.

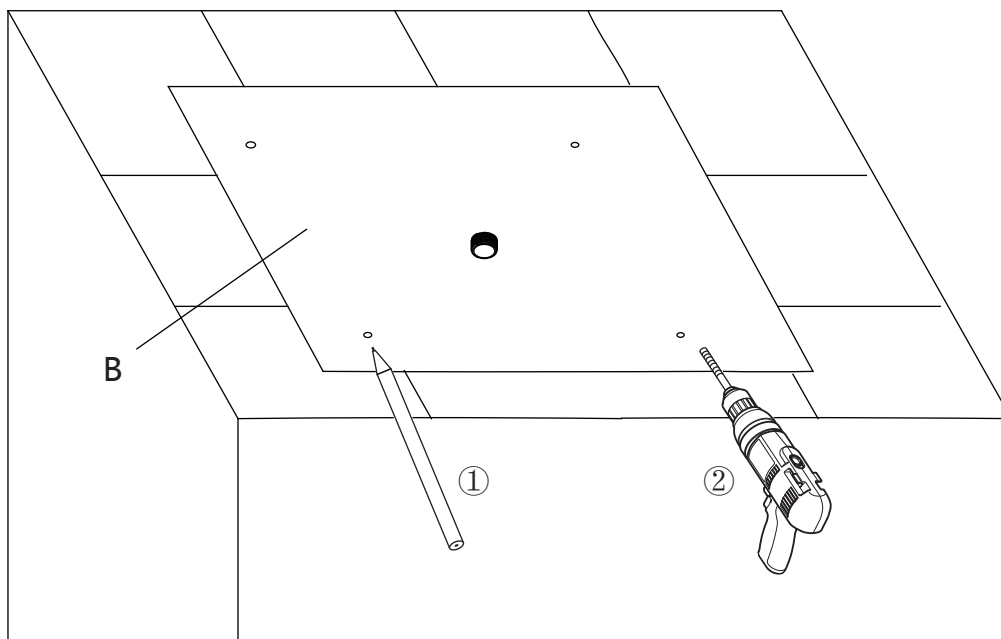

Inset the plug (D2) into the hole, hold the fix base (C) use the tapping screw (D1) through fix base (C) holes, tighten the tapping screw (D1) tighten the top shower fixed bar (E) and the inlet hose (F) with the fix base (C)

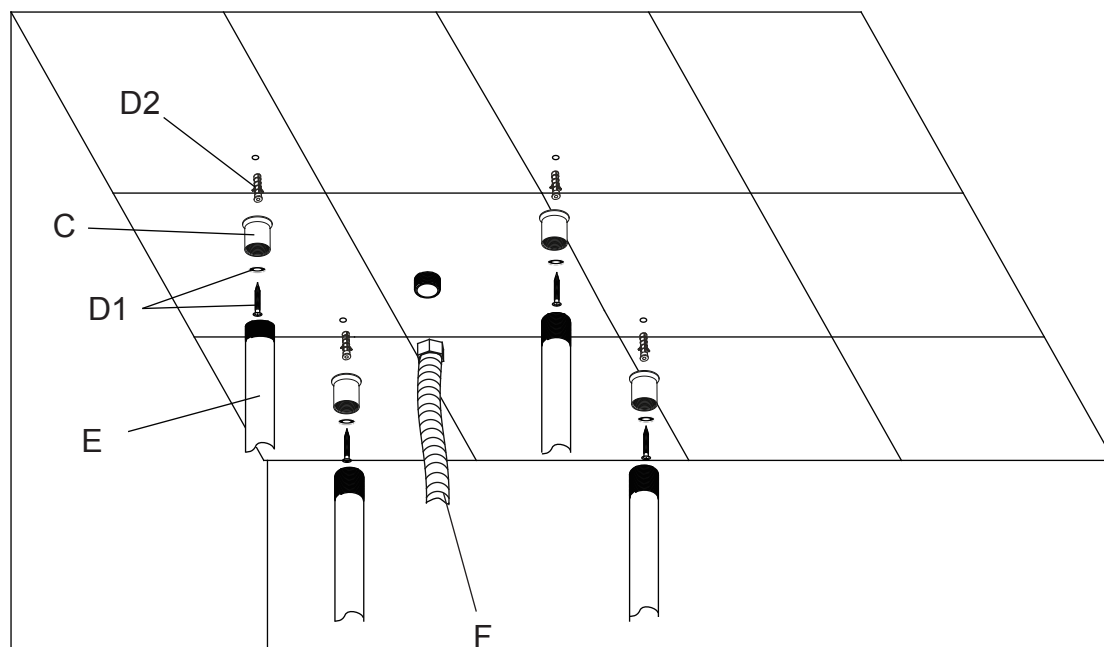

Fixed the top shower with the top shower fixed bar (E) , then connect with the inlet hose (F) .

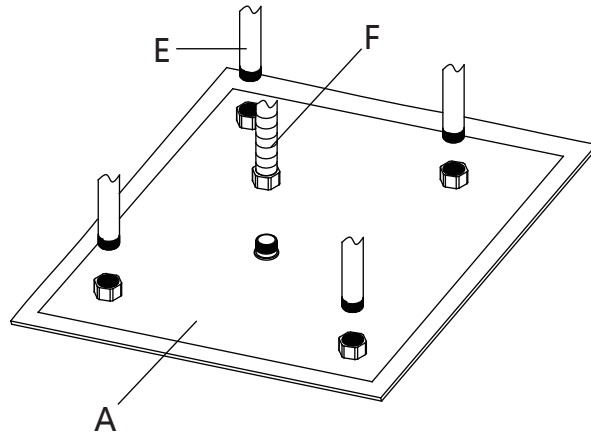

The installation is completed.

