

WARNING! - ACHTUNG! - UWAGA! - AVERTISSEMENT!

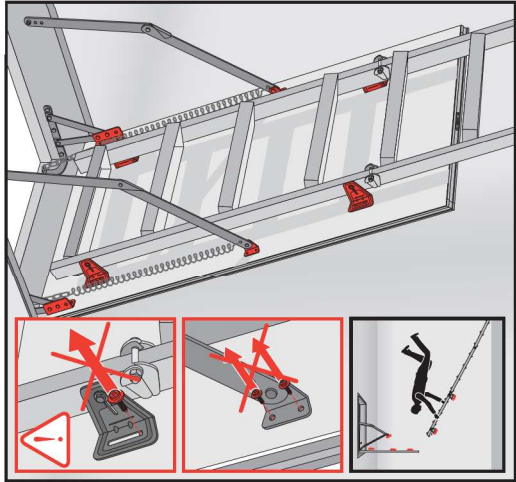

www.fakro.com

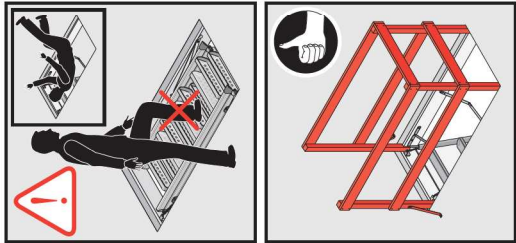
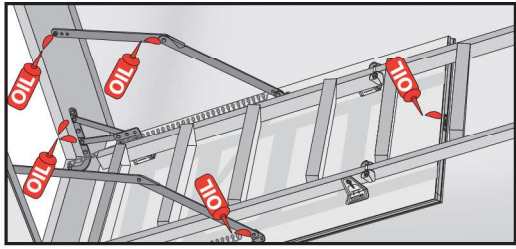

EN 14975 : 2006

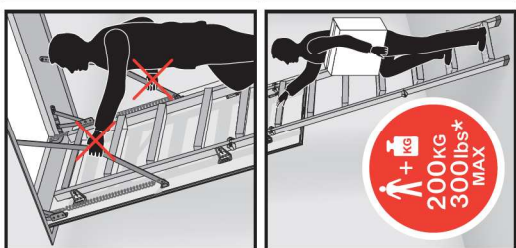
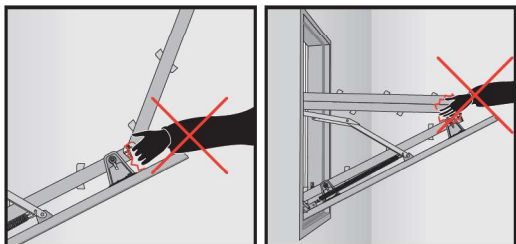

*ANSI 14.9 - 2004

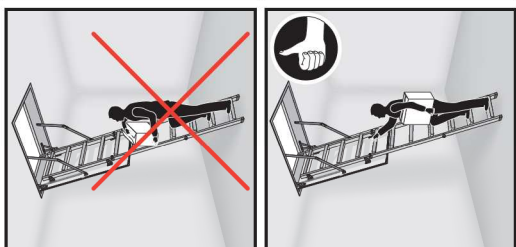

FAKRO®

LMS



LMK



NC 99G

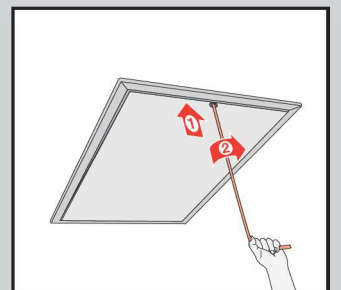
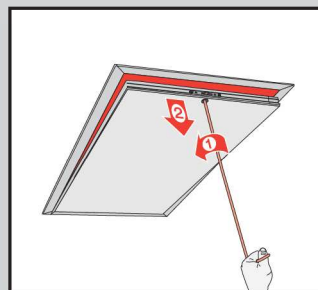

CZ	Výrobce a Prodejce nenesí žádnou odpovědnost za nedodržení příslušných předpisů zákona, stavebních předpisů a bezpečnostních požadavků plus uživatele výrobku, architekta, montéra nebo majitele objektu.	I	Il Produttore e il Rivenditore non potranno essere ritenuti responsabili per il mancato rispetto, da parte dell'utente del prodotto, del progettista, dell'installatore o del proprietario dell'edificio, delle leggi vigenti, nonché dei regolamenti edilizi e di quelli relativi alla sicurezza.
D	Hersteller und Verkäufer übernehmen keine Haftung für Nichtbeachtung entsprechender Rechts- und Bauvorschriften sowie Sicherheitsanforderungen seitens Produktbenutzer, Architekten, Monteure oder Gebäudebesitzer.	NL	De fabrikant en verkoper zijn niet aansprakelijk voor gevolgen bij het niet opvolgen van toepasselijke wetten, bouwbesluiten en veiligheidsvoorschriften door de gebruiker van het product, de architect, de installateur of de eigenaar van het gebouw.
E	El fabricante y el vendedor no tienen ninguna responsabilidad por el incumplimiento de la ley vigente, normas de construcción y exigencias de seguridad por parte del usuario del producto, arquitecto, instalador o el propietario del edificio.	PL	Producent i Sprzedawca nie ponosi żadnej odpowiedzialności za nieprzestrzeganie stosowanych przepisów prawa, przepisów budowlanych i wymogów bezpieczeństwa przez użytkownika produktu, architekta, montażystę lub właściciela budynku.
FR	Le fabricant et le vendeur ne prend aucune responsabilité de ne pas respecter les lois applicables, les règlements sur les bâtiments et les exigences de sécurité par l'utilisateur du produit, l'architecte, l'installateur ou le propriétaire du bâtiment.	RU	Нич производитель, ни дистрибутор не тьи vor аsuma мичун fel de răspundere pentru nerespectarea legilor în vigoare, a legilor din domeniul construcțiilor sau a măsurilor de siguranță impuse utilizatorilor produsului, arhitecților, montajorilor sau proprietarilor clădirii.
GB	Manufacturer and Seller shall bear no liability for failure to comply with the applicable laws, building codes and safety requirements by the user of the product, architect, fitter or owner of the building.	RUS	В случае несоблюдения строительных, монтажных или владельцев здания строительных правил и норм безопасности ответственность с производителя и продавца снимается.
H	A Gyártó és a Forgalmazó nem vállal semmilyen felelősséget a vonatkozó törvényi, építési és biztonsági előírások terjedélteljesülése, építész, beszerelőmester vagy épületlajdos által be nem tartásáért.	SK	Výrobca a predajca nenesí žiadnu zodpovednosť za nedodržanie príslušných ustanovení zákona, stavebných predpisov a bezpečnostných požiadaviek užívateľom výrobku, architektom, montérom alebo majiteľom objektu.

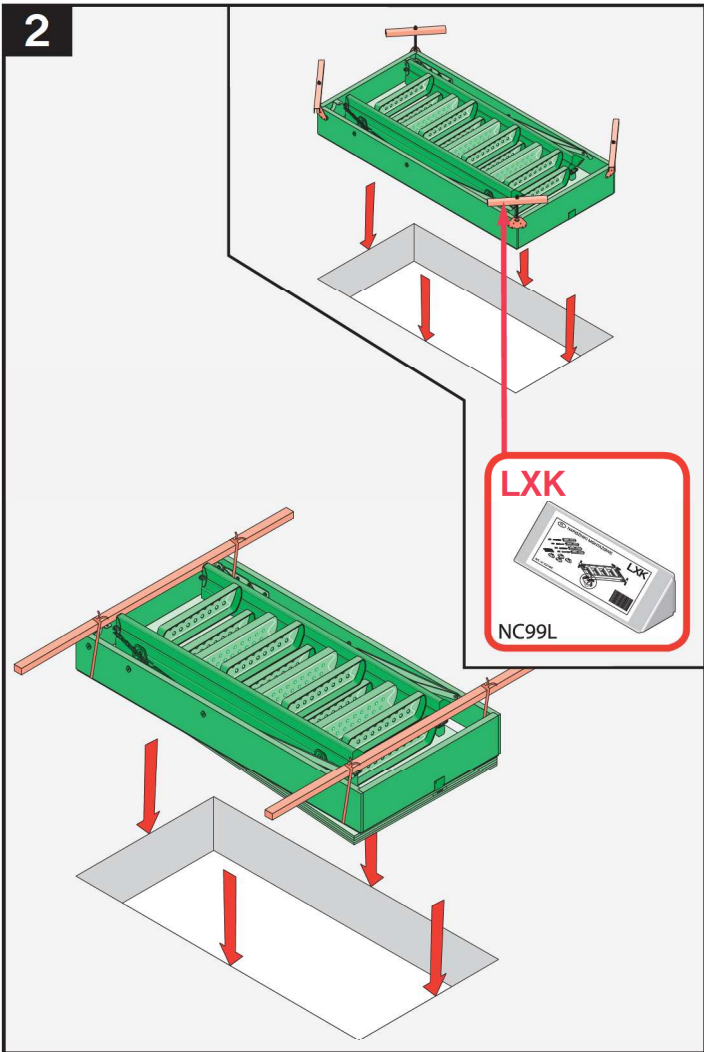
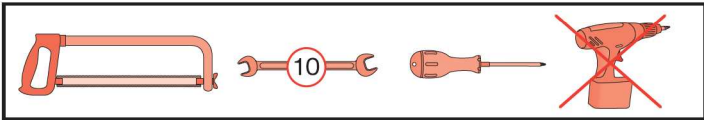
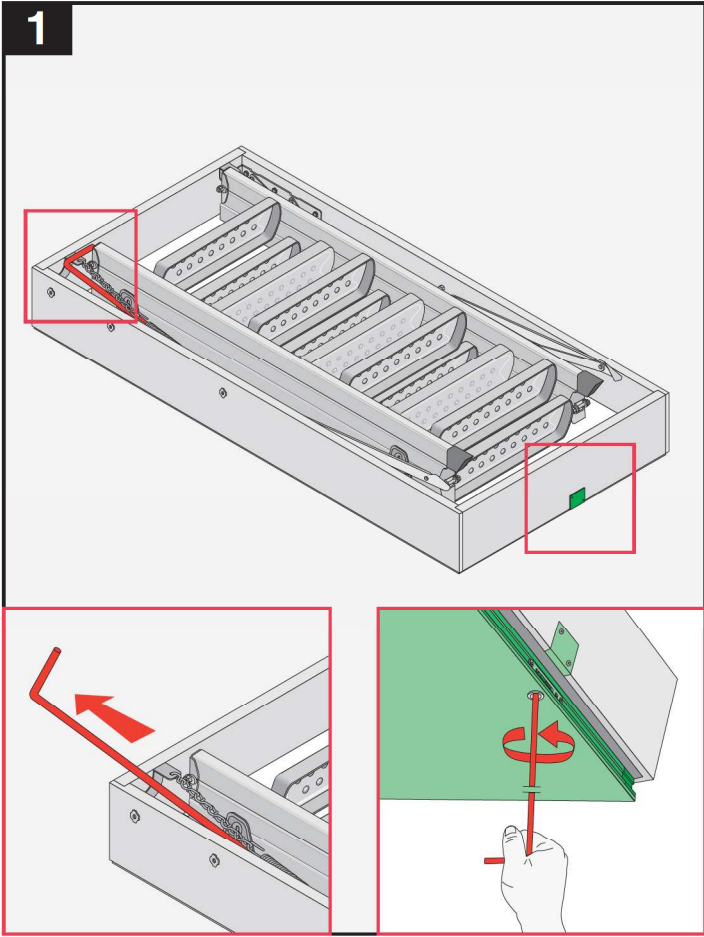

2

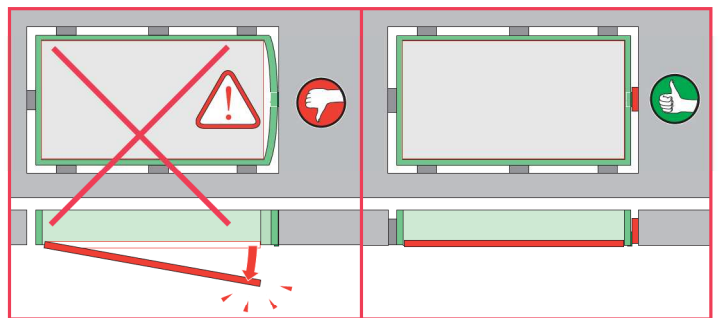
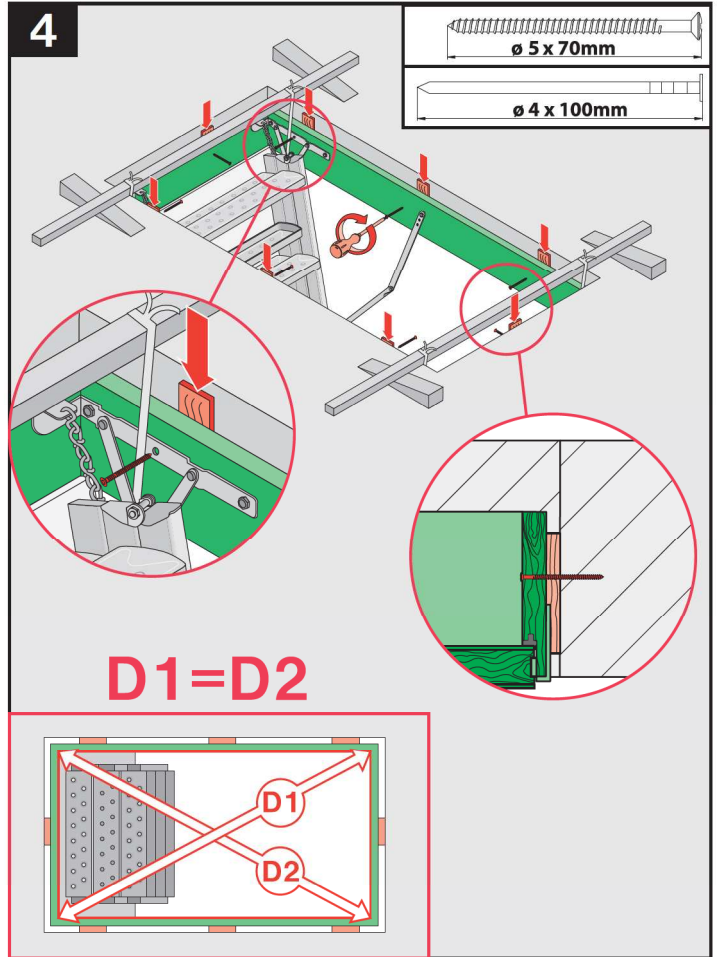
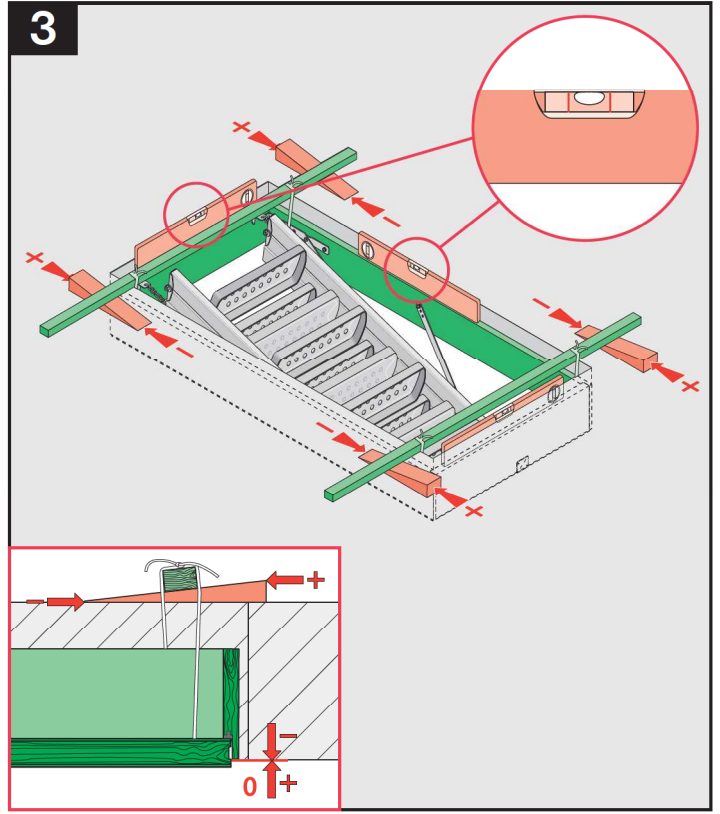

3

