

C R O S L E Y
F U R N I T U R E

Schoolhouse Bar Stool

CF500324/500330

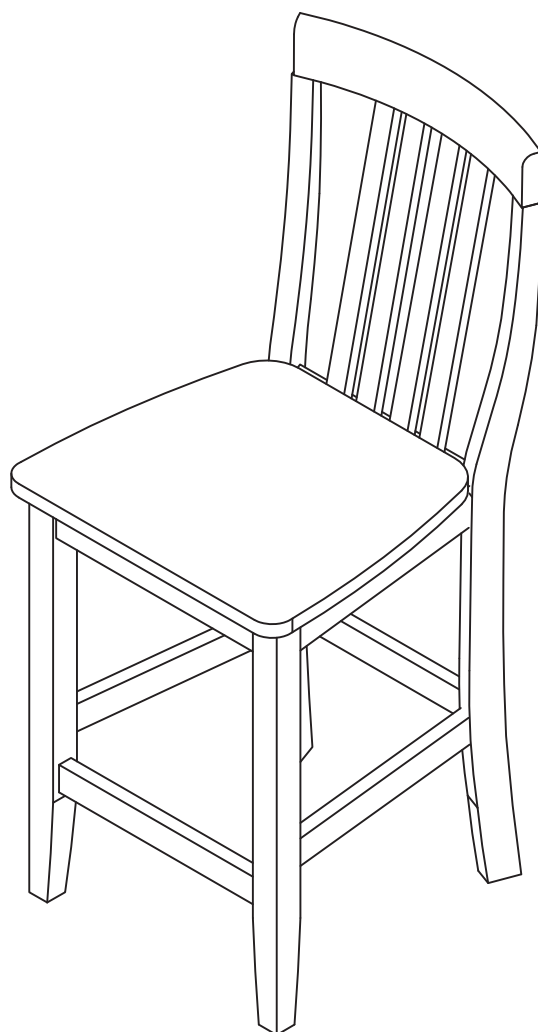

C R O S L E Y
F U R N I T U R E

Congratulations! You have purchased a stylish piece of Crosley Furniture. We strive to provide fine furniture products, built with quality materials and hand finished details. Please carefully follow the assembly instructions to ensure your furniture is assembled correctly to provide long lasting enjoyment.

Please note, the assembly hardware is located in a plastic bag that is attached to the underside of the seat bottom.





Should you experience any missing or damaged parts, **do not return to the store.** Please contact us directly at 800-815-4796.







Care: Use a soft clean cloth that will not scratch the surface when dusting. Use of furniture polish is not necessary. Should you choose to use polishes, test in an inconspicuous area first. Use of solvents of any kind may damage your furniture's finish. To clean, simply use a soft clean cloth moistened with lukewarm water, then buff with a dry soft clean cloth.

ASSEMBLY INSTRUCTIONS

ITEM#: CF500424/500430

DESCRIPTION: 24 "/30" Schoolhouse Back Bar Stool

Part Lists			
No.	Description	Sketch	Q'ty
A	BACK FRAME		1 PC
B	SEAT FRAME		1 PC
C	FRONT LEG (RIGHT AND LEFT)		1 PAIR
D	SIDE STRETCHER (RIGHT AND LEFT)		1 PAIR
E	FRONT STRETCHER		1 PC

Hardware Lists			
No.	Description	Sketch	Q'ty
a	LONG BOLT (5/16 x 80")		4 PCS
b	BOLT (5/16 x 60")		4 PCS
c	SHORT BOLT (5/16 x 40")		3 PCS
d	SPRING WASHER		11 PCS
e	FLAT WASHER		11 PCS
f	ALLEN WRENCH		1 PC
g	SCREW(#8X1-1/2")		6 PCS

Step 1

Attach seat frame (B) to the back frame (A) using long bolts (a), short bolts (c), spring washers (d), and flat washers (e) as shown in Figure 1. Three short bolts (c) will be used in the center of the seat frame. The four long bolts (a) will be used on the back corners of the seat frame.

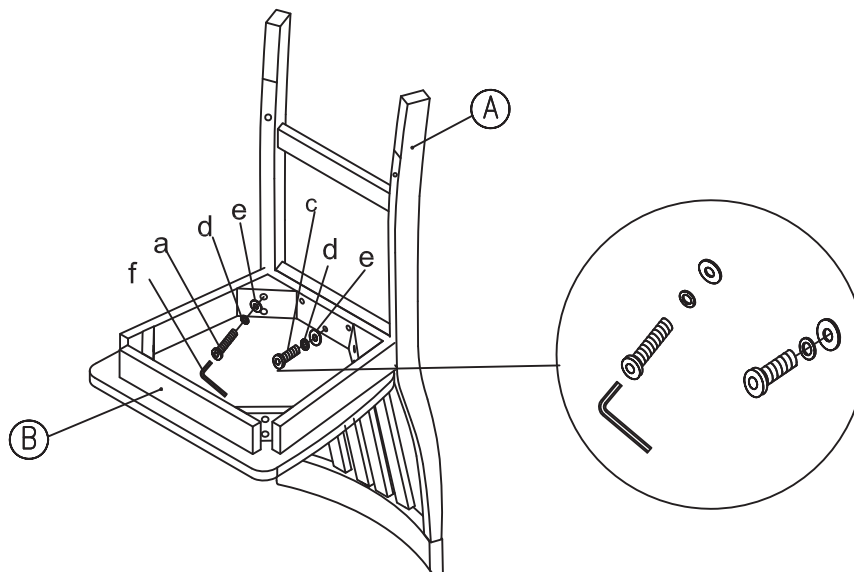

Step 2

Attach left and right front legs (C) to the seat frame (B) using the bolts (b), spring washers (d) and flat washers (e) as shown in Figure 2. **Do not tighten bolts at this time.**

Note: The left and right front legs (C) are marked "R" & "L".

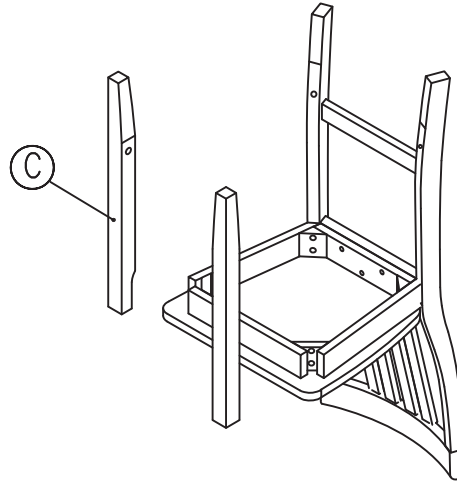

Step 3

Insert the left and right side stretchers (D) into the back frame legs (A) and the front legs (C). Insert the front stretcher (E) into the front legs (C) as shown in Figure 3.

Note: If you have trouble inserting the stretchers, loosen the bolts (b) slightly to allow for extra space. The side stretchers (D) are marked "R" & "L".

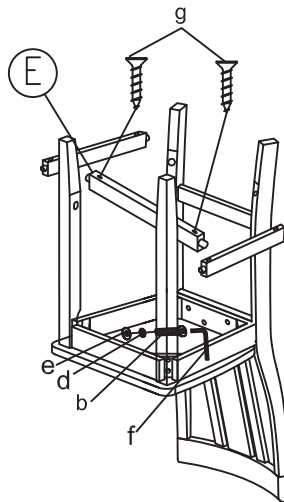

Step 4

Ensure that the side stretchers (D) are flush with back frame (A) and front legs (C). Secure with screws (g) using Phillips head screw driver. Repeat this step, securing the front stretcher (E) to the front legs (C). Finger-tighten the bolts (b).

Step 5

Turn stool upright on its legs and place on a flat, level floor. Make sure that the stool is level and square. Tighten all bolts (a, b and c) completely with supplied Allen wrench (f).

C R O S L E Y
F U R N I T U R E

Limited Manufacturers Warranty

Crosley Furniture Products are warranted against defects in material and workmanship for a period of 90 days beginning from the date of sale. Should any parts be missing or defective, we will replace or repair the parts for a period of 90 days from the date of purchase.

Should you experience any missing or damaged parts, do not return to the store. Please contact us directly at 800-815-4796 from 9 AM to 5 PM (EST) Monday to Friday.

This warranty gives the purchaser specified legal rights in addition to any rights which may vary from state to state.

In accordance with the "Moss-Magnuson Warranty Act" of July 10, 1975, this is termed a "limited warranty" which in no way compromises Crosley Furniture's high standards of Quality and Workmanship.