



### Features

- Single-speed whirlpool offers performance and value, with 8 fully adjustable jets.
- Hydromassage flow and direction can be controlled at each jet.
- Comfort Depth® design offers a convenient 19-inch step-over height while retaining the same depth as a standard 21-inch bath.
- Molded lumbar support offers extra comfort while bathing.
- Slotted overflow allows for deep soaking.
- Integral flange helps prevent water from seeping behind wall and simplifies alcove installation.
- Left-hand drain.
- Coordinates with other products in the Archer collection.



### Material

- Acrylic

### Hydrotherapy

- Whirlpool

### Installation

- Three-wall alcove.

### Required Accessories

K-7271 Brass Slotted Overflow Bath Drain

or

K-7272 PVC Slotted Overflow Bath Drain

### Recommended Accessories

K-24916 Wireless Music Kit

### ADA

### Codes/Standards

ASME A112.19.7/CSA B45.10

CSA B45.5/IAPMO Z124

UL 1598

CSA C22.2 No. 218.2

Greenguard UL 2818 - Gold

ADA

ICC/ANSI A117.1







### KOHLER® Hydrotherapy Components Five-Year Limited Warranty KOHLER® Plastic Baths and Receptors Lifetime Limited Warranty

See website for detailed warranty information.

### Available Color/Finishes

*Color tiles intended for reference only.*

#### Color Code Description

|  |    |           |
|--|----|-----------|
|  | 0  | White     |
|  | 96 | Biscuit   |
|  | 47 | Almond    |
|  | NY | Dune      |
|  | 95 | Ice™ Grey |
|  | G9 | Sandbar   |
|  | K4 | Cashmere  |

No change in measurements if connected with drain illustrated. (K-7272)

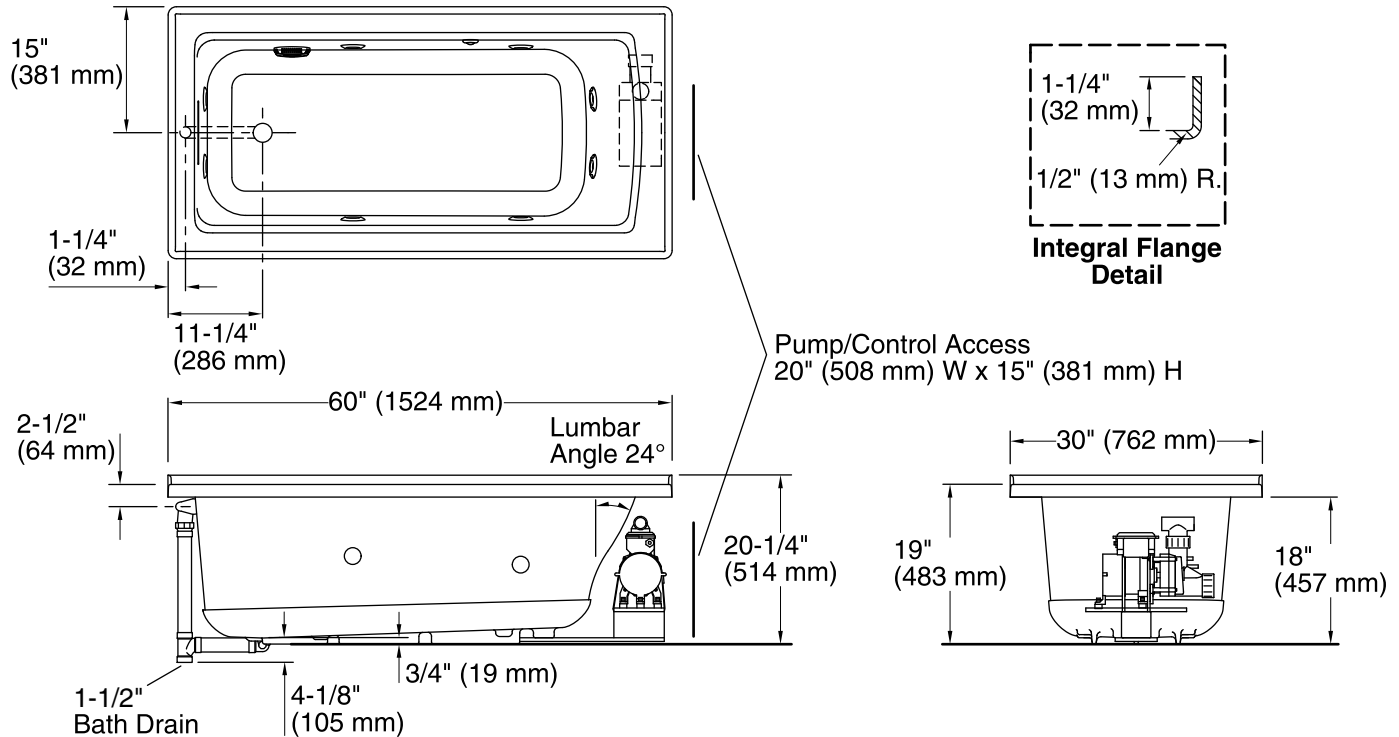

### Required Electrical Service

One dedicated circuit required, protected with Class A Ground-Fault Circuit-Interrupter (GFCI) or Residual Current Device (RCD).

Pump: 120 V, 15 A, 60 Hz

### Technical Information

All product dimensions are nominal.

Installation: Three-wall alcove  
 Drain location: Left  
 Basin area, bottom: 45-1/8" x 19-11/16" (1146 mm x 500 mm)  
 Basin area, top: 52-1/8" x 22-1/16" (1324 mm x 560 mm)  
 Weight: 98 lbs (44.5 kg)  
 Minimum floor load: 48 lbs/ft<sup>2</sup> (234.4 kg/m<sup>2</sup>)  
 Water depth: 15-1/8" (384 mm)  
 Water capacity: 57 gal (215.8 L)  
 Electrical component rating: Pump: 120 V, 7 A, 60 Hz  
 Pump speed: Single  
 Minimum flat for door: 2" (51 mm)

### Notes

Measure your actual product for rough-in details. Install this product according to the installation instructions. The hot water supply should be 70% of the capacity of the bath or greater. Installations will vary. ADA compliant when installed to the specific requirements of these regulations.