



Features

- 8 hydromassage jets can be individually adjusted for water flow and direction.
- Variable-speed pump for adjusting massage intensity.
- Built-in heater.
- Electronic keypad.
- Coordinates with other products in the Bancroft collection.

Material

- Acrylic

Hydrotherapy

- Whirlpool

Installation

- Drop-in

Required Accessories

K-9698 Flexjet® Whirlpool Trim Kit

Recommended Accessories

K-1491 Bath/Whirlpool Pillow
K-1601 Bath/Whirlpool Footstop
K-1703 Whirlpool Remote Control
K-7161-AF Bath Drain
K-9497 2-1/2" Keypad Trim
K-24916 Wireless Music Kit
K-7265 Clearflo Bath Drain
K-37382 45" Rough-in Cable Bath Drain



Codes/Standards

ASME A112.19.7/CSA B45.10
CSA B45.5/IAPMO Z124
ASTM E162
ASTM E662
UL 1795
Greenguard UL 2818 - Gold





**KOHLER® Plastic Baths and Receptors
Lifetime Limited Warranty
KOHLER® Hydrotherapy Components
Five-Year Limited Warranty**

See website for detailed warranty information.

Available Color/Finishes

Color tiles intended for reference only.

Color Code Description

	0	White
	96	Biscuit
	47	Almond
	NY	Dune
	G9	Sandbar

No change in measurements if connected with drain illustrated. (K-7161-AF)

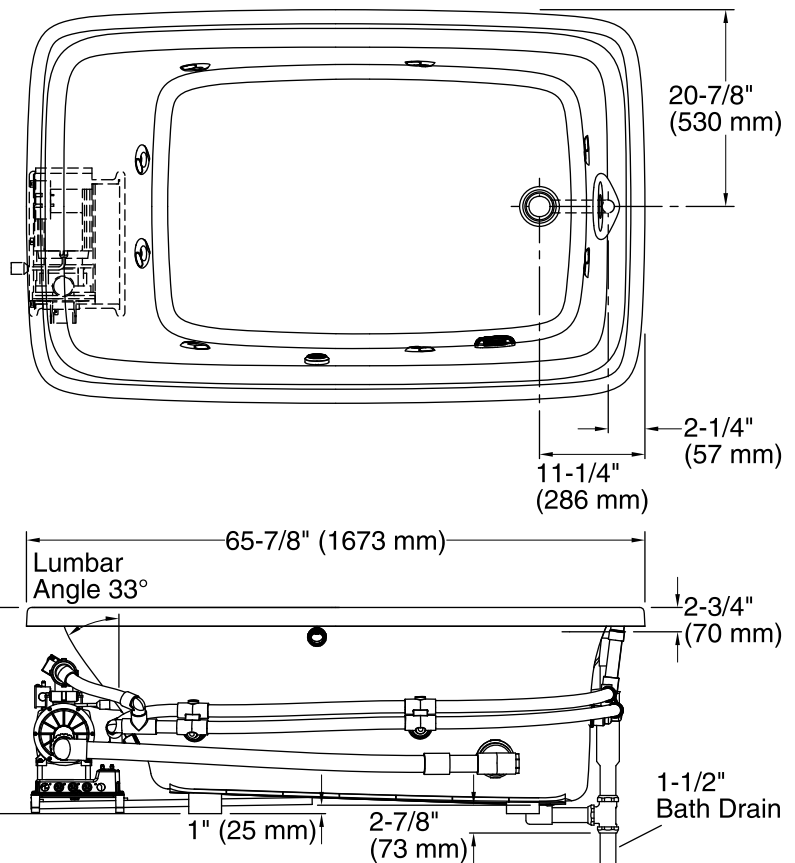
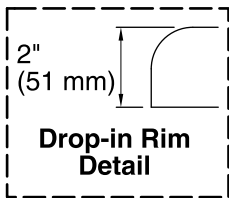

Pump/Control Access
34" (864 mm) W x
15" (381 mm) H

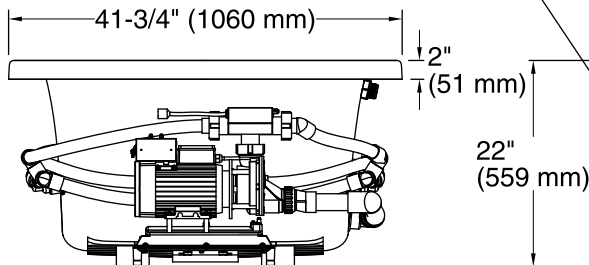

Required Electrical Service

One dedicated circuit required, protected with Class A Ground-Fault Circuit-Interrupter (GFCI) or Residual Current Device (RCD).

Pump, Heater: 240 V, 20 A, 50/60 Hz

Technical Information

All product dimensions are nominal.

Installation:	Drop-in
Drain location:	End
Basin area, bottom:	46" x 30" (1168 mm x 762 mm)
Basin area, top:	57" x 34" (1448 mm x 864 mm)
Weight:	130 lbs (59 kg)
Minimum floor load:	50 lbs/ft ² (244.1 kg/m ²)
Water depth:	16" (406 mm)
Water capacity:	95 gal (359.6 L)
Template:	Drop-in, 1043292-7, required, included
Electrical component rating:	Pump: 240 V, 11 A, 50/60 Hz Heater: 240 V, 6.25 A, 50/60 Hz, 1500 W
Pump speed:	Variable

Notes

Measure your actual product for rough-in details. Install this product according to the installation instructions.

The hot water supply should be 70% of the capacity of the bath or greater. Installations will vary.

This bath is designed for drop-in installation only. It is not suited for use in a three wall alcove with an overhead shower.