



Features

- Single-speed whirlpool offers performance and value, with 8 fully adjustable jets.
- Hydromassage flow and direction can be controlled at each jet.
- Built-in heater.
- Molded lumbar support offers extra comfort while bathing.
- Integral apron.
- Integral flange helps prevent water from seeping behind wall and simplifies alcove installation.
- Textured bottom surface
- Left-hand drain.
- Coordinates with other products in the Bancroft collection.

Material

- Acrylic

Hydrotherapy

- Whirlpool

Installation

- Three-wall alcove.

Recommended Accessories

K-11677 Bath Drain

K-24916 Wireless Music Kit



Codes/Standards

ASME A112.19.7/CSA B45.10

CSA B45.5/IAPMO Z124

ASTM E162

ASTM E662

UL 1795

Greenguard UL 2818 - Gold

KOHLER® Plastic Baths and Receptors Lifetime Limited Warranty





KOHLER® Hydrotherapy Components Five-Year Limited Warranty

See website for detailed warranty information.

Available Color/Finishes

Color tiles intended for reference only.

Color Code Description

| | | |
|--|----|---------|
|  | 0 | White |
|  | 96 | Biscuit |
|  | 47 | Almond |
|  | NY | Dune |
|  | G9 | Sandbar |

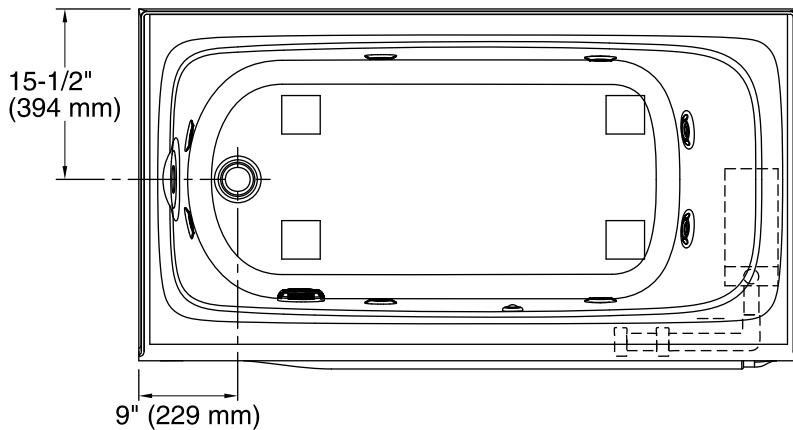

No change in measurements if connected with drain illustrated. (K-11677)

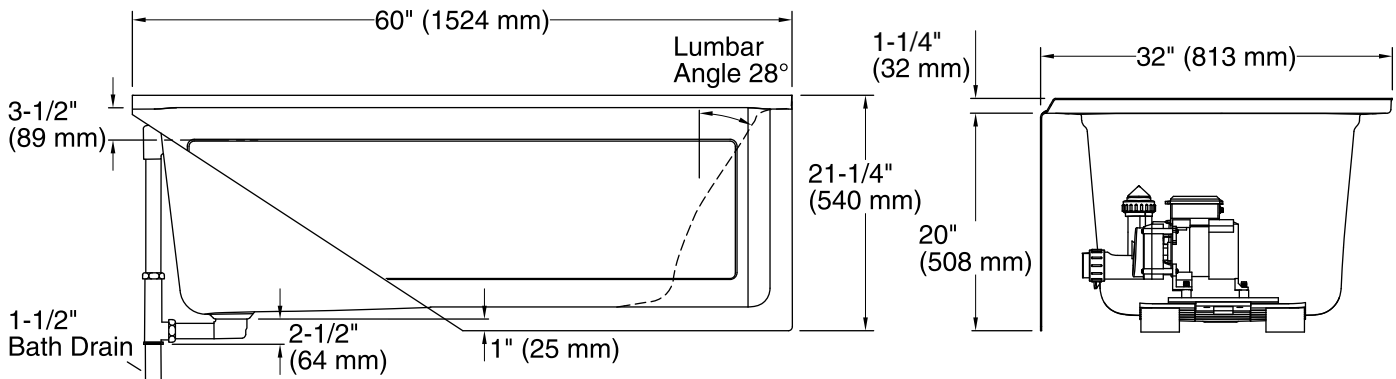
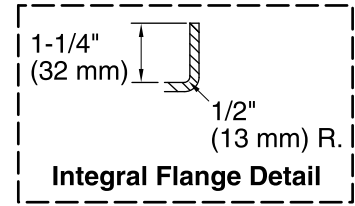

Required Electrical Service

Two dedicated circuits required, protected with Class A Ground-Fault Circuit-Interrupter (GFCI) or Residual Current Device (RCD).

Pump: 120 V, 15 A, 60 Hz
Heater: 120 V, 15 A, 60 Hz

Technical Information

All product dimensions are nominal.

Installation: 3-Wall Alcove
Drain location: Left
Basin area, bottom: 45" x 22" (1143 mm x 559 mm)
Basin area, top: 54" x 25" (1372 mm x 635 mm)
Weight: 140 lbs (63.5 kg)
Minimum floor load: 50 lbs/ft² (244.1 kg/m²)
Water depth: 15" (381 mm)
Water capacity: 60 gal (227.1 L)
Electrical component rating: Pump: 120 V, 7 A, 60 Hz
Heater: 120 V, 12.5 A, 60 Hz, 1500 W
Pump speed: Single
Minimum flat for door: 2" (51 mm)

Notes

Measure your actual product for rough-in details. Install this product according to the installation instructions.

The hot water supply should be 70% of the capacity of the bath or greater. Installations will vary.

Provide one grounded electrical outlet within 24" (610 mm) of each component.