



### Features

- 120 airjets release thousands of bubbles that surround, support, and massage the body.
- Variable-speed blower lets you adjust massage intensity to 18 levels.
- Molded lumbar support offers extra comfort while bathing.
- Integral apron.
- Integral flange helps prevent water from seeping behind wall and simplifies alcove installation.
- Textured bottom surface
- Left-hand drain.
- Coordinates with other products in the Bancroft collection.

### Material

- Acrylic

### Hydrotherapy

- BubbleMassage

### Installation

- Three-wall alcove.

### Recommended Accessories

- K-11677 Bath Drain
- K-1446 Remote Installation Kit
- K-9497 2-1/2" Keypad Trim
- K-24916 Wireless Music Kit
- K-1491 Bath/Whirlpool Pillow
- K-1601 Bath/Whirlpool Footstop
- K-7259 Clearflo Bath Drain
- K-702200-G54 Frameless Sliding Bath Door
- K-702200-G73 Frameless Sliding Bath Door
- K-702200-L Frameless Sliding Bath Door
- K-702205-L Frameless Sliding Bath Door
- K-706000-D3 Frameless Sliding Bath Door
- K-706000-L Frameless Sliding Bath Door
- K-706003-L Frameless Sliding Bath Door
- K-706004-D3 Frameless Sliding Bath Door
- K-706004-L Frameless Sliding Bath Door
- K-706007-L Frameless Sliding Bath Door



### Codes/Standards

ASME A112.19.7/CSA B45.10  
CSA B45.5/IAPMO Z124  
ASTM E162  
ASTM E662  
UL 1795  
Greenguard UL 2818 - Gold





**KOHLER® Plastic Baths and Receptors  
Lifetime Limited Warranty  
KOHLER® Hydrotherapy Components  
Five-Year Limited Warranty**

See website for detailed warranty information.

### Available Color/Finishes

*Color tiles intended for reference only.*

#### Color Code Description

	0	White
	96	Biscuit
	47	Almond
	NY	Dune
	G9	Sandbar

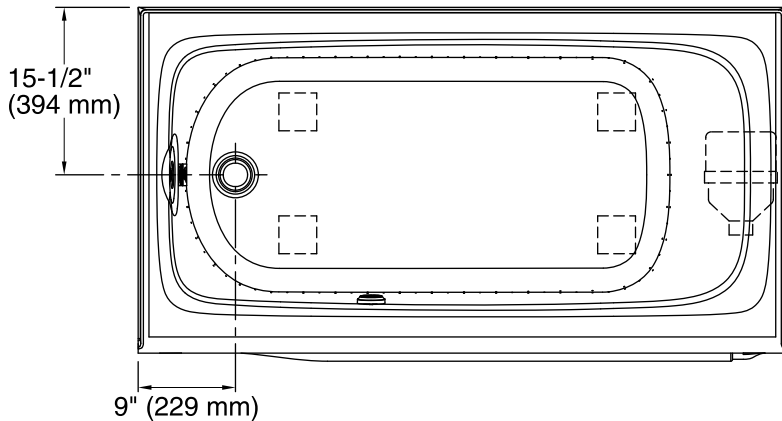

No change in measurements if connected with drain illustrated. (K-11677)

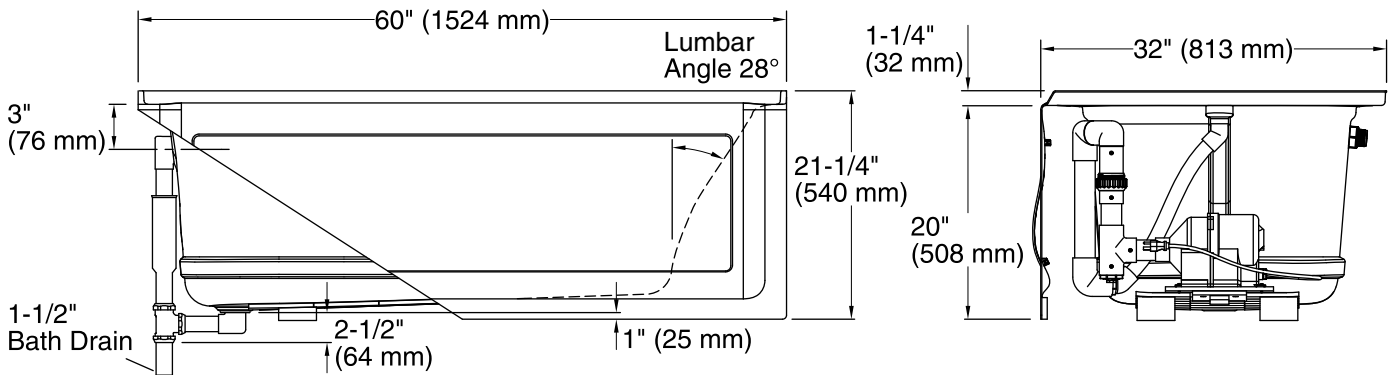
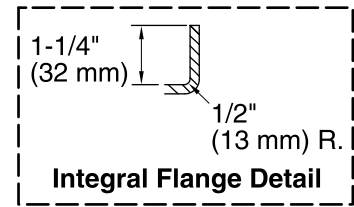

## Required Electrical Service

One dedicated circuit required, protected with Class A Ground-Fault Circuit-Interrupter (GFCI) or Residual Current Device (RCD).

Blower: 120 V, 15 A, 60 Hz

## Technical Information

All product dimensions are nominal.

Installation: 3-Wall Alcove  
 Drain location: Left  
 Basin area, bottom: 45" x 22" (1143 mm x 559 mm)  
 Basin area, top: 54" x 25" (1372 mm x 635 mm)  
 Weight: 100 lbs (45.4 kg)  
 Minimum floor load: 49 lbs/ft<sup>2</sup> (239.2 kg/m<sup>2</sup>)  
 Water depth: 15" (381 mm)  
 Water capacity: 60 gal (227.1 L)  
 Electrical component rating: Blower: 120 V, 10 A, 60 Hz  
 Minimum flat for door: 2" (51 mm)

## Notes

Measure your actual product for rough-in details. Install this product according to the installation instructions.

The hot water supply should be 70% of the capacity of the bath or greater. Installations will vary.

Provide one grounded electrical outlet within 24" (610 mm) of each component.

Remote blower installation kit is available for relocating the blower. Provide access for servicing the blower.

Do not relocate or alter the PVC tee or coiled flexible tubing connected to the blower. Follow the blower relocation instructions exactly.