



### Features

- Single-speed whirlpool offers performance and value, with 8 fully adjustable jets.
- Hydromassage flow and direction can be controlled at each jet.
- Comfort Depth® design offers a convenient 19-inch step-over height while retaining the same depth as a standard 21-inch bath.
- Generous 6-foot length provides an incredibly spacious bathing area.
- Molded lumbar support offers extra comfort while bathing.
- Slotted overflow allows for deep soaking.
- Textured bottom surface
- Reversible drain.
- Coordinates with other products in the Archer collection.

### Material

- Acrylic

### Hydrotherapy

- Whirlpool

### Installation

- Drop-in

### Required Accessories

K-7271 Brass Slotted Overflow Bath Drain

or

K-7272 PVC Slotted Overflow Bath Drain

### Recommended Accessories

K-9529 Removable Bath Seat

K-24916 Wireless Music Kit

K-1491 Bath/Whirlpool Pillow

K-1601 Bath/Whirlpool Footstop



### ADA

### Codes/Standards

ASME A112.19.7/CSA B45.10

CSA B45.5/IAPMO Z124

ASTM E162

ASTM E662

UL 1795

Greenguard UL 2818 - Gold

ADA

ICC/ANSI A117.1

### KOHLER® Plastic Baths and Receptors

### Lifetime Limited Warranty

### KOHLER® Hydrotherapy Components







### Five-Year Limited Warranty

See website for detailed warranty information.

### Available Color/Finishes

*Color tiles intended for reference only.*

#### Color Code Description

	0	White
	96	Biscuit
	47	Almond
	NY	Dune
	95	Ice™ Grey
	G9	Sandbar

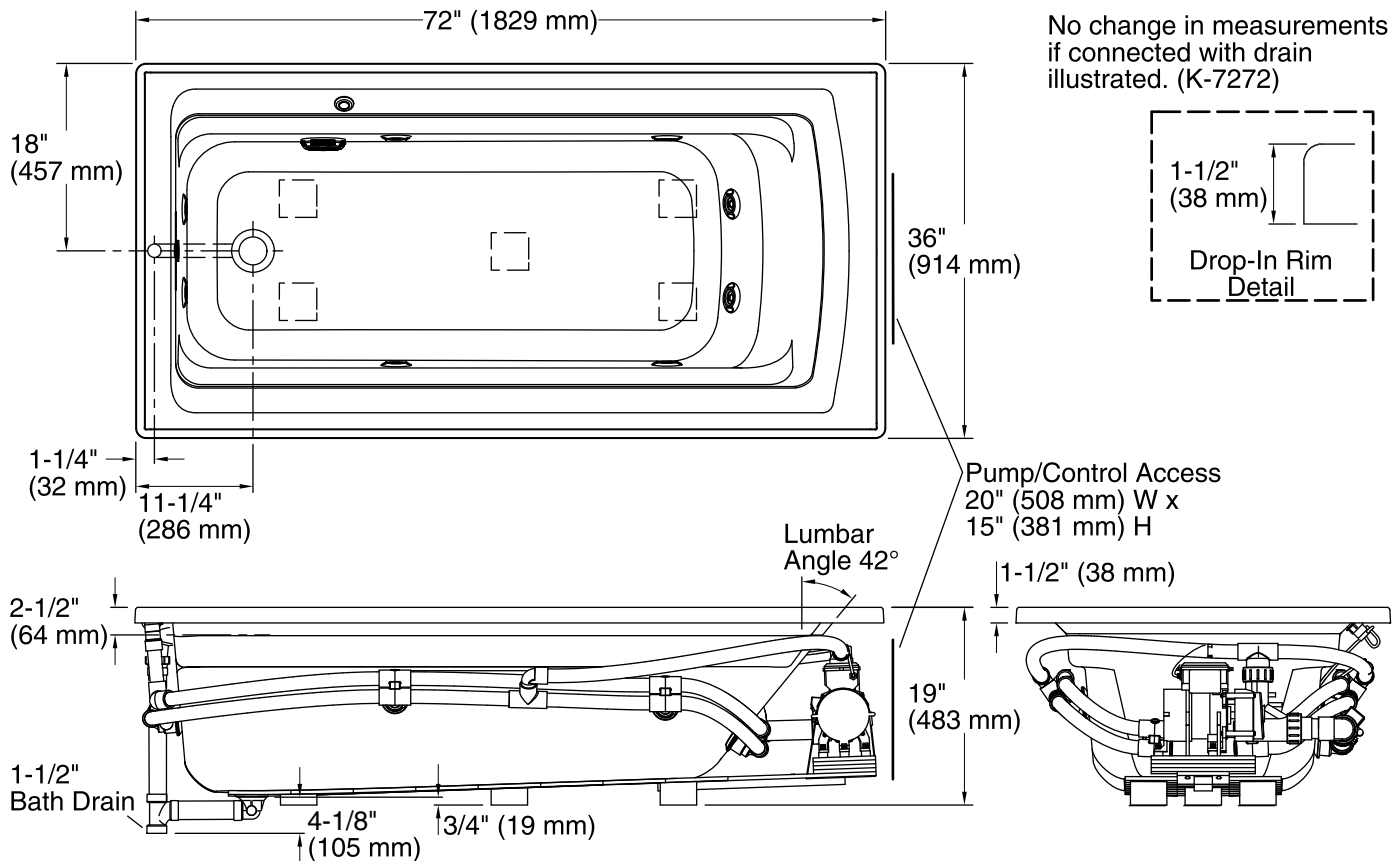

### Required Electrical Service

One dedicated circuit required, protected with Class A Ground-Fault Circuit-Interrupter (GFCI) or Residual Current Device (RCD).

Pump: 120 V, 15 A, 60 Hz

### Technical Information

All product dimensions are nominal.

Installation: Drop-in  
 Drain location: End  
 Basin area, bottom: 51-3/8" x 21" (1305 mm x 533 mm)  
 Basin area, top: 64-1/2" x 30-1/2" (1638 mm x 775 mm)  
 Weight: 110 lbs (49.9 kg)  
 Minimum floor load: 41 lbs/ft<sup>2</sup> (200.2 kg/m<sup>2</sup>)  
 Water depth: 15" (381 mm)  
 Water capacity: 72 gal (272.5 L)  
 Cutout: Drop-in, 70-1/2" x 34-1/2" (1791 mm x 876 mm)  
 Electrical component rating: Pump: 120 V, 7 A, 60 Hz  
 Minimum flat for door: 1-9/16" (40 mm)

### Notes

Measure your actual product for rough-in details. Install this product according to the installation instructions.

The hot water supply should be 70% of the capacity of the bath or greater. Installations will vary.

This product is designed for drop-in installation only. It is not suited for use in a three-wall alcove with an overhead shower.

ADA compliant when installed to the specific requirements of these regulations.