



### Features

- 120 airjets release thousands of bubbles that surround, support, and massage the body.
- Variable-speed blower lets you adjust massage intensity to 18 levels.
- Comfort Depth® design offers a convenient 19-inch step-over height while retaining the same depth as a standard 21-inch bath.
- Generous 6-foot length provides an incredibly spacious bathing area.
- Molded lumbar support offers extra comfort while bathing.
- Slotted overflow allows for deep soaking.
- Integral apron.
- Integral flange helps prevent water from seeping behind wall and simplifies alcove installation.
- Textured bottom surface
- Right-hand drain.

### Material

- Acrylic

### Hydrotherapy

- BubbleMassage

### Installation

- Three-wall alcove.

### Required Accessories

K-7271 Brass Slotted Overflow Bath Drain

or

K-7272 PVC Slotted Overflow Bath Drain

### Recommended Accessories

K-1446 Remote Installation Kit

K-9529 Removable Bath Seat

K-24916 Wireless Music Kit



### ADA

### Codes/Standards

CSA B45.5/IAPMO Z124

ASTM E162

ASTM E662

UL 1795

Greenguard UL 2818 - Gold

ADA

ICC/ANSI A117.1

### KOHLER® Plastic Baths and Receptors

### Lifetime Limited Warranty

### KOHLER® Hydrotherapy Components







### Five-Year Limited Warranty

See website for detailed warranty information.

### Available Color/Finishes

*Color tiles intended for reference only.*

#### Color Code Description

	0	White
	96	Biscuit
	47	Almond
	NY	Dune
	95	Ice™ Grey
	G9	Sandbar
	K4	Cashmere

No change in measurements if connected with drain illustrated. (K-7272)

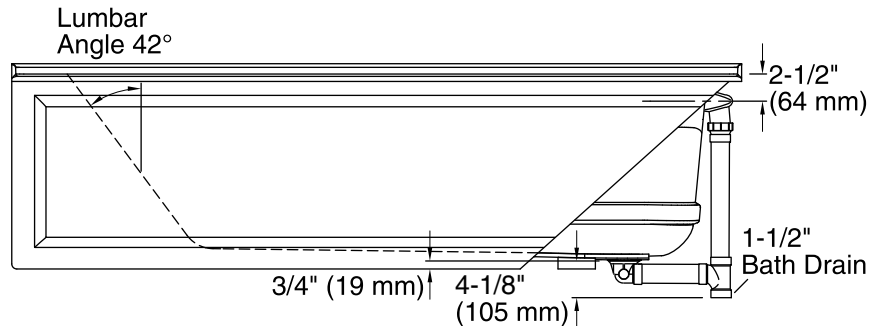
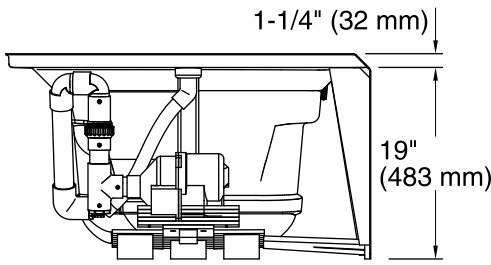
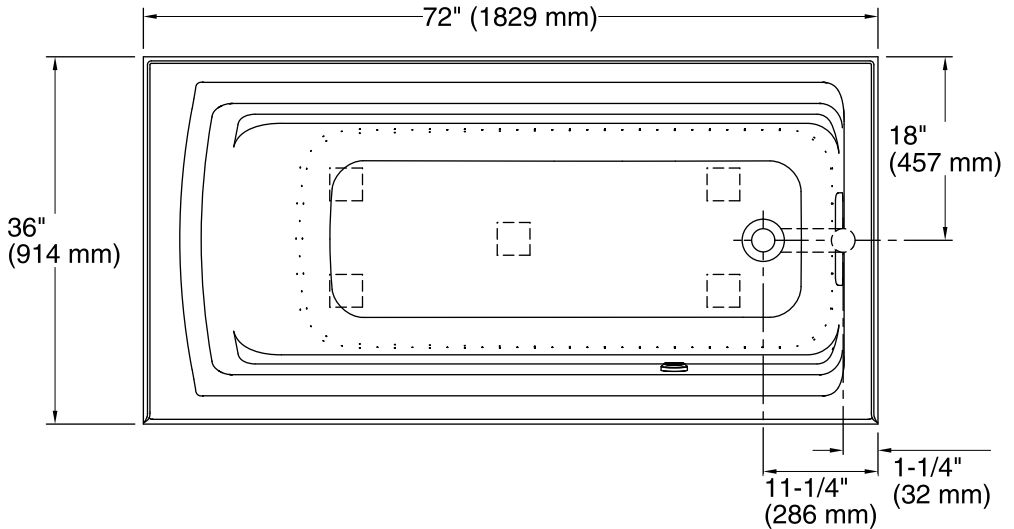
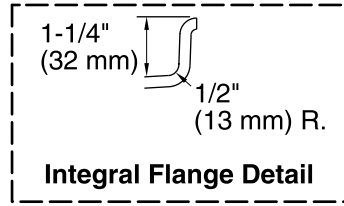

### Required Electrical Service

One dedicated circuit required, protected with Class A Ground-Fault Circuit-Interrupter (GFCI) or Residual Current Device (RCD).

Blower: 120 V, 15 A, 60 Hz

### Technical Information

All product dimensions are nominal.

Installation: 3-Wall Alcove  
 Drain location: Right  
 Basin area, bottom: 51-3/8" x 21" (1305 mm x 533 mm)  
 Basin area, top: 64-1/2" x 30-1/2" (1638 mm x 775 mm)  
 Weight: 115 lbs (52.2 kg)  
 Minimum floor load: 42 lbs/ft<sup>2</sup> (205.1 kg/m<sup>2</sup>)  
 Water depth: 15" (381 mm)  
 Water capacity: 72 gal (272.5 L)  
 Electrical component rating: Blower: 120 V, 10 A, 60 Hz  
 Minimum flat for door: 1-9/16" (40 mm)

### Notes

Measure your actual product for rough-in details. Install this product according to the installation instructions.  
 The hot water supply should be 70% of the capacity of the bath or greater. Installations will vary.  
 Remote blower installation kit K-1446 is available for relocating the blower. Provide access for servicing the blower.  
 Do not relocate or alter the PVC tee or coiled flexible tubing connected to the blower. Follow the blower relocation instructions exactly.  
 ADA compliant when installed to the specific requirements of these regulations.