



### Features

- Single-speed whirlpool offers performance and value, with 8 fully adjustable jets.
- Hydromassage flow and direction can be controlled at each jet.
- Built-in heater.
- Comfort Depth® design offers a convenient 19-inch step-over height while retaining the same depth as a standard 21-inch bath.
- Molded lumbar support offers extra comfort while bathing.
- Slotted overflow allows for deep soaking.
- Integral apron.
- Integral flange helps prevent water from seeping behind wall and simplifies alcove installation.
- Right-hand drain.
- Coordinates with other products in the Archer collection.



### Material

- Acrylic

### Hydrotherapy

- Whirlpool

### Installation

- Three-wall alcove.

### Required Accessories

K-7271 Brass Slotted Overflow Bath Drain

or

K-7272 PVC Slotted Overflow Bath Drain

### Recommended Accessories

K-24916 Wireless Music Kit

K-1491 Bath/Whirlpool Pillow

K-1601 Bath/Whirlpool Footstop

K-702200-G54 Frameless Sliding Bath Door

K-702200-G73 Frameless Sliding Bath Door

K-702200-L Frameless Sliding Bath Door

K-702205-L Frameless Sliding Bath Door

### ADA

### Codes/Standards

ASME A112.19.7/CSA B45.10

CSA B45.5/IAPMO Z124

UL 1795

Greenguard UL 2818 - Gold

ADA

ICC/ANSI A117.1

### KOHLER® Plastic Baths and Receptors

### Lifetime Limited Warranty









### KOHLER® Hydrotherapy Components

### Five-Year Limited Warranty

See website for detailed warranty information.

### Available Color/Finishes

*Color tiles intended for reference only.*

Color	Code	Description
	0	White
	96	Biscuit
	47	Almond
	NY	Dune
	95	Ice™ Grey
	G9	Sandbar
	K4	Cashmere
	58	Thunder™ Grey

No change in measurements if connected with drain illustrated. (K-7272)

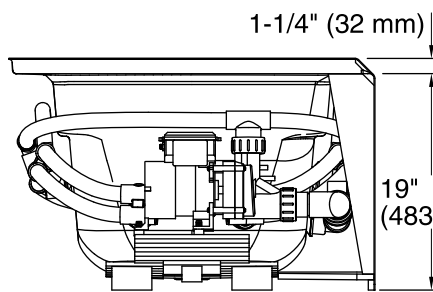
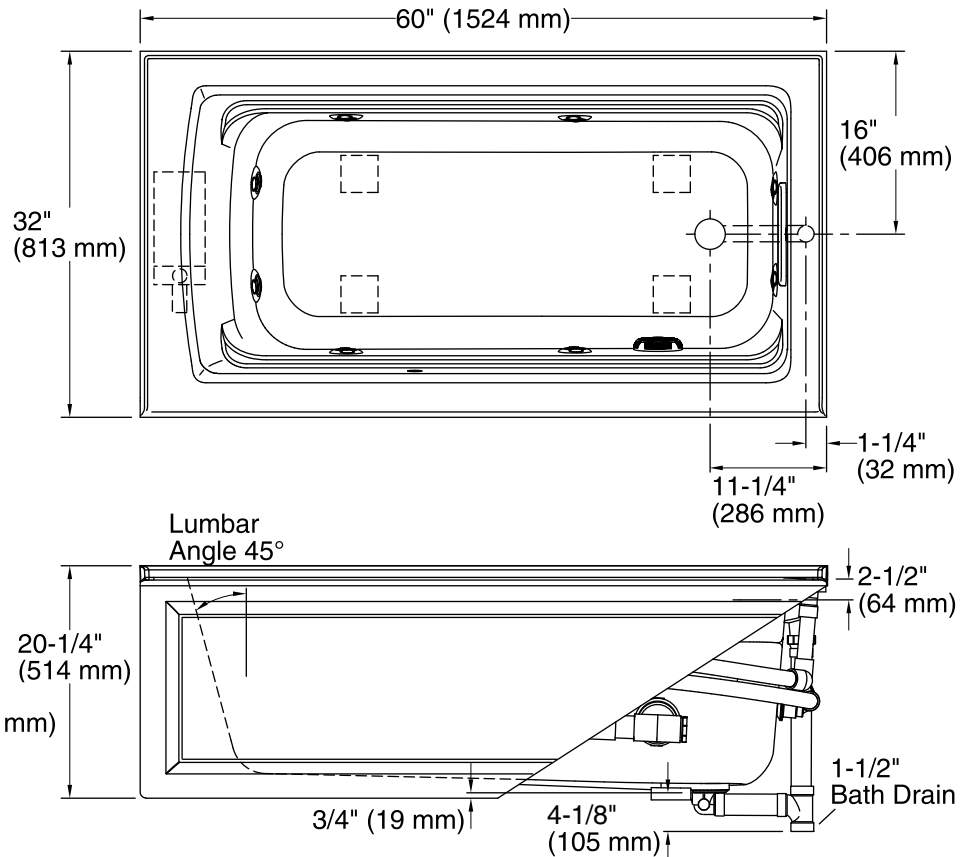
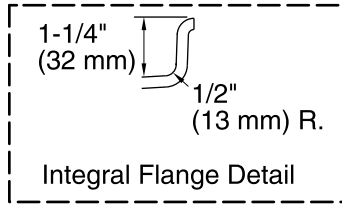

### Required Electrical Service

Two dedicated circuits required, protected with Class A Ground-Fault Circuit-Interrupter (GFCI) or Residual Current Device (RCD).

Pump: 120 V, 15 A, 60 Hz  
Heater: 120 V, 15 A, 60 Hz

### Technical Information

All product dimensions are nominal.

Installation: 3-Wall Alcove  
Drain location: Right  
Basin area, bottom: 45-1/8" x 19-11/16" (1146 mm x 500 mm)  
Basin area, top: 52-3/4" x 25-5/16" (1340 mm x 643 mm)  
Weight: 140 lbs (63.5 kg)  
Minimum floor load: 49 lbs/ft<sup>2</sup> (239.2 kg/m<sup>2</sup>)  
Water depth: 15" (381 mm)  
Water capacity: 58 gal (219.6 L)  
Electrical component rating: Pump: 120 V, 7 A, 60 Hz  
Heater: 120 V, 12.5 A, 60 Hz, 1500 W  
Pump speed: Single  
Minimum flat for door: 2-3/16" (56 mm)

### Notes

Measure your actual product for rough-in details. Install this product according to the installation instructions.  
The hot water supply should be 70% of the capacity of the bath or greater. Installations will vary.  
Provide one grounded electrical outlet within 24" (610 mm) of each component.  
ADA compliant when installed to the specific requirements of these regulations.