



### Features

- Integral flange.
- Right drain.
- Slotted overflow for deep soaking.
- Comfort Depth® design offers a 19" (483 mm) step-over height.
- Bask® heated surface creates spa-like relaxation with soothing warmth on your back, shoulders, and neck.
- Integral lumbar support and armrests for comfort.
- Integral apron with removable access panel.
- Coordinates with other products in the Archer® collection.
- 60" (1524 mm) x 32" (813 mm) x 20-1/4" (514 mm)

### Material

- Acrylic

### Hydrotherapy

- 120 BubbleMassage™ airjets.
- Automatic purge cycles remove residual water from air channels after use.
- Built-in 300 W heater.
- Electronic keypad control.

### Installation

- Alcove

### Required Accessories

K-7271 Brass Slotted Overflow Bath Drain

or

K-7272 PVC Slotted Overflow Bath Drain

### Recommended Accessories

K-24916 Wireless Music Kit



### ADA

### Codes/Standards

ASME A112.19.7/CSA B45.10

CSA B45.5/IAPMO Z124

ASTM E162

UL 1795

Greenguard UL 2818 - Gold

ADA

ICC/ANSI A117.1

### KOHLER® Plastic Baths and Receptors

### Lifetime Limited Warranty

### KOHLER® Hydrotherapy Components







### Five-Year Limited Warranty

See website for detailed warranty information.

### Available Color/Finishes

*Color tiles intended for reference only.*

#### Color Code Description

	0	White
	96	Biscuit
	47	Almond
	NY	Dune
	95	Ice™ Grey
	G9	Sandbar
	K4	Cashmere

No change in measurements if connected with drain illustrated. (K-7271 or K-7272)

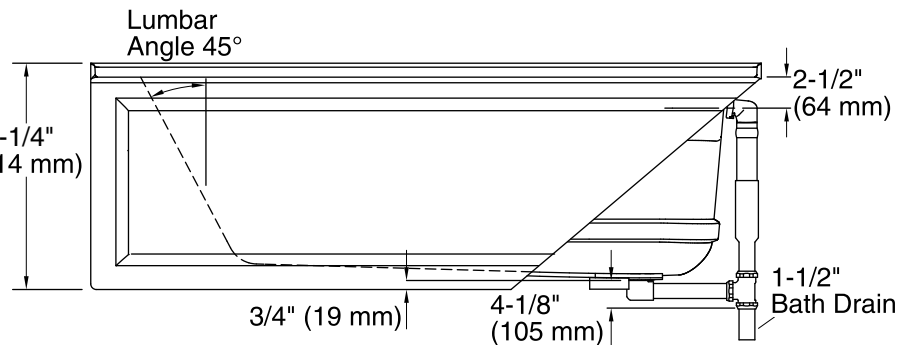
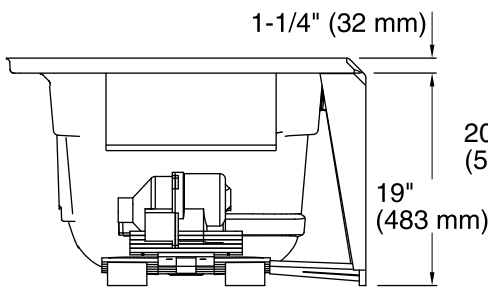
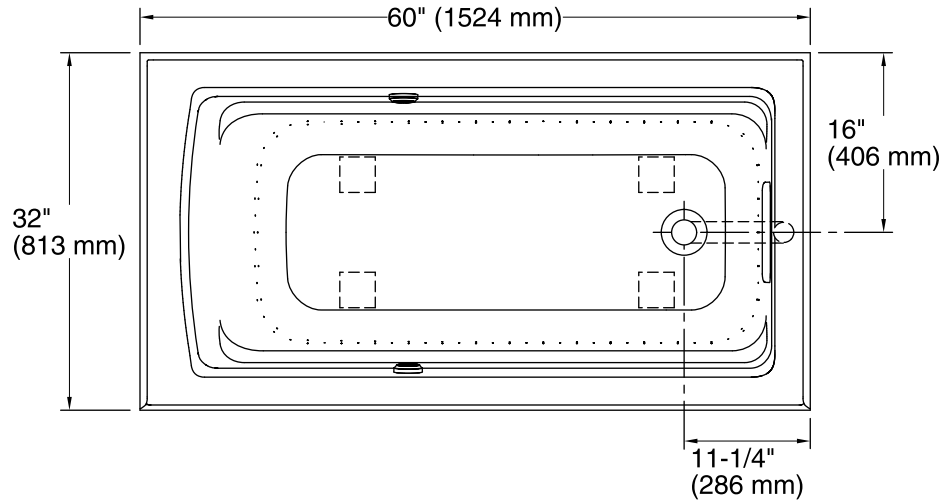
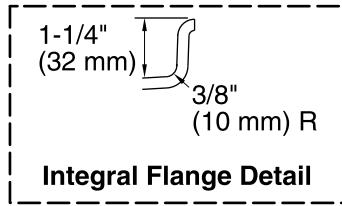

### Required Electrical Service

One dedicated circuit required, protected with Class A Ground-Fault Circuit-Interrupter (GFCI) or Residual Current Device (RCD).

Blower, Heated Surface: 120 V, 15 A, 60 Hz

### Technical Information

All product dimensions are nominal.

Installation: 3-Wall Alcove  
 Drain location: Right  
 Basin area, bottom: 45-1/8" x 19-11/16" (1146 mm x 500 mm)  
 Basin area, top: 52-3/4" x 25-5/16" (1340 mm x 643 mm)  
 Weight: 106 lbs (48.1 kg)  
 Minimum floor load: 46 lbs/ft<sup>2</sup> (224.6 kg/m<sup>2</sup>)  
 Water depth: 15" (381 mm)  
 Water capacity: 58 gal (219.6 L)  
 Electrical component rating: Blower: 120 V, 10 A, 60 Hz  
 Heated Surface: 120 V, 0.5 A, 60 Hz, 65 W  
 Minimum flat for door: 2-3/16" (56 mm)

### Notes

Measure your actual product for rough-in details. Install this product according to the installation instructions.

The hot water supply should be 70% of the capacity of the bath or greater. Installations will vary.

Remote blower installation kit is available for relocating the blower. Provide access for servicing the blower.

Do not relocate or alter the PVC tee or coiled flexible tubing connected to the blower. Follow the blower relocation instructions exactly.

ADA compliant when installed to the specific requirements of these regulations.