



### Features

- Corner layout minimizes footprint without compromising bathing area.
- Center drain.
- Integral lumbar support and armrests for comfort.
- 54" (1372 mm) x 54" (1372 mm) x 20" (508 mm)

### Material

- Acrylic

### Hydrotherapy

- Single-speed whirlpool offers six fully adjustable hydro-massage jets for water flow and direction.
- Pump with air switch for whirlpool.

### Installation

- Drop-in

### Recommended Accessories

- K-11677 Bath Drain
- K-1491 Bath/Whirlpool Pillow
- K-1601 Bath/Whirlpool Footstop
- K-7213 27" Cable Bath Drain
- K-7214 27" Cable Bath Drain
- K-24916 Wireless Music Kit
- K-7259 Clearflo Bath Drain



### Codes/Standards

- ASME A112.19.7/CSA B45.10
- CSA B45.5/IAPMO Z124
- UL 1795
- Greenguard UL 2818 - Gold



**KOHLER® Plastic Baths and Receptors  
Lifetime Limited Warranty  
KOHLER® Hydrotherapy Components  
Five-Year Limited Warranty**

See website for detailed warranty information.

### Available Color/Finishes

*Color tiles intended for reference only.*

#### Color Code Description

	0	White
	96	Biscuit
	47	Almond

No change in measurements if connected with drain illustrated. (K-11677)

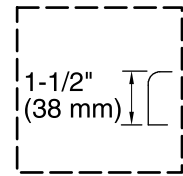
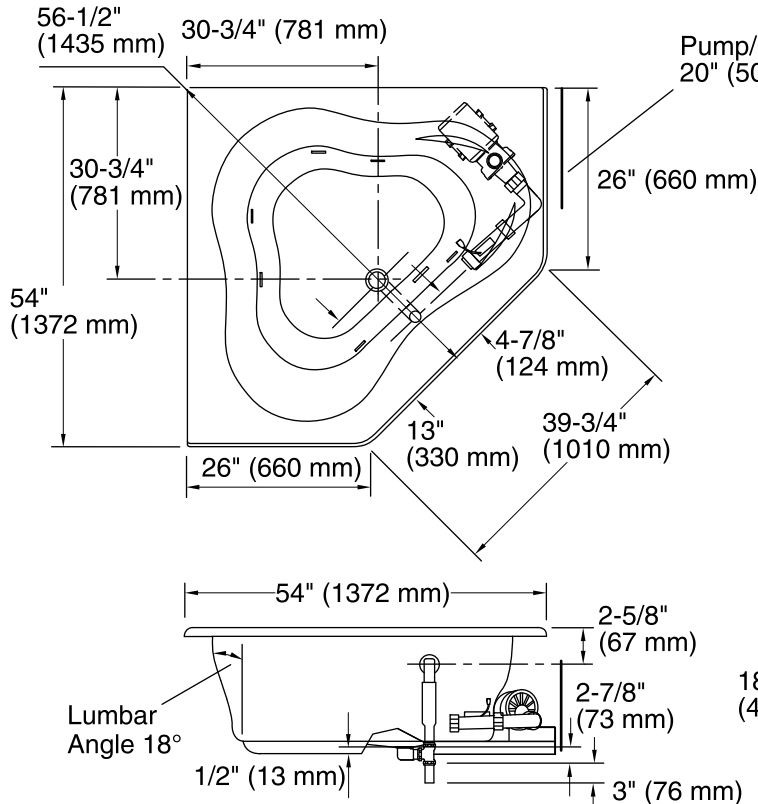

**Drop-in Rim Detail**

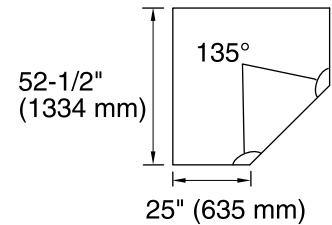

**Cut-out Detail  
Drop-in Rim Style**

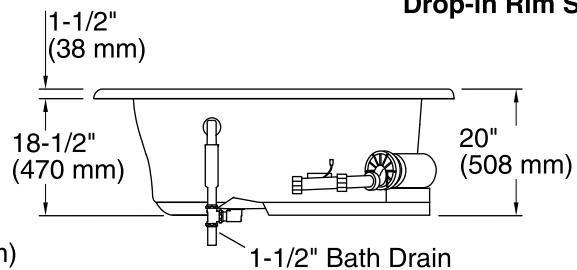

### Required Electrical Service

One dedicated circuit required, protected with Class A Ground-Fault Circuit-Interrupter (GFCI) or Residual Current Device (RCD).

Pump: 120 V, 15 A, 60 Hz

### Technical Information

All product dimensions are nominal.

Installation:	Drop-in, Corner
Drain location:	Center
Basin area, bottom:	44" x 36" (1118 mm x 914 mm)
Basin area, top:	56" x 43" (1422 mm x 1092 mm)
Weight:	65 lbs (29.5 kg)
Minimum floor load:	36 lbs/ft <sup>2</sup> (175.8 kg/m <sup>2</sup> )
Water depth:	15" (381 mm)
Water capacity:	76 gal (287.7 L)
Electrical component rating:	Pump: 120 V, 7.5 A, 60 Hz
Pump speed:	Single

### Notes

Measure your actual product for rough-in details. Install this product according to the installation instructions.

The hot water supply should be 70% of the capacity of the bath or greater. Installations will vary.