



Underscore® Rectangle

6' VibrAcoustic® BubbleMassage™ Bath

K-1174-GVBCW



Features

- Center drain.
- Slotted overflow for deep soaking.
- VibrAcoustic® technology emits sound waves and offers a surround sound experience.
- High-resolution color screen in polished chrome.
- Bask® heated surface creates spa-like relaxation with soothing warmth on your back, shoulders, and neck.
- Chromatherapy lighting allows you to select a preferred color scheme to suit your mood.
- Integral lumbar support.
- 72" (1829 mm) x 42" (1067 mm) x 23" (584 mm)

Material

- Acrylic

Hydrotherapy

- 122 BubbleMassage™ airjets.
- Variable-speed blower for adjusting hydromassage intensity.
- Automatic purge cycles remove residual water from air channels after use.
- Built-in 300 W heater.
- Six transducers and a control amplifier with 25' (7.6 m) of wiring.

Installation

- Drop-in or under-mount.
- Syncs with devices enabled with BLUETOOTH® wireless technology including smart phones, MP3 players, tablets and laptops located up to 33 feet away.*

Required Accessories

K-7271 Brass Slotted Overflow Bath Drain

or

K-7272 PVC Slotted Overflow Bath Drain

Recommended Accessories

1184460 Under-Mount Installation Kit

K-592 Under-Mount Installation Kit



Codes/Standards

ASME A112.19.7/CSA B45.10

CSA B45.5/IAPMO Z124

ASTM E162

ASTM E662

UL 1795

Greenguard UL 2818 - Gold

KOHLER® Plastic Baths and Receptors

Lifetime Limited Warranty

KOHLER® Hydrotherapy Components









Five-Year Limited Warranty

See website for detailed warranty information.

*The BLUETOOTH® word mark and logos are registered trademarks owned by Bluetooth SIG, Inc. and any use of such marks by Kohler Co. is under license. Other trademarks and trade names are those of their respective owners.

Available Color/Finishes

Color tiles intended for reference only.

Color	Code	Description
	0	White
	96	Biscuit
	47	Almond
	NY	Dune
	95	Ice™ Grey
	G9	Sandbar
	K4	Cashmere
	58	Thunder™ Grey

1-800-4KOHLER (1-800-456-4537)

Kohler Co. reserves the right to make revisions without notice to product specifications.

For the most current Specification Sheet, go to www.kohler.com.

10-5-2018 08:48

THE BOLD LOOK
OF **KOHLER**®

Underscore® Rectangle 6' VibrAcoustic® BubbleMassage™ Bath K-1174-GVBCW

No change in measurements if connected with required drain illustrated. (K-7272)

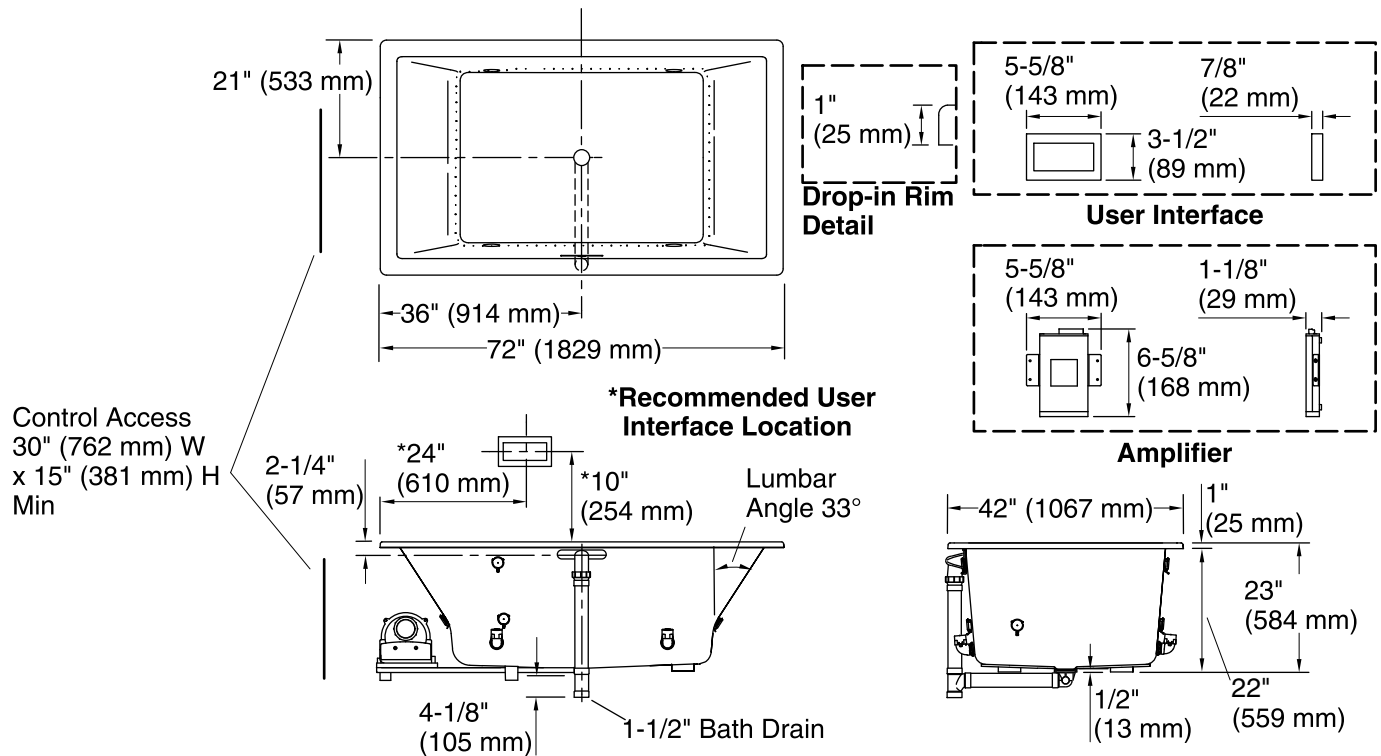

Required Electrical Service

One dedicated circuit required, protected with Class A Ground-Fault Circuit-Interrupter (GFCI) or Residual Current Device (RCD).

Blower, Heated Surface, Amplifier: 120 V, 15 A, 60 Hz

Technical Information

All product dimensions are nominal.

Installation:	Drop-in, Under-mount
Drain location:	Center
Basin area, bottom:	45-3/4" x 32" (1162 mm x 813 mm)
Basin area, top:	66" x 36" (1676 mm x 914 mm)
Weight:	120 lbs (54.4 kg)
Minimum floor load:	60.7 lbs/ft ² (296.4 kg/m ²)
Water depth:	19" (483 mm)
Water capacity:	139 gal (526.2 L)
Cutout:	Drop-in, 70-1/2" x 40-1/2" (1791 mm x 1029 mm)
Electrical component rating:	Blower: 120 V, 1.2 A, 60 Hz Heated Surface: 120 V, 0.5 A, 60 Hz, 65

Notes

Measure your actual product for rough-in details. Install this product according to the installation instructions.

The hot water supply should be 70% of the capacity of the bath or greater. Installations will vary.

Provide one grounded electrical outlet within 24" (610 mm) of each component.

Control amplifier fits 16" (406 mm) center studs. 25' (7.6 m) cables are included.

One electrical service may be used for the entire bath and related electrical components.

Remote blower installation kit K-1446 is available for relocating the blower. Provide access for servicing the blower.

Kit is required for under-mount installations (sold separately).

Do not relocate or alter the PVC tee or coiled flexible tubing connected to the blower. Follow the blower relocation instructions exactly.