

Features

- End drain.
- Chromatherapy lighting allows you to select a preferred color scheme to suit your mood.
- Integral lumbar support.
- Includes jet trim: Vibrant Brushed Nickel.
- 71-3/4" (1822 mm) x 36" (914 mm) x 20-7/8" (530 mm)

Material

- Cast iron with Safeguard® finish.

Hydrotherapy

- 40 BubbleMassage™ airjets. 18 levels of massage intensity.
- Zones of Control feature allows you to target massage to back, midsection, or feet.
- Automatic purge cycles remove residual water from air channels after use.
- Built-in 300 W heater.
- Lighted keypad control.

Installation

- Drop-in or under-mount.

Required Accessories

K-7169-AF 1-1/2" Contoured Pop-up Drain

Recommended Accessories

K-1491 Bath/Whirlpool Pillow
K-1601 Bath/Whirlpool Footstop
K-1705 Whirlpool/BubbleMassage™ Remote Control
K-582 Under-Mount Installation Kit
K-9498 3" Keypad Trim
K-1179 Vinyl Tiling-in Bead



Codes/Standards

ASME A112.19.1/CSA B45.2
ASME A112.19.7/CSA B45.10
ASTM F462
UL 1795
CSA C22.2 No. 218.2







KOHLER® Enameled Cast Iron Bath and Shower Base Lifetime Limited Warranty

KOHLER® Hydrotherapy Components Five-Year Limited Warranty

See website for detailed warranty information.

Available Color/Finishes

Color tiles intended for reference only.

Color	Code	Description
	0	White
	96	Biscuit
	47	Almond
	NY	Dune
	G9	Sandbar
	K4	Cashmere
	7	Black Black™

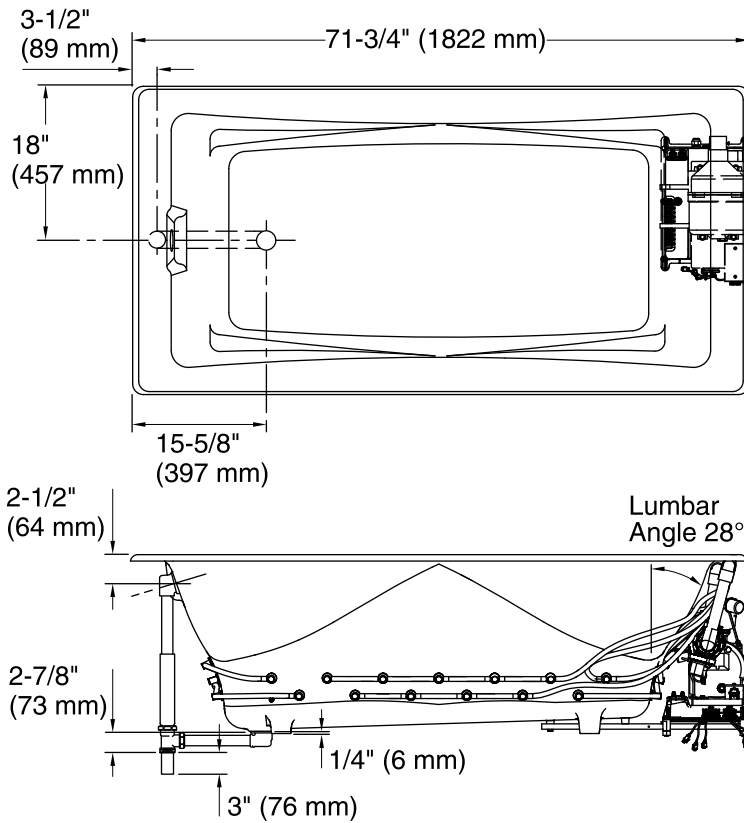

No change in measurements if connected with drain illustrated. (K-7169-AF)

Blower Motor/Control Access
 34" (864 mm) W x
 15" (381 mm) H

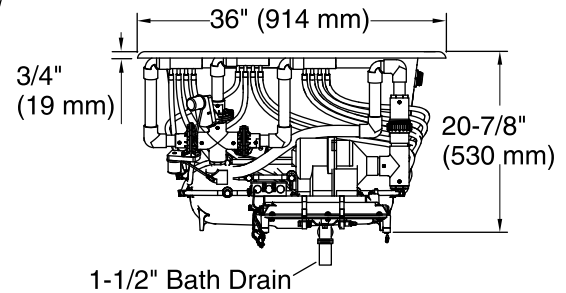

Required Electrical Service

One dedicated circuit required, protected with Class A Ground-Fault Circuit-Interrupter (GFCI) or Residual Current Device (RCD).

Blower: 240 V, 15 A, 50/60 Hz

Technical Information

All product dimensions are nominal.

Installation:	Drop-in, Under-mount
Drain location:	End
Basin area, bottom:	49" x 22" (1245 mm x 559 mm)
Basin area, top:	62" x 28" (1575 mm x 711 mm)
Weight:	455 lbs (206.4 kg)
Minimum floor load:	69 lbs/ft ² (336.9 kg/m ²)
Water depth:	17" (432 mm)
Water capacity:	89 gal (336.9 L)
Cutout:	Drop-in, 70-1/4" x 34-1/2" (1784 mm x 876 mm)
Template:	Under-mount, K-582, required, not included
Electrical component rating:	Blower: 240 V, 5 A, 50/60 Hz

Notes

Measure your actual product for rough-in details. Install this product according to the installation instructions.

The hot water supply should be 70% of the capacity of the bath or greater. Installations will vary.

Kit is required for under-mount installations (sold separately).

If relocating the blower motor, do not relocate or alter the PVC tee or coiled flexible tubing connected to the blower. Follow the blower relocation instructions exactly. Provide access for servicing the blower.