

# Essex

DVP9020  
DVP9021

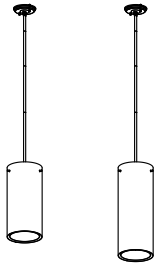

### Warning

All electrical connections must be made according to local codes. If you feel you do not have the experience necessary to do this, please have your fixture installed by a qualified, licensed electrician.

Make sure to note the maximum recommended wattage for your light fixture - DO NOT EXCEED THE RECOMMENDED WATTAGE

### Cleaning

We recommend that you use a mild detergent, such as dish washing soap, and warm water to clean the glass and metal surfaces. After cleaning, make sure to dry the fixture completely because moisture will corrode the satin finish. Use a damp soft cloth to wipe off dust. DO NOT USE abrasive pads or cleaning materials.

\*\*If you only have two wires coming from the electrical box, connect the fixture's copper wire to the Green ground screw on the crossbar.

### Tools

Phillips head screwdriver

DVP9020 1x100W A19

DVP9021 1x100W A19



**DVI**  
LIGHTING INC

120 Great Gulf Drive  
Concord, ON  
Canada, L4K 5W1  
Tel: 905.660.5600  
Fax: 905.660.5714

1

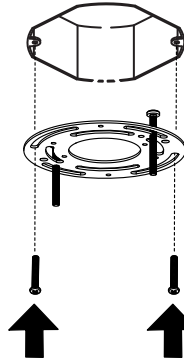

2

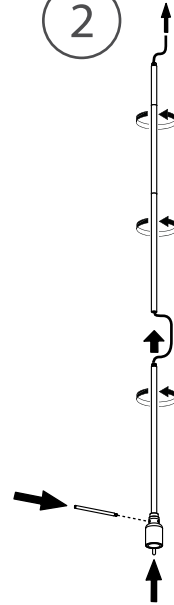

3

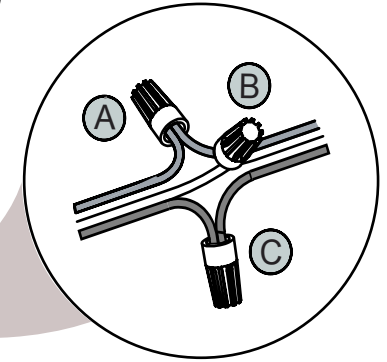
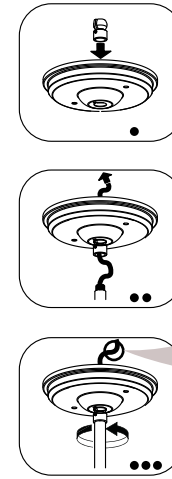

A. Copper ground wire to Ground Wire\*\*  
B. White Fixture Wire to White Supply Wire.  
C. Black Fixture Wire to Black Supply Wire.

4

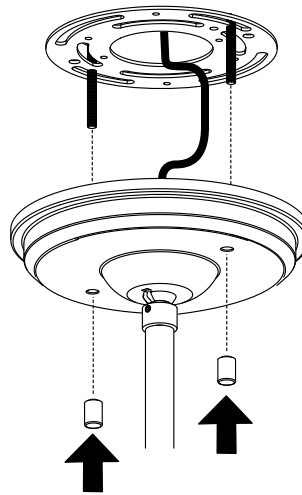

5

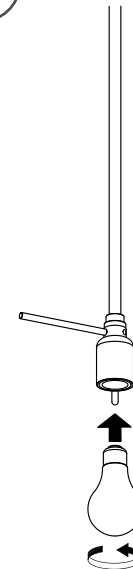

6

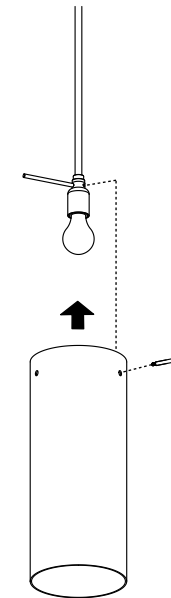

7

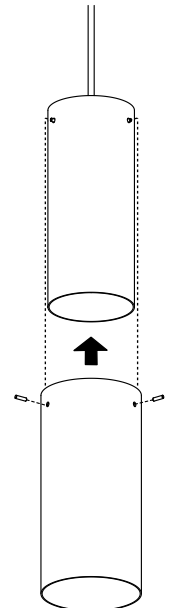

# Essex

DVP9020  
DVP9021

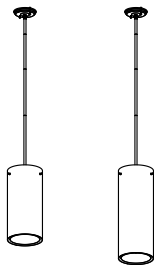

### Avertissement:

Risque d'incendie et de choc électrique. Ce produit doit être installé par un electricien qualifié seulement. Le fil doit être en conformité avec les codes électriques locaux et nationales.

Prenez bien note du wattage recommandé pour la lampe. Ne dépassez pas le wattage recommandé.

### Nettoyage:

Nous recommandons d'utiliser un détergent doux, comme du savon à vaisselle, et de l'eau tiède pour le verre et les surfaces métalliques. Assurez-vous de bien essuyer la lampe après coup pour empêcher l'humidité de ternir le fini satiné. Pour épousseter la lampe, utilisez un linge doux humide. Évitez les tampons abrasifs ou les produits de nettoyage.

S'il n'y a que deux fils qui sortent de la boîte de sortie électrique, fixez le fil en cuivre de l'appareil d'éclairage à la vis de terre en vert de la plaquette trouée.

Outils  
Tournevis Philips

DVP9020 1x100W A19

DVP9021 1x100W A19



**DVI**  
LIGHTING INC

120 Great Gulf Drive  
Concord, ON  
Canada, L4K 5W1  
Tel: 905.660.5600  
Fax: 905.660.5714

1

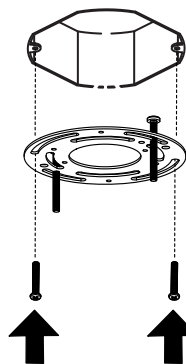

2

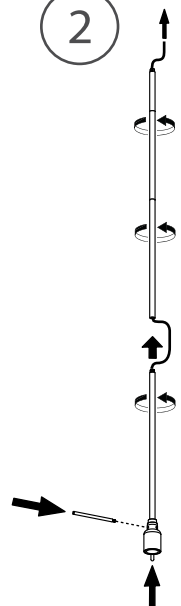

3

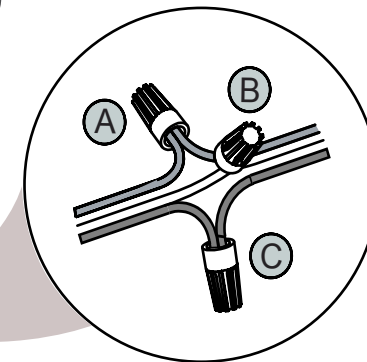
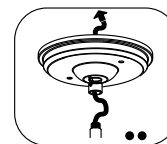

A. Fixez le fil de terre en cuivre à la mise à la terre.  
B. Reliez le fil blanc de l'appareil d'éclairage au fil blanc (neutre) de la boîte de sortie électrique.  
C. Reliez le fil noir de l'appareil d'éclairage au fil noir (alimentation) de la boîte de sortie électrique.

4

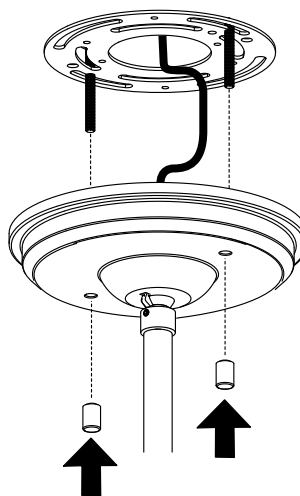

5

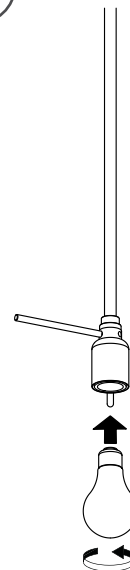

6

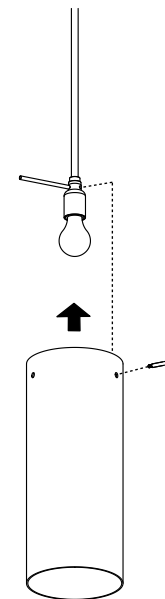

7

