

W 83119C18-CL

D18" H18" L4



We are dedicated to providing the finest quality crystal chandelier for our customers. Our master craftsmen and designer pride themselves on their attention to detail. prompt, efficient service is our priority.

Enclosed, are detailed instructions on how to properly install your chandelier. Please read all instructions carefully and thoroughly. If you have any questions please feel free to call our toll free DHANDELIER HOTLINE AT:

1-855-411-8999



# Crystal Dressing Instructions

When dressing the chandelier with the crystals please remember to wear either rubber or cotton gloves. So as to prevent any damage or smudging on the crystals.

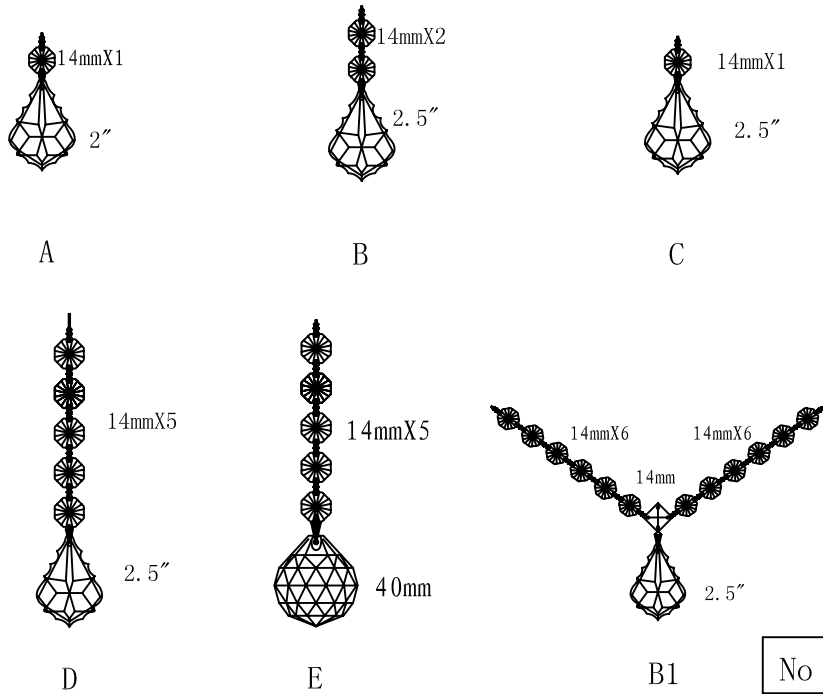

No	Quantity
A	24strings
B	4strings
B1	4strings
C	4strings
D	4strings
E	1string

# CANOPY PARTS LIST

Existing Electrical Box

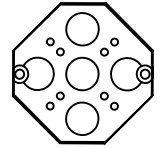

Crossbar Screws

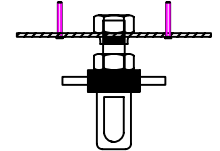

Crossbar Screws x 2 (not supplied)



Canopy

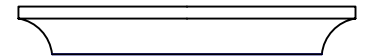

Glass Saucer

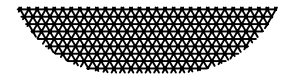

Chains



Wire Connector



Shrinkable tube

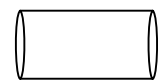

Cable tie



Ground Wire



# CANOPY INSTALLATION DIAGRAM

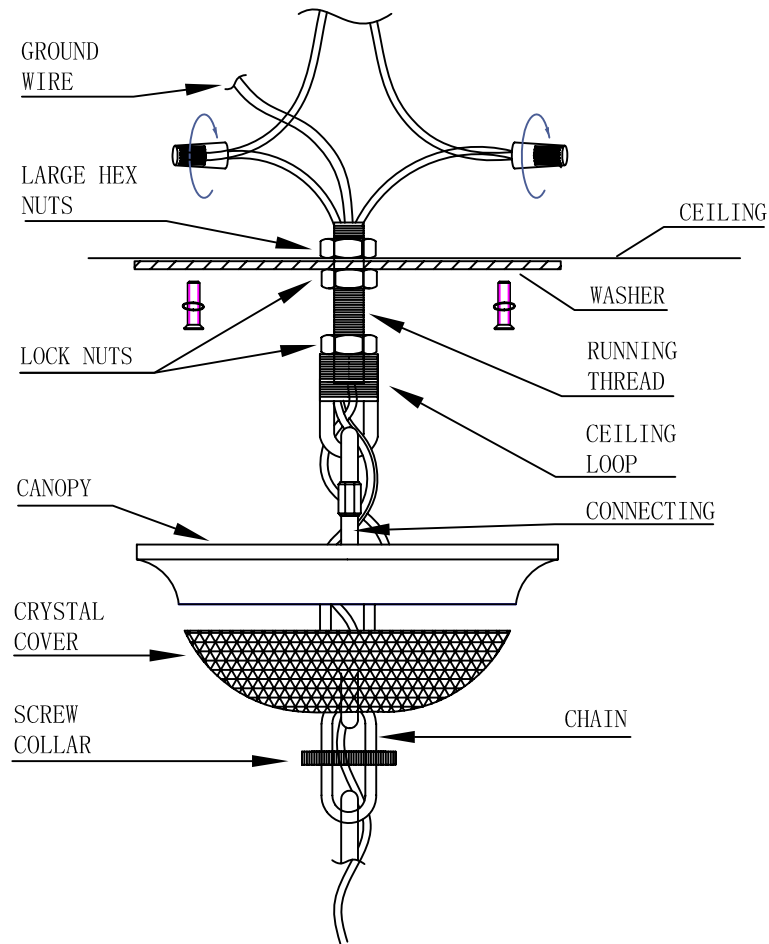

# Frame Assembly Instructions

8. Install scrolls into washer with screws provided. Install arms into large arm washer. Line up holes in arms with dimple in washer. Use lock washer and nut to secure arms in place. Connect bare ground wires in each arm to bare ground wire in center column. Use electrical tape to secure wire nuts, NO MORE THAN 5 - WIRESPER WIRE NUT . Sufficient quantities of jumper wires and wire nuts are provided.
9. Connect white arm wires to neutral column wire (ribbed or marked is neutral). Connect black arm wires to power wire in column. Carefully press wires as close as possible to the underside of washer.
10. Attach light assembly with lock washer and coupling with pipe. Install 5 - C7 bulbs. Attach glass assembly with rosette and round nut.
11. Install bobeches and bulbs, connect power and test the fixture BEFORE trimming. If any of the bulbs do NOT light - DISCONNECT POWER. Double check the wire connections.

The end!

## WARNING!!!

CONTENTS ARE FRAGILE  
HANDLE WITH CARE

The metal frame and crystal components of this chandelier are very delicate. Please exercise extreme Caution during unpacking and installation.

## WARNING!!!

After passing the main electrical wire through the 10mm pipe and connecting the pipe to the main body top connector, place all remaining pieces as shown in numerical order and in the orientation depicted. Refer to the parts list to avoid confusion between parts. The part Numbers coincide

## CAUTION

1. Rated 110v-130v/60Hz, bulb E12/40W maximum.
2. Care Should be taken to avoid damage to the surface of lighting and wire, wearing gloves is recommended when installing
3. Connect black or red wire of the lighting to live wire and white or blue wire to neutral wire and double colored (or bare copper) wire to ground wire.
4. Never install lighting on damp ceiling, the room should be dry and well ventilated.
5. Keep lighting away from acid, alkali and other corrosive chemical or gas, clean the lighting with Clean soft cloth only.
6. Installation must be carried out by qualified electrician only.
7. Disconnect the power before installing, cleaning and replacing lighting.
8. Never cover the lighting when power is connected.
9. Firmness must be secured when installing ceiling tube, chain, pipe and other connecting parts.
10. Care should be taken to avoid damage when installing glass parts.
11. All electrical components must be installed by a licensed electrician and in accordance with the National Electrical Code and the appropriate local electrical codes. Make sure that the electrical supply to the chandelier is turned off at the main fuse or circuit breaker before doing any installation Worldwide lighting shall not be responsible for unprofessional wiring.

01

## Crystal Dressing Diagram



When dressing the chandelier with the crystals please remember to wear either rubber or cotton gloves. So as to prevent any damage or smudging on the crystals.

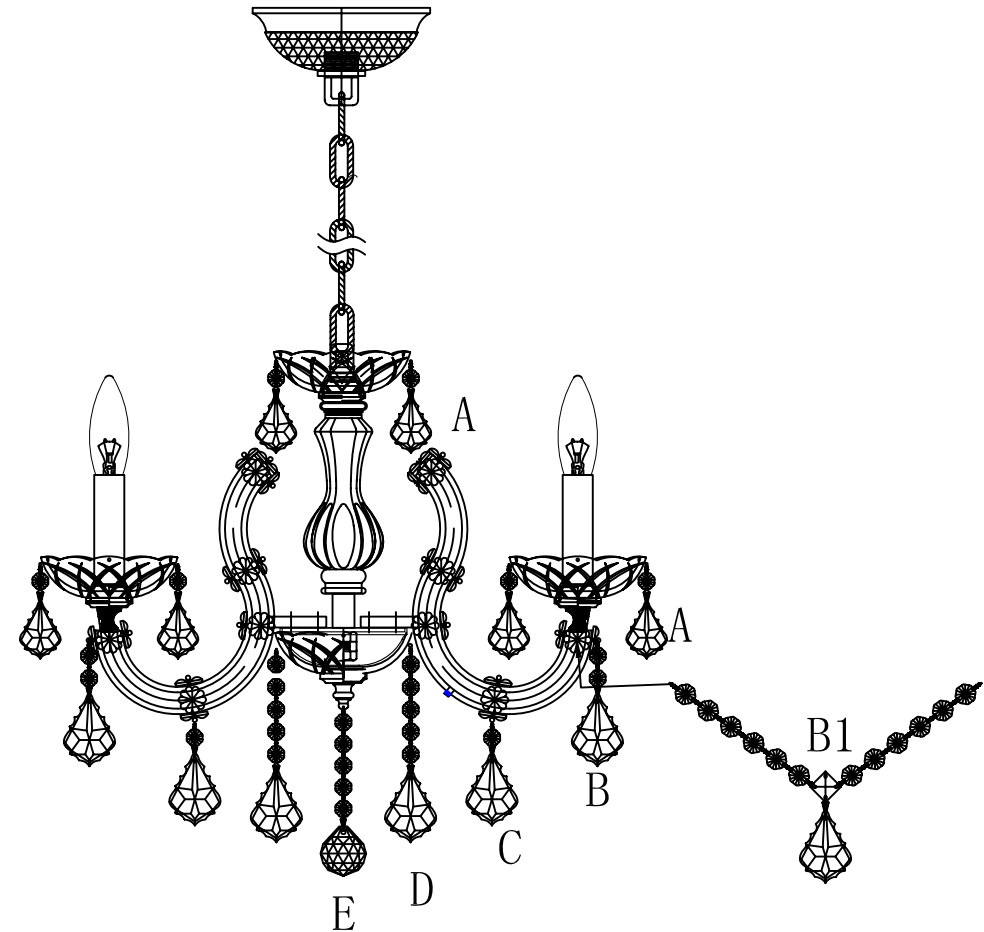

10

## Frame Assembly Diagram

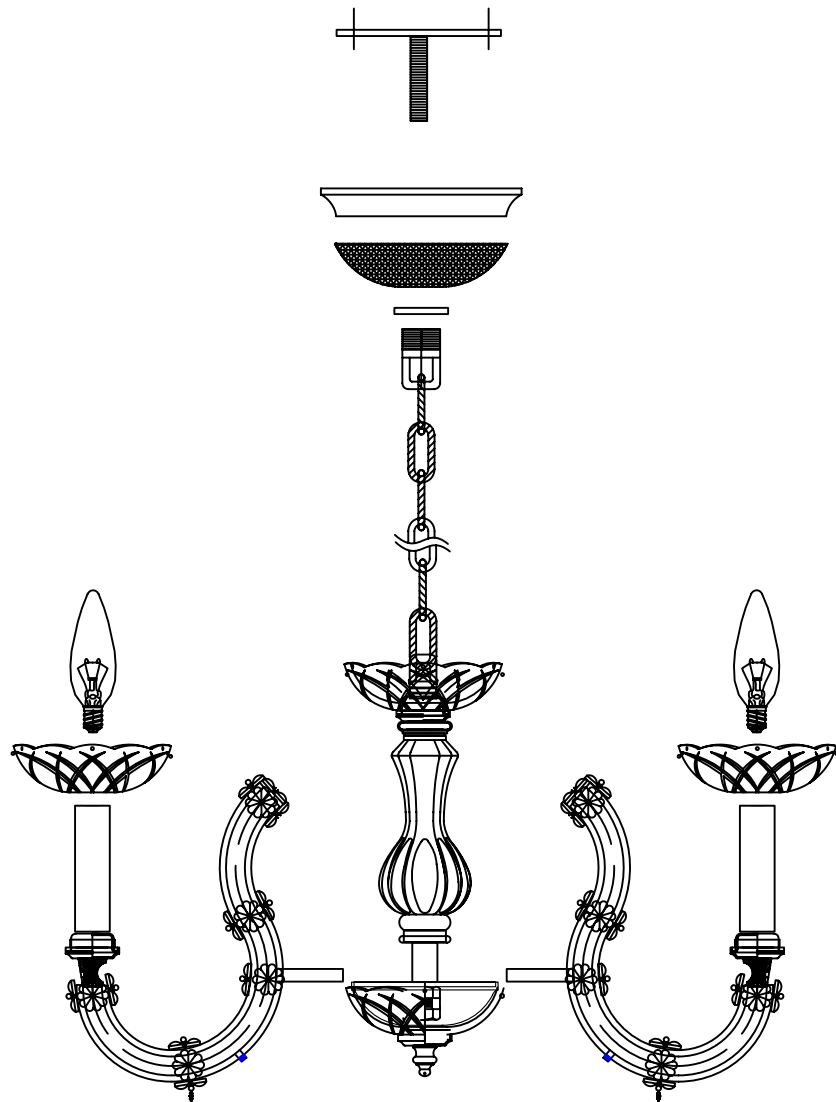

03

## CANOPY INSTALLATION INSTRUCTIONS

2. MAKE SURE POWER IS DISCONNECTED!!
3. Attach washer to supporting member in ceiling sufficient to support weight of fixture.
4. Slip screw collar, prismatic cover and metal canopy over chain. Determine the suspension length of the fixture and cut chain, if necessary. Use two connecting links to attach chain to chandelier loop and ceiling loop.
5. Insert stem wire through chain and ceiling loop. Connect wires. Fixture MUST be grounded.
6. Check distance from ceiling to loop to assure canopy assembly will be flush against ceiling.
7. Attach canopy to ceiling with screw collar.

08

**WARNING!!!**  
**CONTENTS ARE FRAGILE**  
**HANDLE WITH CARE**

The metal frame and crystal components of this chandelier are very delicate. Please exercise extreme Caution during unpacking and installation.

**WARNING!!!**

After passing the main electrical wire through the 10mm pipe and connecting the pipe to the main body top connector, place all remaining pieces as shown in numerical order and in the orientation depicted. Refer to the parts list to avoid confusion between parts. The part Numbers coincide

**CAUTION**

1. Rated 110v-130v/60Hz, bulb E12/40W maximum.
2. Care Should be taken to avoid damage to the surface of lighting and wire, wearing gloves is recommended when installing
3. Connect black or red wire of the lighting to live wire and white or blue wire to neutral wire and double colored (or bare copper) wire to ground wire.
4. Never install lighting on damp ceiling, the room should be dry and well ventilated.
5. Keep lighting away from acid, alkali and other corrosive chemical or gas, clean the lighting with Clean soft cloth only.
6. Installation must be carried out by qualified electrician only.
7. Disconnect the power before installing, cleaning and replacing lighting.
8. Never cover the lighting when power is connected.
9. Firmness must be secured when installing ceiling tube, chain, pipe and other connecting parts.
10. Care should be taken to avoid damage when installing glass parts.
11. All electrical components must be installed by a licensed electrician and in accordance with the National Electrical Code and the appropriate local electrical codes. Make sure that the electrical supply to the chandelier is turned off at the main fuse or circuit breaker before doing any installation. World wide lighting shall not be responsible for unprofessional wiring.

Installation:

Please read all instructions carefully.  
Before you proceed to install, make sure that the power supply is turned off and remains off until installation is complete.  
Please note that each part has been assigned a number.  
Please proceed in a numerical order.