

Please go to www. quozel. com for product cleaning tips. Go to the **Care + Maintenance** selection.

Tools Required: Flathead screwdriver, Phillips screwdriver, pliers, wire cutters, wire strippers, electrical tape, safety glasses.

Light Source: (6) G9 Base Clear Xenon Bulbs 40W Maximum.

Estimated Assembly Time: 30-45 minutes

Preparation: Identify and inspect all parts before beginning installation. Check package content list and diagrams below to be sure all parts are present. If any parts are missing or damaged, do not attempt to assemble, install, or operate the fixture. Contact customer service for replacement parts.

⚠ Warnings and Cautions

Turn off electricity at circuit breaker or main fuse box before installation. Consult a licensed electrician if in doubt.

These instructions are provided for your safety. It is very important you read them completely before installing the fixture. We strongly recommend that a licensed, professional electrician perform the installation.

Disconnect fixture from power source before replacing bulbs. Make sure bulbs are given sufficient time to cool before removal.

Package Contents

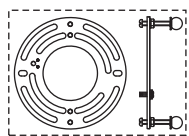

A Crossbar Assembly
x 1

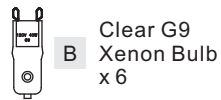

B Clear G9
Xenon Bulb
x 6

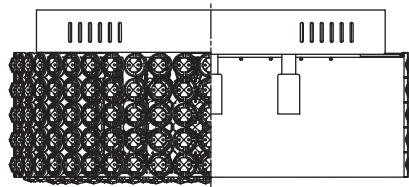

C Fixture Body
x 1



D Crystal String
x 60

STEP 1 - Install Crossbar Assembly

- A. Pass the supply wires through the Crossbar Assembly (A). Attach the Crossbar Assembly (A) to the Outlet Box with the head of the Green Ground Screw facing you. Secure it with Outlet Box Screws (not included). Tighten until snug.

Figure 1

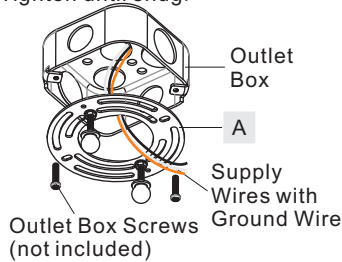

STEP 2 - Test Fitting Ceiling Canopy to Crossbar Assembly

- A. Remove mounting balls from the Crossbar Assembly (A). Fit ceiling canopy of Fixture Body (C) to the Crossbar Assembly (A) and secure

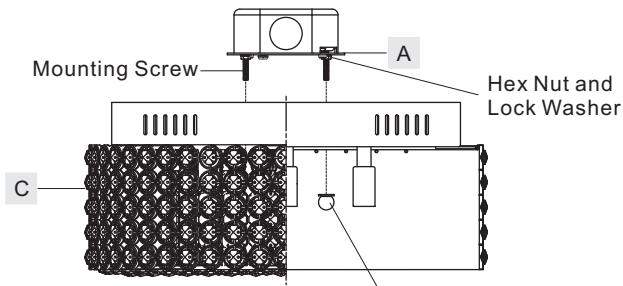

Figure 2

(Step 2 Continued)

with mounting balls. Note: The ceiling canopy of Fixture Body (C) should be snug against the ceiling and the mounting balls. If not, adjust the length of the nipple on the Crossbar Assembly (A) by unscrewing the preassembled hex nut and lock washer and then screwing the mounting screws in or out of the crossbar until the correct length is achieved. Once the ceiling canopy of Fixture Body (C) is secure, remove the mounting ball and Fixture Body (C) and proceed to Step 3.

STEP 3 - Wire Connections

- A. Use standard wire connectors (not included) to make all wire connections. Twist connectors until wires are tightly joined together. Wrap each connection with approved electrical tape and carefully stuff all the connected wires into the Outlet Box.

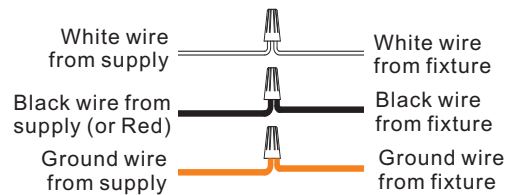

Figure 3

STEP 4 - Install Fixture Body

- A. Carefully tuck all wires into the outlet box and position the Fixture Body (C) over the outlet box. Align the holes in the ceiling canopy with the mounting screws, then attach the ceiling canopy using the previously removed mounting balls. Hand tighten until snug.

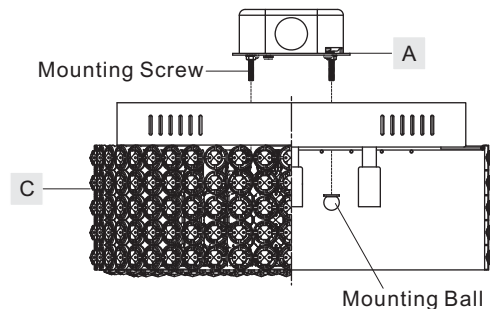

Figure 4

Thank you for purchasing a Quoizel product.
Need assistance with parts or assembly? Call Quoizel customer service at 1-800-645-3184
or visit us on-line at www. quozel. com

STEP 5 - Install Bulbs and Attach Crystal Strings

- A. Attach Crystal Strings (D) onto hangers on the bottom of ceiling canopy.
- B. Insert bulbs (B) into sockets and push snugly into place.
IMPORTANT: Do not touch the bulb with bare hands use a cloth or glove.

Your fixture is now assembled and ready to use. Enjoy!

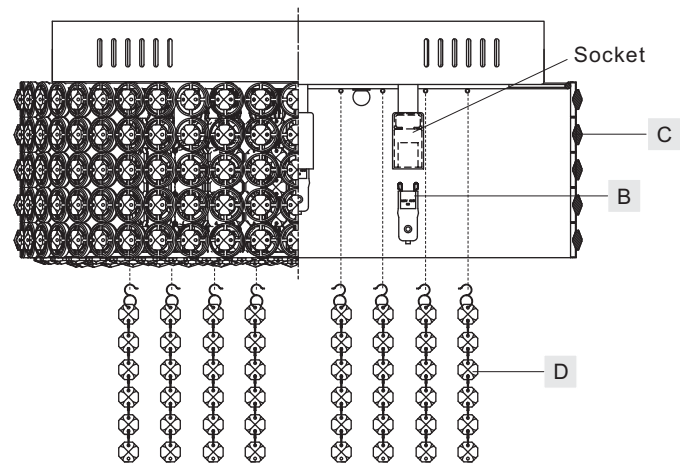

Figure 5

CAUTION FOR BULB REPLACING

- A. When replace bulb, turn off power and allow lamp to cool. For safety purpose, wear gloves and eye protection.
- B. If bulb is scratched or cracked, DO NOT use the lamp to avoid breakage during use or installation.
- C. Use only in fixtures rated for lamps wattage and voltage.
- D. Lamp operate under high pressure generating intense heat. Prevent contact with liquid and combustible materials.

PCIT1616C

FINISH: POLISHED CHROME

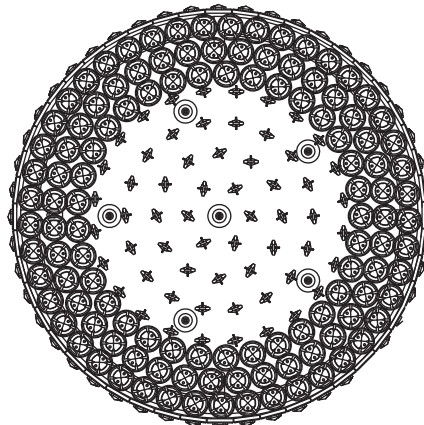
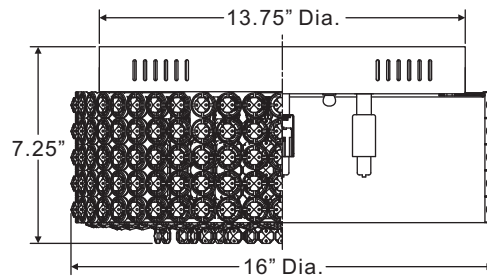
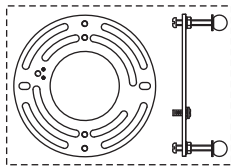

NOTE: ALL DIMENSIONS ARE ROUNDED UP TO THE NEAREST 1/4"

Thank you for purchasing a Quoizel product.
Need assistance with parts or assembly? Call Quoizel customer service at 1-800-645-3184
or visit us on-line at www.quoise.com