

**Tools Required:** Flathead screwdriver, Phillips screwdriver, pliers, wire cutters, wire strippers, electrical tape, safety glasses.

**Bulb Recommended:** (4) Candelabra Base 60W Maximum.

**Estimated Assembly Time:** 30-45 minutes

**Preparation:** Identify and inspect all parts before beginning installation. Check package content list and diagrams below to be sure all parts are present. If any parts are missing or damaged, do not attempt to assemble, install, or operate the fixture. Contact customer service for replacement parts.

**⚠ Warnings and Cautions**

Turn off electricity at circuit breaker or main fuse box before installation. Consult a licensed electrician if in doubt.

These instructions are provided for your safety. It is very important you read them completely before installing the fixture. We strongly recommend that a licensed, professional electrician perform the installation.

Disconnect fixture from power source before replacing bulbs. Make sure bulbs are given sufficient time to cool before removal. Do not subject glass parts to any shock while in operation or shattering may result.

**Package Contents**

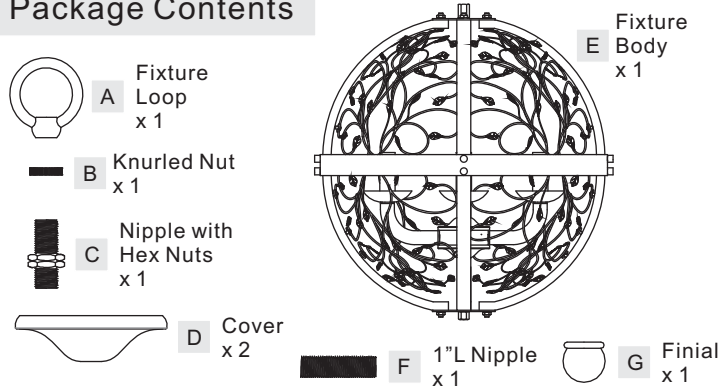

**Hardware Contents**

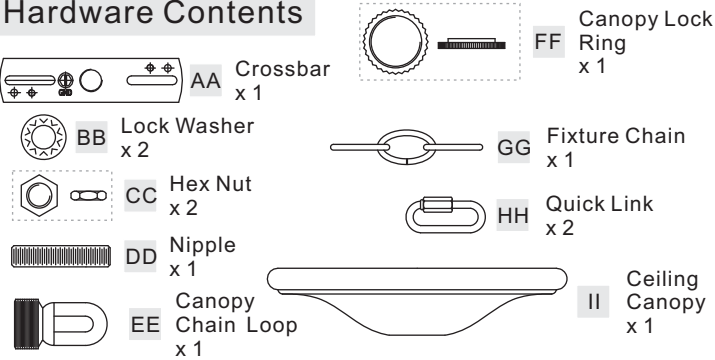

**STEP 1 – Install Crossbar**

A. Attach the Crossbar (AA) to the Outlet Box with the head of the Green Ground Screw facing you. Secure it with Outlet Box Screws (not included). Tighten until snug.

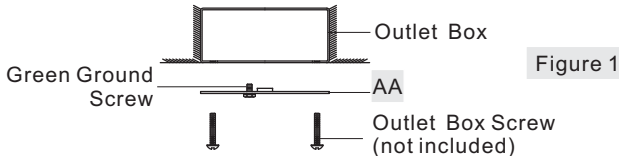

**STEP 2 – Install Canopy Chain Loop and Nipple**

\* Pliers is required for this step.

A. Thread one Hex Nut (CC) to one end of the Nipple (DD) until it is at least 0.25" from the end. Pass one Lock Washer (BB) over the end of the Nipple (DD) and thread the Canopy Chain Loop (EE) onto the

Nipple (DD). By using pliers, thread the Hex Nut (CC) against the Canopy Chain Loop (EE) and hand tighten until snug.  
B. Thread another Hex Nut (CC) to the middle of the Nipple (DD). Place another Lock Washer (BB) over the Nipple (DD) and then thread the Nipple (DD) into the Crossbar (AA) until the Nipple (DD) is about 0.375" above the Crossbar (AA).  
C. Remove the Canopy Lock Ring (FF) from the Canopy Chain Loop (EE). Place the Ceiling Canopy (II) over the Canopy Chain Loop (EE) against the ceiling to determine the correct position of the Nipple (DD). Thread the Canopy Lock Ring onto the Canopy Chain Loop (EE). Adjust the Nipple (DD) to allow the Ceiling Canopy (II) to rest against the ceiling when held in place by the Canopy Lock Ring (FF).  
D. Remove the Canopy Lock Ring (FF) and the Ceiling Canopy (II). Tighten the Hex Nut (CC) against the Crossbar (AA) to secure in place.

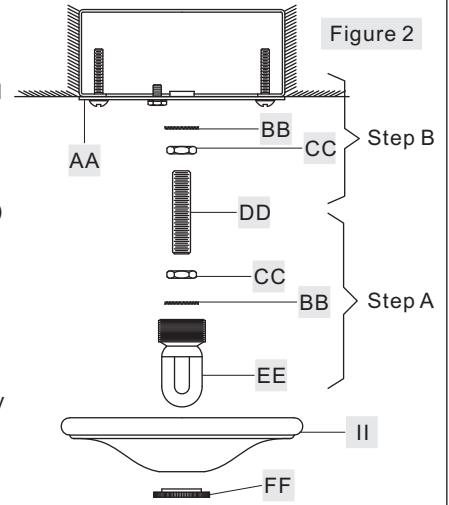

**STEP 3 – Install Fixture Loop and Cap to Fixture Body**

A. Thread one end of the Nipple with Hex Nuts (C) to hex coupling on top center of Fixture Body (E). By using pliers, thread one Hex Nut against hex coupling and hand tighten until snug.  
B. Thread another Hex Nut on Nipple (C) to proper location for one Cover (D), Knurled Nut (B) and Fixture Loop (A). Place one Cover (D) over Nipple (C) and secure with Knurled Nut (B). Tighten until snug.  
C. Thread Fixture Loop (A) onto top end of Nipple (C) and hand tighten until snug.  
D. Thread Nipple (F) into hex coupling on the bottom center of Fixture Body

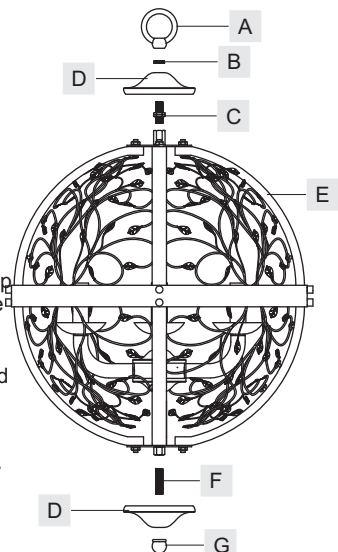

**Thank you for purchasing a Quoizel product.**  
**Need assistance with parts or assembly? Call Quoizel customer service at 1-631-273-2700**  
**or visit us on-line at www. quoizel.com**

(E) and tighten until snug. Place Cover (D) over the Nipple (F) and secure with Finial (G). Hand tighten until snug.

#### STEP 4 - Install Fixture Chain and Ceiling Canopy

A. Adjust the Fixture Chain (GG) to your desired length by removing the links if needed.  
\* Pliers is required for this step.

B. With the Fixture Chain (GG) not attached to the Fixture Loop (A) and the Canopy Chain Loop (EE), pull the supply wires through the Fixture Chain (GG) alternating links. After the wires are through the Fixture Chain (GG), pull the Supply Wires and the Ground Wire through the Canopy Lock Ring (FF) and the Ceiling Canopy (II) in order.

C. Attach one end of the Fixture Chain (GG) to the Fixture Loop (A) with one Quick Link (HH). Lift the fixture and Fixture Chain (GG) up And Attach the other end of the Fixture Chain (GG) onto the Canopy Chain Loop (EE) with another Quick Link (HH). The fixture will now hang safely. Close the chain loop at the Ceiling Canopy Loop (EE).

D. Feed the Supply Wires and Ground Wire through the Canopy Chain Loop (EE) and Nipple (DD) into the Outlet Box. Cut the wires leaving approximately 8" of wire extending from the Outlet Box.

E. Refer to Step 5 for wire connections.

F. Raise the Ceiling Canopy (II) and Canopy Lock Ring (FF) up the

Fixture Chain (GG) and over the Canopy Chain Loop (EE). Tighten the Canopy Lock Ring (FF) onto the Canopy Chain Loop (EE) until tight.

Suggested chain length for Ceiling height :  
8' ceiling : use 7 links of chain and 2 quick links  
9' ceiling : use 17 links of chain and 2 quick links  
10' ceiling : use 27 links of chain and 2 quick links

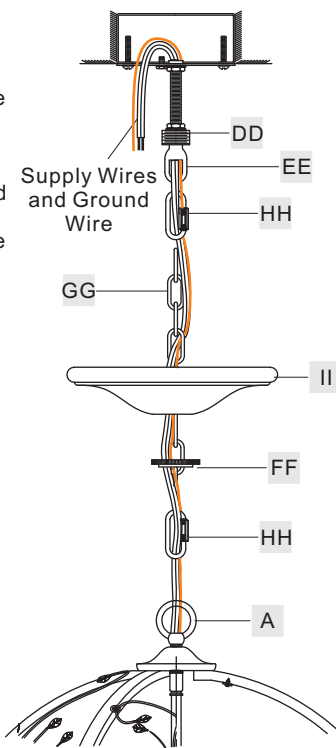

Figure 4

#### STEP 6 - Install Bulb

A. This fixture uses candelabra bulb with standard screw base. Maximum 60 watts.

B. Insert bulb and screw snugly into place.

Your fixture is now assembled and ready to use. Enjoy!

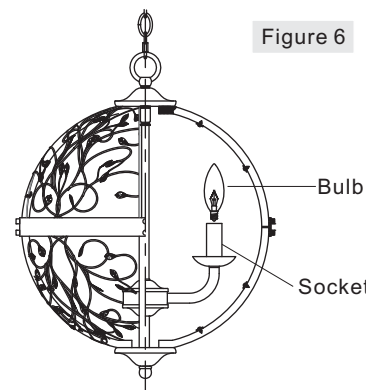
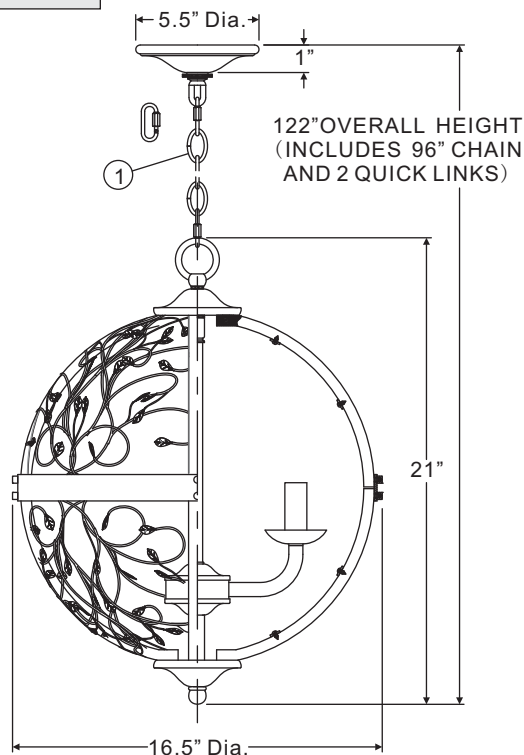
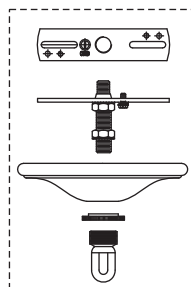

Figure 6

CHB5204DK

FINISH: DARKEST BRONZE



NOTE: ONE LIGHTS SHOWN FOR ILLUSTRATION PURPOSES ONLY.

NOTE: ALL DIMENSIONS ARE ROUNDED UP TO THE NEAREST 1/2"

#### STEP 5 - Wire Connections

A. Use standard wire connectors (not included) to make all wire connections. (Connectors are not included with fixture.) Twist connectors until wires are tightly joined together. Wrap each connection with approved electrical tape and carefully stuff all the connected wires into the Outlet Box.

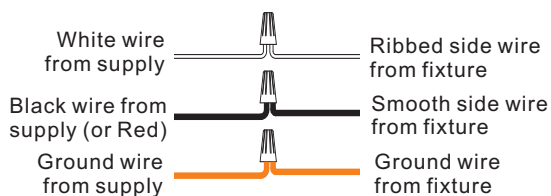

Figure 5

(4) 60W Candelabra Base Bulbs (Not Supplied)

NO.	PART NUMBER	REPLACEMENT PART	REQ.
1	M2391CHDK	CHAIN	1

Thank you for purchasing a Quoizel product.  
Need assistance with parts or assembly? Call Quoizel customer service at 1-631-273-2700  
or visit us on-line at [www.quoizel.com](http://www.quoizel.com)