

"Thomas" Corner TV/Media Stand

MS967200TX White Finish

MS977200TX Black Finish

MS987200TX Walnut Finish

MS997200TX Natural Oak Finish

Assembly Instructions



Southern
ENTERPRISES

For assistance with assembly contact:
Southern Enterprises Inc.

Customer Service 1-800-633-5096

service@seidal.com

www.seidal.com

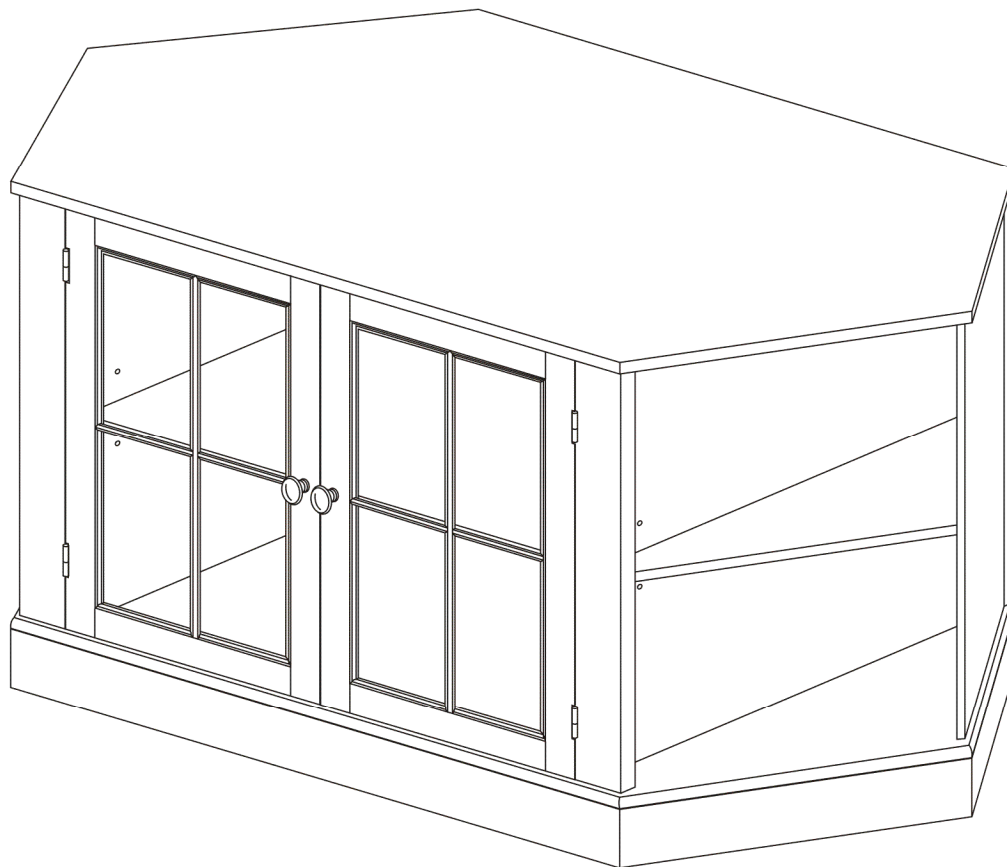



"Thomas" Corner TV/Media Stand Parts List

Please review all parts and hardware before disposing of any packaging.

Call Customer Service if missing hardware.

Using hardware that is too long will cause damage.

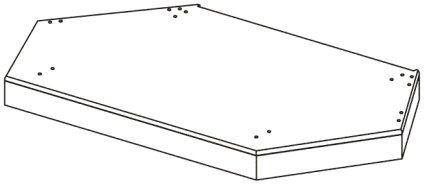
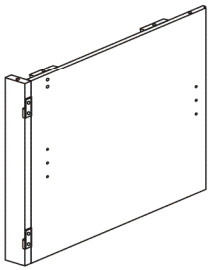
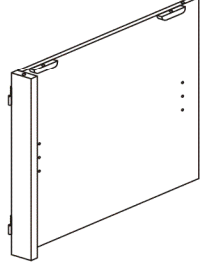
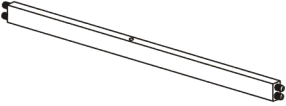
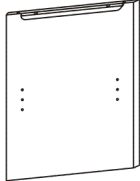
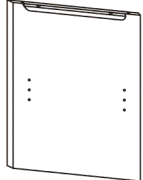
Before beginning assembly, separate each type of hardware. Carefully study the hardware diagrams below. You may receive extra hardware with your unit

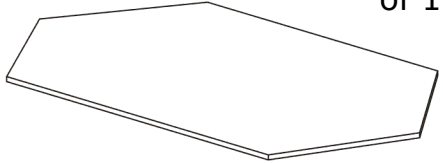
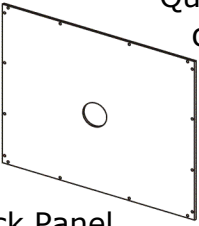
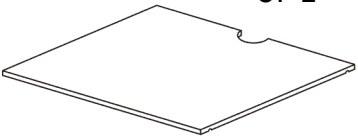
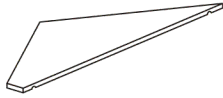
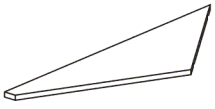
<p>A</p> <p>Quantity of 1</p>  <p>Bottom Panel</p>	<p>B</p> <p>Quantity of 1</p>  <p>Left Middle Panel</p>	<p>C</p> <p>Quantity of 1</p>  <p>Right Middle Panel</p>	
<p>D</p> <p>Quantity of 1</p>  <p>Support Rail</p>	<p>E</p> <p>Quantity of 1</p>  <p>Left Side Panel</p>	<p>F</p> <p>Quantity of 1</p>  <p>Right Side Panel</p>	
<p>G</p> <p>Quantity of 1</p>  <p>Left Door</p>	<p>H</p> <p>Quantity of 1</p>  <p>Right Door</p>	<p>I</p> <p>Quantity of 1</p>  <p>Top Panel</p>	
<p>J</p> <p>Quantity of 1</p>  <p>Back Panel</p>	<p>K</p> <p>Quantity of 1</p>  <p>Middle Shelf</p>	<p>L</p> <p>Quantity of 1</p>  <p>Left Shelf</p>	<p>M</p> <p>Quantity of 1</p>  <p>Right Shelf</p>

Care and Cleaning Instructions:

Before using, wipe with a clean, dry cloth. Periodically apply furniture wax to renew the finish. Avoid rubbing or scratching the surface with rough or abrasive objects.

For replacement parts or questions, please call Customer Service at 1-800-633-5096. Please call manufacturer for assistance, questions or parts.

Assembly Tool Required
No. 2 Phillips Screwdriver
(Not Included)

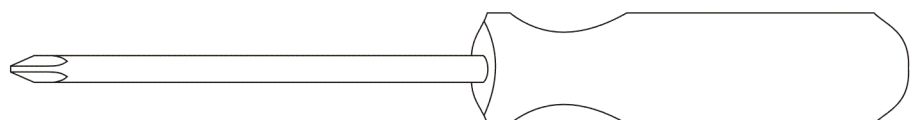





"Thomas" Corner TV/Media Stand Parts List

Please review all parts and hardware before disposing of any packaging.

Call Customer Service if missing hardware.

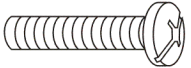
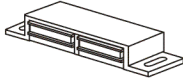
Using hardware that is too long will cause damage.

Before beginning assembly, separate each type of hardware. Carefully study the hardware diagrams below. You may receive extra hardware with your unit

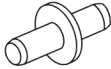
<p>(1) Quantity of 16</p>  <p>8mm x 30 mm Wood Dowel</p>	<p>(2) Quantity of 17</p>  <p>1/4" x 1-1/4" Bolt</p>
<p>(3) Quantity of 1</p>  <p>Magnet</p>	<p>(4) Quantity of 2</p>  <p>3.5mm x 15 mm Screw For Magnet</p>
<p>(5) Quantity of 16</p>  <p>3.5mm x 12 mm Screw For Back</p>	<p>(6) Quantity of 2</p>  <p>Metal Handle</p>
<p>(7) Quantity of 2</p>  <p>5/32" x 22mm Bolt For Handle</p>	<p>(8) Quantity of 12</p>  <p>Metal Pin</p>

Care and Cleaning Instructions:

Before using, wipe with a clean, dry cloth. Periodically apply furniture wax to renew the finish. Avoid rubbing or scratching the surface with rough or abrasive objects.

For replacement parts or questions, please call Customer Service at 1-800-633-5096. Please call manufacturer for assistance, questions or parts.

Assembly Tool Required
No. 2 Phillips Screwdriver
(Not Included)

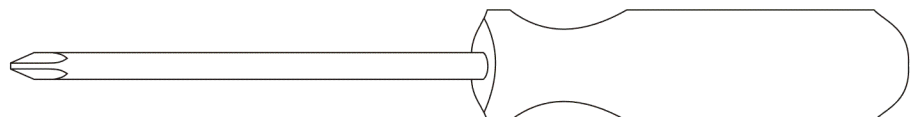

"Thomas" Corner TV/Media Stand Assembly Instructions

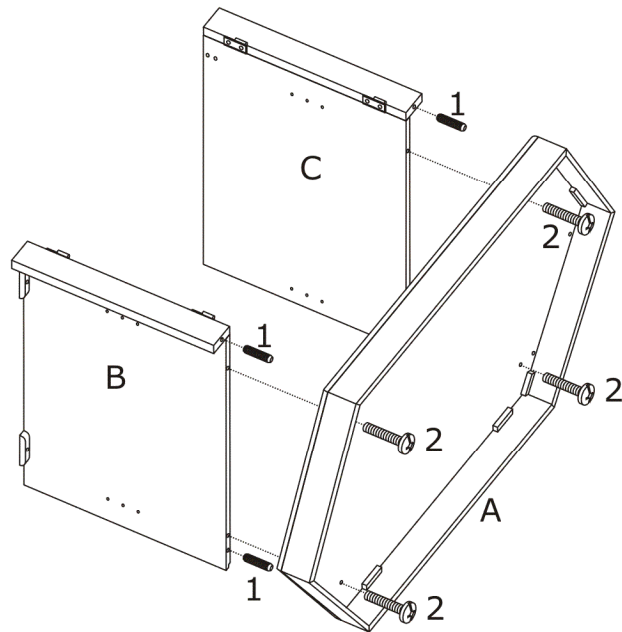

Figure 1

Assembly Instructions:

Wood may scratch easily. Be careful when assembling. Do not scratch.

Step 1. Unpack and lay parts on clean, padded surface like carpet or blanket. Check that you have all parts indicated on the front page.

Step 2. Insert the Wood Dowels(1) into predrilled holes in Left Middle Panel(B) and Right Middle Panel(C).

Step 3. Attach Middle Panels(B,C) to the Bottom Panel(A) with Bolt(2), then fasten them.

(1)		Quantity of 4
	8mm x 30 mm Wood Dowel	

(2)		Quantity of 4
	1/4" x 1-1/4" Bolt	

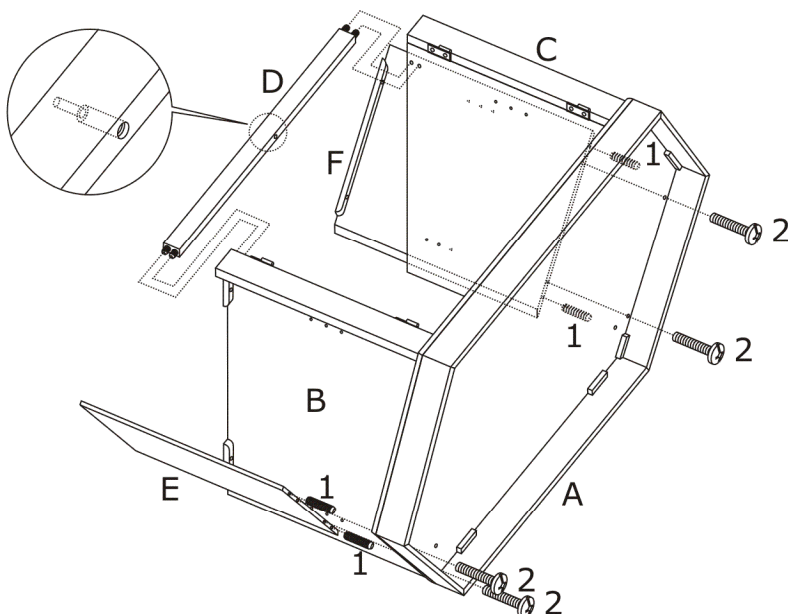



Figure 2

Step 1. Insert the Wood Dowels(1) into predrilled holes in Left Side Panel(E) and Right Side Panel(F).

Step 2. Attach Side Panels(E,F) to the Bottom Panel(A) with Bolt(2), then fasten them.

Step 3. Attach Support Rail(D) to the Middle Panels(B,C).

(1)		Quantity of 4
	8mm x 30 mm Wood Dowel	

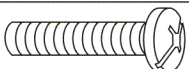
(2)		Quantity of 4
	1/4" x 1-1/4" Bolt	

"Thomas" Corner TV/Media Stand Assembly Instructions

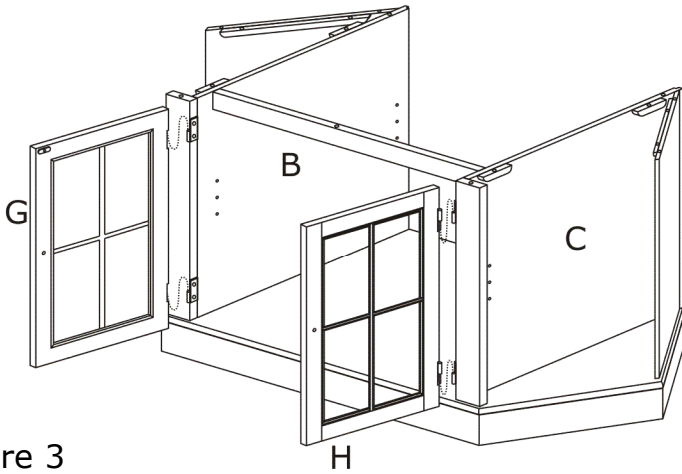

Figure 3

Step 1. Attach the Left Door(G) to the Left Middle Panel(B) and Right Door(H) to the Right Middle Panel(C).

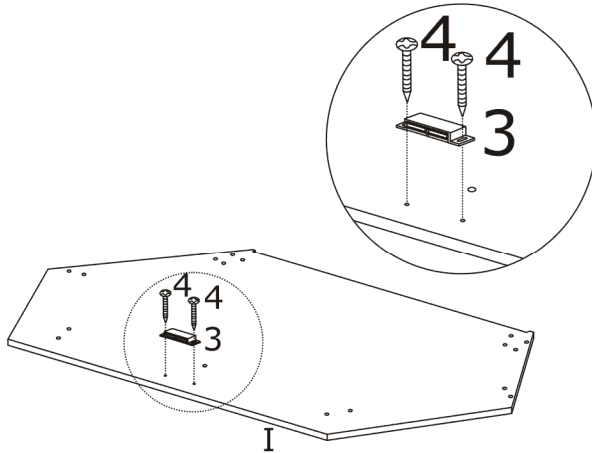
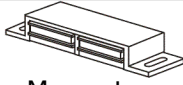

Figure 4

Step 1. Put the Top Panel (I) on the soft working surface.

Step 2. Attach the Magnet(3) to the Top Panel(I) with Screw For Magnet(4), then fasten them.

(3)		Quantity of 1
Magnet		

(4)		Quantity of 2
3.5mm x 15mm Screw For Magnet		

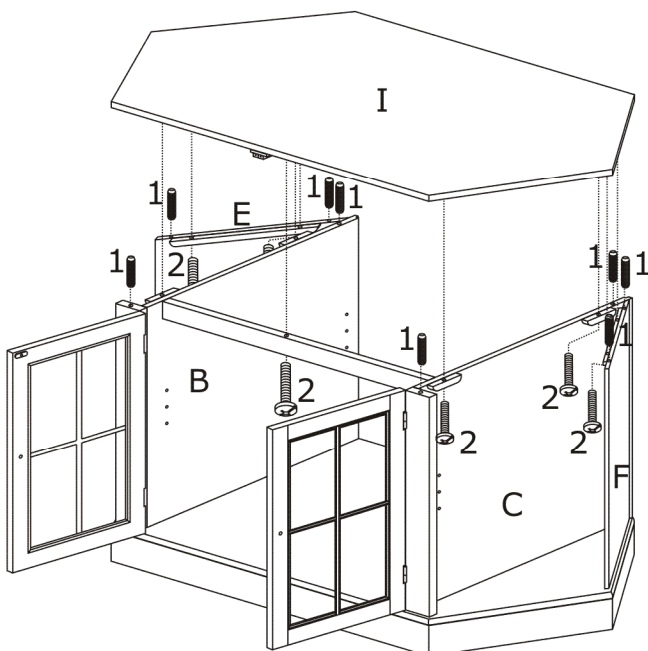

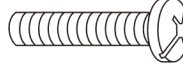

Figure 5

Step 1. Insert the Wood Dowels(1) into predrilled holes in Middle Panels(B,C) and Side Panels(E,F).

Step 2. Attach Top Panel(I) to Middle Panels(B,C), Side Panels(E,F) and Support Rail(D) with Bolt(2), then fasten them.

(1)		Quantity of 8
8mm x 30 mm Wood Dowel		

(2)		Quantity of 9
1/4" x 1-1/4" Bolt		

"Thomas" Corner TV/Media Stand Assembly Instructions

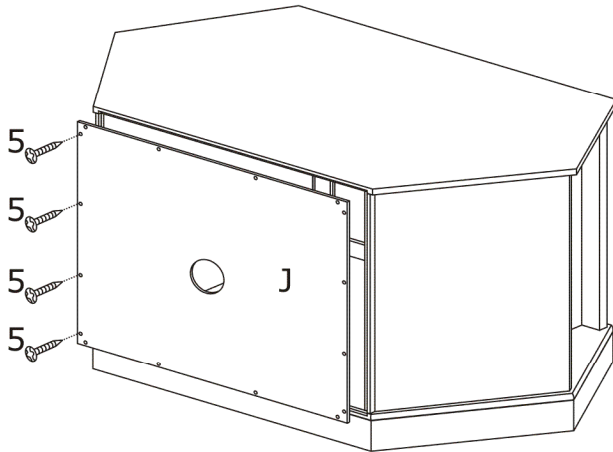



Figure 6

Step 1. Attach the Back Panel(J) as pictured with Screw For Back(5), then fasten them.

(5)		Quantity of 16
3.5mm x 12 mm Screw For Back		

Step 1. Attach Handle(6) to Doors(G,H) with Bolt For Handle(7).

Step 2. Insert Metal Pins(8) to Middle Panels(B,C) and side Panels(E,F).

Step 3. Put the Shelves (K,L,M) above the Metal Pins(8).

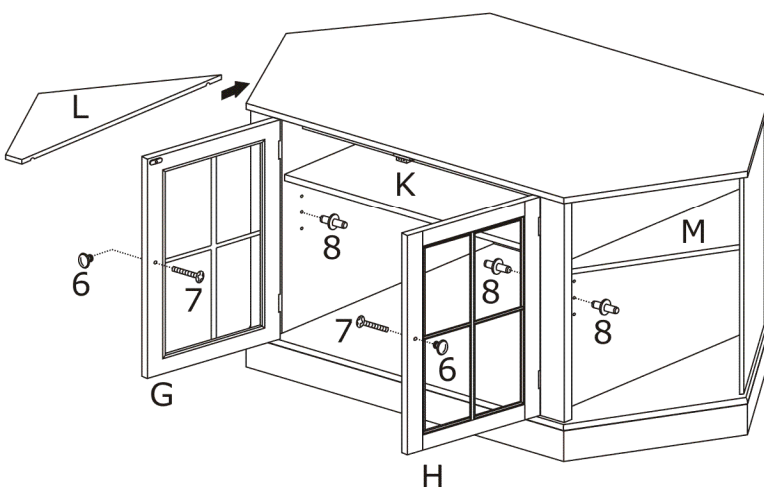



Figure 7

(6)		Quantity of 2
Metal Handle		

(7)		Quantity of 2
5/32" x 22mm Bolt For Handle		

(8)		Quantity of 12
Metal Pin		

Parts Replacement Form

Customer Information

Name _____

Address _____

City/State/Zip Code _____

Phone Number _____

Please indicate where you purchased this item: Store/Website/Catalog

Please indicate color/size/style number:

Style No	Parts Letter	Parts Description	Quantity Needed
----------	--------------	-------------------	-----------------

Please immediately examine this product carefully. Any request for missing parts or damage replacement must be received within 90 days of your receipt of the product. Replacement, if available, will be honored within this time frame. Parts will not be available for items arriving fully assembled. We do not recommend modifying product(s) and we are not responsible for any damages due to product modification(s). If damages or missing parts are not reported within 90 days of your receipt, we are under no obligation to provide parts or replacement merchandise.

Please contact Southern Enterprises at 800-633-5096 or in Dallas 972-869-0111/ 9am 4pm Mon-Fri Central time if you have product issues or email us at service@seidal.com. Please ask for customer service representative for issues involving damages or replacement parts. Please ask for technical assistance representative for any issues with product and assembly/construction.

Please contact the retailer that you purchased from for returns.



Southern
ENTERPRISES

Customer Service 1-800-633-5096
service@seidal.com
Southern Enterprises, Inc.
600 Freeport Parkway, Suite 200
Coppell, Texas, 75019



CAUTION

The top shelf of this cabinet is intended for plasma/LCD televisions having a maximum screen size of 44" and weight of 175 lb.

The top shelf is NOT INTENDED for tube televisions.

Each shelf should not be loaded with more than 20 lb.

DO NOT EXCEED RECOMMENDED LOAD. Use with products heavier than the maximum sizes and weights indicated may result in instability causing possible injury.

This unit contains a permanent warning sticker located on under side of top shelf or inside drawer.

Do not allow children under 16 years to move the cart.

Model: MS967200TX/MS977200TX/MS987200TX/MS997200TX

"Thomas" Corner TV/Media Stand

Southern Enterprises, Inc

600 Freeport Parkway,

Suite 200 Coppell, Texas, 75019

Manufacture Date: 25-12-2013