



**A&E Bath and Shower**

6400A St. Jacques West  
 Montrea, QC, Canada  
 H4B 1T6  
 www.aebath.com

Model Modèle: **Retro NF**

Freestanding bathtub

*Baignoire autoportante*

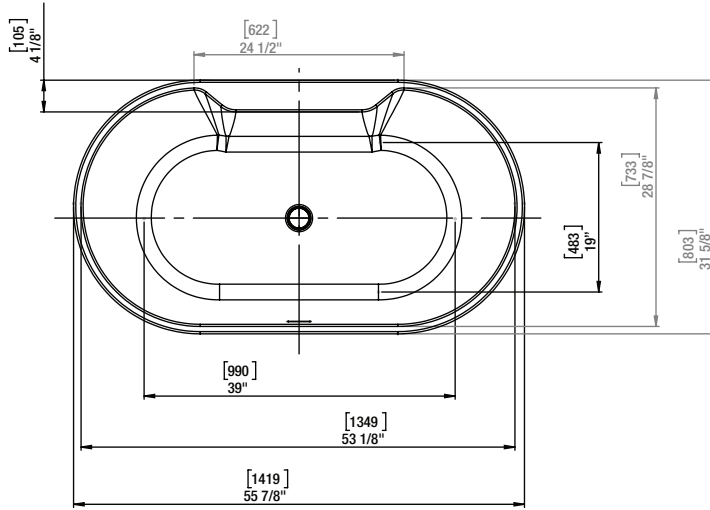

TOP VIEW VUE DE DESSUS

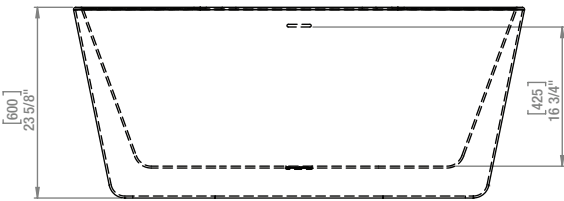

FRONT VIEW VUE DE FACE

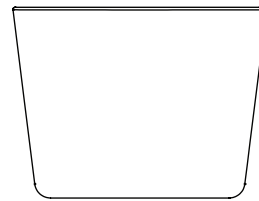

SIDE VIEW VUE DE CÔTÉ

\* Dimensions may vary +/- 1/4" (6mm) / Les dimensions peuvent varier de +/- 1/4" (6mm)

gallons to overflow /	63 gal.
packaging dimension /	59 x 35 x 27 in
approximated weight /	110 lbs
weight with water /	636 lbs
bathing well at sump /	39 x 19 in
bathing well at rim /	53 x 29 in



**Compliance Certifications:**

Uniform Plumbing Code  
 National Plumbing Code of Canada  
 CSA B45.5-17/IAPMO Z124-2017



Pure acrylic construction reinforced by fiberglass  
*Construction en acrylique renforcée de fibre de verre*

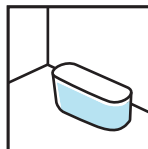

Freestanding installation  
*Installation autoportante*

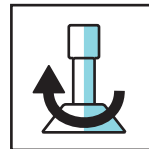

Adjustable feet  
*Pattes ajustables*

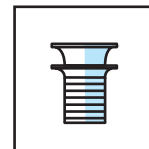

Chrome drain included  
*Drain chrome inclus*

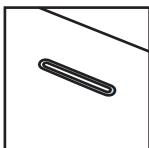

Integrated chrome linear overflow  
*Trop plein linéaire chrome intégré*



CUPC certified  
*Certifié CUPC*